

New Hampshire  
**DOT**  
Research Record

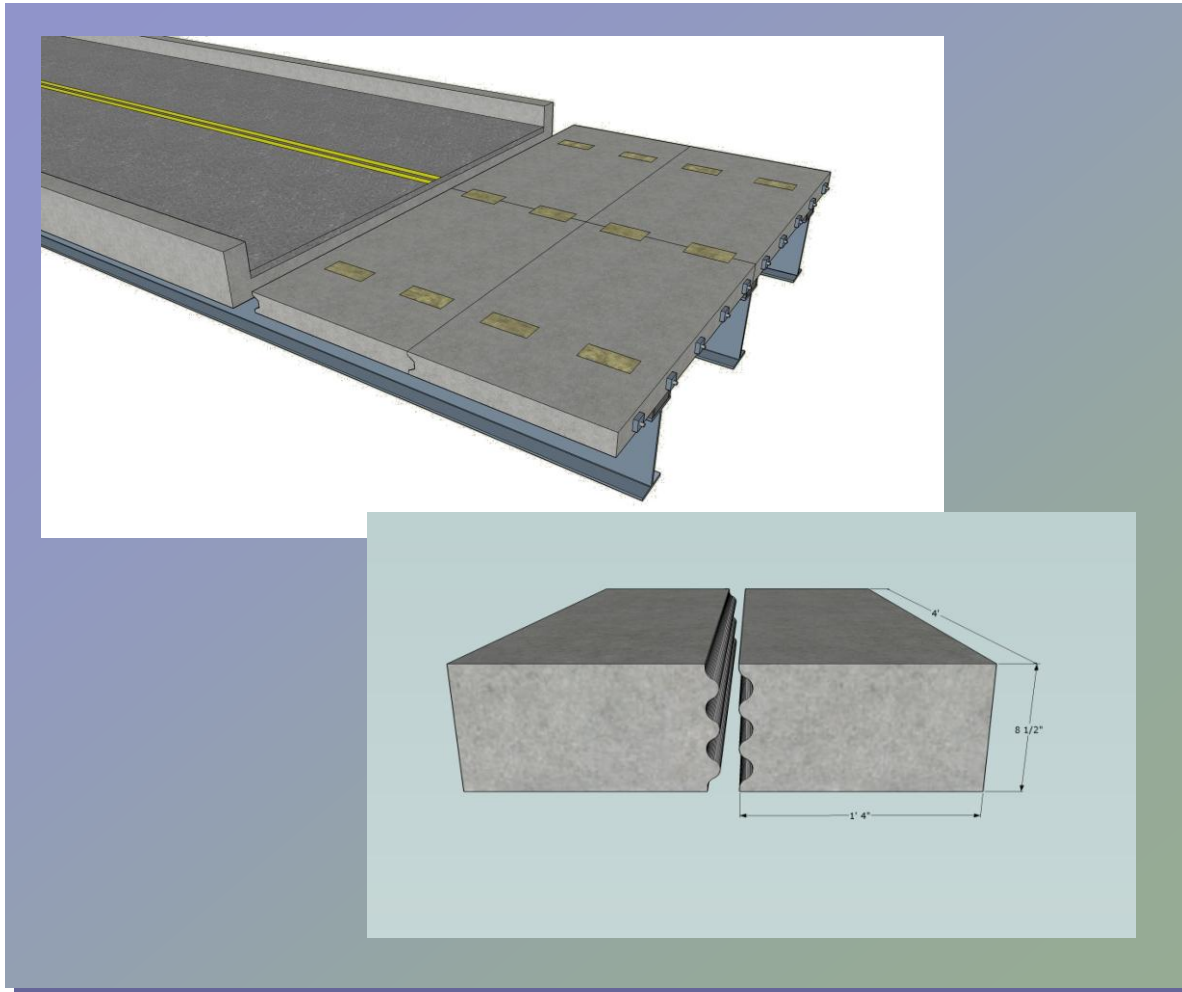

Transverse Joint Configuration  
Development and Testing  
for a  
Modular Bridge Deck Replacement

Final Report

Prepared by the University of New Hampshire Department of Civil Engineering for the New Hampshire Department of Transportation, in cooperation with the U.S. Department of Transportation, Federal Highway Administration



<b>1. Report No.</b> FHWA-NH-RD-14282T		<b>2. Gov. Accession No.</b>	<b>3. Recipient's Catalog No.</b>
<b>4. TITLE AND SUBTITLE</b> TRANSVERSE JOINT CONFIGURATION DEVELOPMENT AND TESTING FOR A MODULAR BRIDGE DECK REPLACEMENT SYSTEM		<b>5. Report Date</b> March 2011	
<b>7. Author(s)</b> Charles Goodspeed, PhD, Christopher Robert, Justin Pelletier, David Salzer, Patrick Santoso		<b>6. Performing Organization Code</b>	
<b>9. Performing Organization Name and Address</b> Department of Civil Engineering University of New Hampshire W183B Kingsbury Hall Durham, NH 03824		<b>8. Performing Organization Report No.</b>	
<b>12. Sponsoring Agency Name and Address</b> New Hampshire Department of Transportation 7 Hazen Drive, PO Box 483 Concord, NH 03302-0483		<b>10. Work Unit No. (TRAIS)</b>	
		<b>11. Contract or Grant No.</b> 14282T, X-A000(851)	
		<b>13. Type of Report and Period Covered</b> FINAL REPORT	
		<b>14. Sponsoring Agency Code</b>	
<b>15. Supplementary Notes</b> In cooperation with the U. S. Department of Transportation, Federal Highway Administration			
<b>16. Abstract</b> <p>According to the 2009 Report Card for America's Infrastructure, one in four of the nation's bridges are listed as structurally deficient or functionally obsolete, establishing a dire need for new and innovative repair and replacement techniques to improve the efficiency and state of the nation's bridges.</p> <p>Full-depth pre-cast bridge deck panels have proven to be a rapid, efficient and cost effective solution to cast-in-place bridge deck replacement techniques. However, the panel-to-panel connection for these segmental deck replacement systems requires further development and testing to improve their structural redundancy, and to streamline their installation procedure.</p> <p>Multiple transverse joint configurations have been developed, fabricated, and tested in order to evaluate their shear transfer capabilities and ease of use. It was determined that a round corrugated transverse joint configuration provided the greatest shear transfer capacity and an efficient installation procedure.</p>			
<b>17. Key Words</b> Bridge decks, Shear tests, Shear stress, Compressive stress, Transverse joints, Precast concrete pavement, Planning and design, Bridge construction, Feasibility analysis, New Hampshire		<b>18. Distribution Statement</b> No restrictions. This document is available to the public through the National Technical Information Service, Springfield, Virginia, 22161	
<b>19. Security Classif. (of this report)</b> Unclassified	<b>20. Security Classif. (of this page)</b> Unclassified	<b>21. No. of Pages</b> 101	<b>22. Price</b>

## **DISCLAIMER**

This document is disseminated under the sponsorship of the New Hampshire Department of Transportation (NHDOT) and the U.S. Department of Transportation Federal Highway Administration (FHWA) in the interest of information exchange. The NHDOT and FHWA assume no liability for the use of information contained in this report. The document does not constitute a standard, specification, or regulation.

The NHDOT and FHWA do not endorse products, manufacturers, engineering firms, or software. Products, manufacturers, engineering firms, software, or proprietary trade names appearing in this report are included only because they are considered essential to the objectives of the document.

**TRANSVERSE JOINT CONFIGURATION DEVELOPMENT AND TESTING FOR  
A MODULAR BRIDGE DECK REPLACEMENT SYSTEM**

Submitted by:  
Professor Charles Goodspeed

Researchers:  
Christopher Robert, M.S. Thesis Project  
Justin Pelletier, M.S. Researcher  
David Salzer, Ph.D. Researcher  
Patrick Santoso, Ph.D. Researcher

March 2011



DEPARTMENT OF CIVIL ENGINEERING  
COLLEGE OF ENGINEERING & PHYSICAL SCIENCES

**University of New Hampshire**

# Contents

- INTRODUCTION ..... 5
  - Previous Research at UNH..... 5
  - Research Goals and Activities..... 7
- RAPID BRIDGE DECK REPLACEMENT TECHNIQUE ..... 7
  - Replacement Technique ..... 8
    - Remove Existing Deck..... 8
    - Place Grout Dam..... 9
    - Install First Panel ..... 9
    - Insert Post-Tensioning Equipment ..... 10
    - Stress First Panel..... 11
    - Install Shear Studs, Cast Haunch ..... 11
    - Grout Post-Tensioning Bars and Ducts..... 11
    - Place Temporary Decking..... 12
    - Remove Temporary Decking, Place Grout Dam ..... 12
    - Place Second Panel..... 13
    - Install Post-Tensioning Equipment..... 13
    - Apply Panel Adhesive ..... 13
    - Snug Panels, Cure SBA ..... 14
    - Stress Second Panel..... 15
    - Install Shear Studs, Cast Haunch ..... 15
    - Grout Post-Tensioning Bars and Ducts..... 15
    - Replacement Summary ..... 15
- TRANSVERSE JOINT CONFIGURATION AND PANEL DEVELOPEMENT ..... 16
  - Transverse Joint Configuration Development..... 16
    - Shear Key ..... 17
    - Angular Corrugated ..... 17
    - Round Corrugated ..... 18
  - Shear Areas..... 18
    - Shear Area of a Butt Joint..... 19
    - Shear Area of a Shear Key ..... 19

Shear Area of an Angular Corrugated Joint.....	19
Shear Area of a Round Corrugated Joint.....	21
Summary of Shear Areas Provided by Transverse Joint Configuration.....	22
Test Panel Development and Design.....	22
Test Panel Development Based on Post-Tensioning Requirements.....	22
Test Panel Development Based on Shear Failure Control.....	23
Specimen Materials.....	23
Concrete.....	24
Carbon Fiber Reinforced Polymer (CFRP) Reinforcing Grid.....	25
Transverse Joint Material.....	26
Segmental Bridge Adhesive.....	26
Shear Key Filler Material.....	26
Specimen Formwork.....	27
Form bodies.....	28
Form Side Rails.....	29
Butt Joint Side Rail.....	29
Shear Key Side Rail.....	29
Angular Corrugated Form Side Rail.....	30
Round Corrugated Form Side Rail.....	31
Post-Tensioning Formwork.....	32
Grout Access Ports and Tubes.....	33
Test Specimen Assembly.....	34
Panel Alignment and Post-Tensioning Equipment Installation.....	34
Transverse Joint Preparation.....	34
Butt, Angular and Round Configurations.....	34
Shear Key Configuration.....	35
Stress Post-Tensioning Bars.....	36
TESTING.....	38
Development of Applied Loading.....	38
Applied Loading Schedule.....	38
Ultimate Applied Load.....	39
Specimen Test Protocol.....	39
Testing Apparatus.....	39

Loading Frame .....	40
Hydraulic Pump .....	41
Hydraulic Loading Piston .....	42
Load Application Components .....	42
Specimen Supports.....	43
Data Acquisition.....	44
Applied Load Data Acquisition .....	44
Specimen Deflection Data Acquisition .....	45
RESULTS .....	47
Ultimate Capacity .....	47
Butt Joint Configuration Failure Mode.....	48
Post-Tensioned Failure Mode .....	48
Non-Tensioned Failure Mode.....	50
Shear Key Joint Configuration Failure Mode.....	51
Post-Tensioned Failure Mode .....	52
Non-Tensioned Failure Mode.....	53
Angular Corrugated Joint Configuration Failure Mode.....	54
Post-Tensioned Failure Mode .....	54
Non-Tensioned Failure Mode.....	56
Round Corrugated Joint Configuration Failure Mode.....	57
Post-Tensioned Failure Mode .....	58
Non-Tensioned Failure Mode.....	59
CONCLUSIONS and RECOMMENDATIONS .....	61
Conclusions.....	61
Conclusions for the Post-Tensioning System .....	61
Conclusions for the Transverse Joint Material, Sikadur <sup>®</sup> 31, SBA .....	61
Conclusions for the Transverse Joint Material, SikaGrout <sup>®</sup> 212.....	61
Conclusions for the Transverse Joint Configurations.....	62
Shear Area .....	62
Tolerance Requirements .....	62
Difficulty of Fabrication .....	63
Ease of Assembly .....	63
Load Capacity.....	64



Failure Mode .....	64
Recommendations.....	64
Post-Tensioning Procedure .....	64
Transverse Joint Material .....	65
Transverse Joint Configuration.....	65
Differential Deflection Considerations .....	65
WORKS CITED .....	66
Appendix A – PANEL DESIGN .....	68
Appendix B – TRANSVERSE JOINT CONFIGURATION DIMENSIONS .....	70
Appendix C – CONCRETE MATERIAL PROPERTIES .....	73
Appendix D – DSI POST TENSIONING PRODUCT DATA SHEETS.....	80
Appendix E – TRANSVERSE JOINT MATERIAL PRODUCT DATA SHEETS .....	84
Appendix F – PROPRIETARY FORM MATERIAL PRODUCT DATA SHEETS .....	88



# INTRODUCTION

## Previous Research at UNH

During the summer of 2006, the University of New Hampshire (UNH) conducted a feasibility study to evaluate the performance of a full depth (8.50 inch) bridge deck replacement system. The study evaluated the system component performances individually as well as their contribution to the replacement system as a whole.

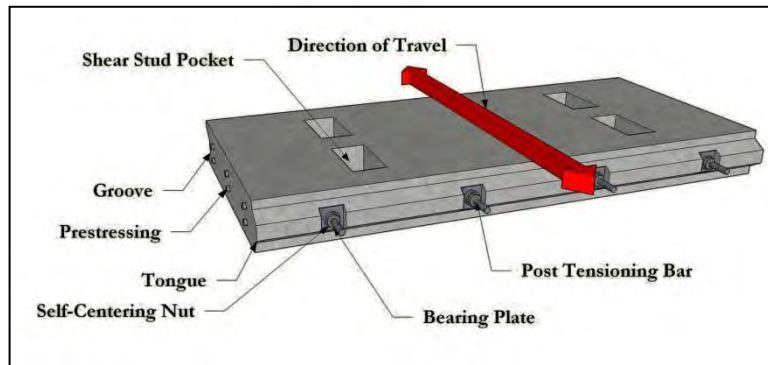

Figure 1: Typical full depth bridge deck panel

The bridge deck replacement system utilized pre-cast, pre-stressed, post-tensioned deck panels with a tongue and groove transverse joint configuration as shown in Figure 1. The panels were 8.50 inches deep, 96 inches long with widths varying from 39 inches for a tongue panel and 36- $\frac{3}{4}$  inches for a groove panel. The panels were pre-stressed in the transverse direction to traffic. Pre-stressing of the panels was achieved through the use of 5/8<sup>th</sup> inch diameter post tensioning bars in 2 layers of 3 bars each (6 bars/panel total). Leveling screws were cast into the panels to aid in placement and leveling.

The system utilized a thixotropic epoxy sealant within the transverse joint to facilitate a more rapid construction sequence than that of the typical shear key utilized in current bridge deck replacement systems. The thixotropic epoxy was evaluated for its ability to be placed to the required thickness without sagging or sloughing off of the vertical surfaces of the transverse joint.

The deck panels were post-tensioned together with 1 inch diameter threaded steel bars parallel to the direction of traffic. The post tensioning system utilized was Dywidag System International's (DSI) THREADBAR<sup>®</sup> system. The system was evaluated for its ability to work in concert with the other deck replacement system components as well as its ability to achieve the required compressive forces within the decking.

A closed cellular adhesive backed foam was utilized to fabricate the grout dam to form the haunch. The closed cellular foam's ability to adhere to the steel girders of a bridge, its rapid manner of installation, and its ability to survive the haunch casting, was evaluated.

The replacement system components were then installed on two steel girders, and their performance was noted. With the deck replacement system now fully constructed, a simple bending test was performed to evaluate the overall system performance when subjected to service loads. A static load was applied to the midspan of one deck panel approximately 6 inches away from the transverse joint. As static loading was carried out, the deflections of the individual panels were recorded using analog dial gauges placed at pre-determined locations along the transverse joint of the panels (Briggs, 2007). The panels were cyclically loaded three times with the deflection readings recorded at the end of each cycle. Following the third cycle, the panels were then loaded to the ultimate capacity of the system, defined as the ultimate loading capacity of the loading apparatus or significant failure in the panels (Salzer, 2008).

After testing of the first set of tongue and groove panels was completed, the second set of panels were rotated 180° and tested as a butt joint for the transverse joint configuration. The same installation procedures were followed for the second test, and the panels were then subjected to the cyclic and ultimate loadings that the first set of panels were subjected to.

The feasibility study determined that the THREADBAR® post-tensioning system was able to achieve the required compressive forces, and the system components provide by DSI were easily installed (Salzer, 2008). However, cracking and spalling was observed during the post-tensioning operation. This was a result of misalignment and insufficient tolerance in the tongue and groove joint. The cracking was a result of excessive stress in the top and bottom (butt areas) of the tongue and groove joint, inducing tension in the groove panel, cracking the concrete (Salzer, 2008). The spalling indicated a lack of sufficient tolerances in the fabrication and alignment of the panels. The incorrect fabrication and alignment tolerances were compounded during post-tensioning, creating a location of extreme stress, resulting in the observed spalling (Salzer, 2008).

The thixotropic epoxy utilized in the transverse joint was applied successfully and performed well. The epoxy was a special mix for this application, with a high compressive strength, low modulus and six hour pot life. Placement proved to be quicker, easier, and more successful with a gloved hand as opposed to trowels and hand tools (Salzer, 2008)

The feasibility study determined that the differential deflection between adjacent panels for the tongue and groove transverse joint configuration was much less than that of the butt joint configuration. This was a result of the concrete-on-concrete shear transfer mechanism in the tongue and groove and the low modulus of the epoxy in the butt joint (Salzer, 2008). However, the tongue and groove joint was very difficult to fabricate, form, and construct due to the tight tolerances required (Salzer, 2008).

## **Research Goals and Activities**

This research project stems from the recommendations determined in the feasibility study done previously at UNH. As stated above, the bridge deck replacement system was found to be a viable solution to the need for new and innovative construction techniques. However, before the system is utilized in actual replacement projects, study and development of particular components of the overall system needs further evaluation.

This research focuses on the development and testing of the transverse joint for the bridge deck replacement system. It was shown during the feasibility testing that a transverse joint configuration that provides an increased shear transfer mechanism through concrete-on-concrete bearing provides less differential displacement between adjoining panels than a configuration that is lacking this shear transfer mechanism (Salzer, 2008). However, the transverse joint configuration must also provide the appropriate design and construction tolerances to prevent excessive stresses resulting in damage to the deck panels during the post tensioning operation as was observed in the tongue and groove test panels. The joint configuration must also consider the time and effort required to fabricate and install the panels.

This research develops and suggests four varying transverse joint configurations to be fabricated and tested. The fabrication efforts were critiqued for each configuration. Test specimens for each configuration were cast and assembled according to the procedures noted in Testing section. The materials utilized within the transverse joint of each configuration will be revisited and critiqued according to their ease of installation and overall performance. The post-tensioning operation was also reevaluated to develop post-tensioning protocols that should be followed to ensure that the required compressive forces can be achieved within the panels and will not damage the panels during assembly.

A direct shear test was developed to induce shear forces through the transverse joint of the assembled test specimens. Each test specimen was subjected to static load tests and its performance was quantified based upon ultimate capacity and failure modes.

Upon completion of the testing, the joint configuration that demonstrated the best overall performance, based upon shear testing results as well as ease of fabrication and installation, was suggested for use in further testing, fatigue loadings, of the bridge deck replacement systems.

## **RAPID BRIDGE DECK REPLACEMENT TECHNIQUE**

UNH has been developing rapid construction techniques and procedures over the past decade. The rapid construction technique developments rely heavily on the use of pre-cast concrete structural elements, greatly improving the quality of the finished product and significantly reducing the time required to replace a bridge deck utilizing cast-in-place methods.

## Replacement Technique

The following section describes the deck replacement procedure used for the removal of an existing bridge deck. Figure 2 depicts the model bridge that will be used in the description of the replacement procedure. For simplicity, the model bridge is comprised of three steel stringers, a mildly reinforced cast-in-place deck, and an asphalt wearing surface. The proceeding figures depict the replacement deck panels with a tongue and groove transverse joint configuration.

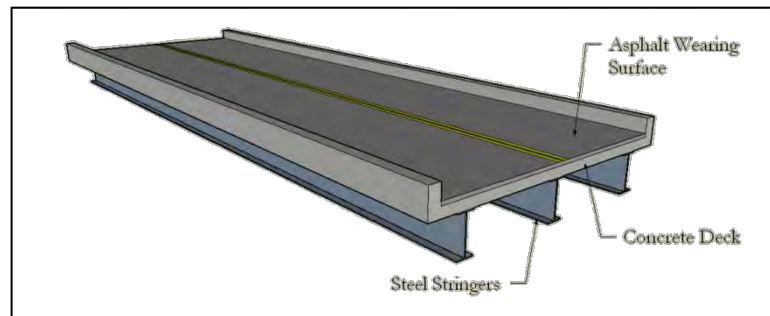

Figure 2: Model bridge for deck replacement procedure

### ***Remove Existing Deck***

The existing deck must be removed prior to the placement of any new deck panels. The deck may be removed by jack hammering away sections of the deck above the girders and burning off the existing shear studs welded to the girders. An alternative method includes cutting longitudinally along the top sides of the flange of the steel stringers with a band saw freeing the shear studs connecting the stringers to the deck. At selected transverse locations, cross cutting the deck allows for large sections of the decking to be removed at one time with the aid of a crane. The selected transverse location varies from bridge to bridge, with girder spacing and span lengths both affecting the composite action between the bridge deck and stringers. Great care must be taken in determining the capacity of the bridge with large sections of decking removed and the presence of construction loads not typically experienced by the non-composite superstructure.

Ideally, replacement of the decking begins at one end of the bridge and progresses to the opposite end. Sections of removed decking are withdrawn to the opposite end of construction as the replacement deck panels arrive from the end of progression. This linear system of deck removal and replacement prevents either phase of construction from impeding the progress of the other. Figure 3 shows the model bridge with a section of decking removed.

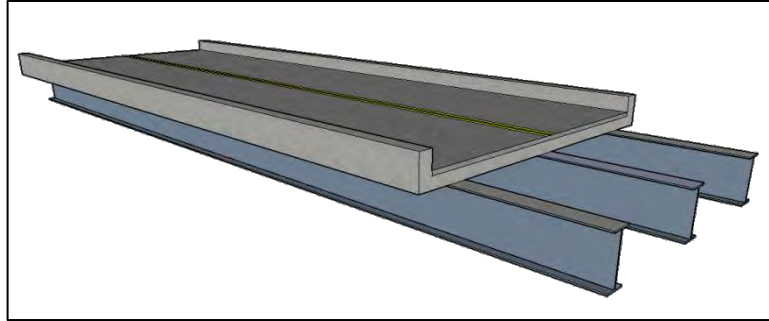

Figure 3: Model bridge with section of deck removed

### ***Place Grout Dam***

Once a section of decking has been removed, the top flange of the girders should be cleared of any debris or corrosion exposed after the deck removal. The haunch is then formed with the placement of the grout dam. The haunch is a cementitious grout and fills the void space between the top flange of the steel girders and the bottom of the pre-cast replacement panels. To facilitate the rapid construction of the deck replacement system, an adhesive-backed, closed cellular foam material is used for the grout dam. The foam is cut into 1.5 inch wide strips and adhered to the perimeter of the top flange of the steel girders. Since the haunch must be placed prior to the bridge being re-opened to traffic, the grout dam should only be placed in the areas that will be covered by the newly installed panels. Figure 4 shows the model bridge with the grout dam in place.

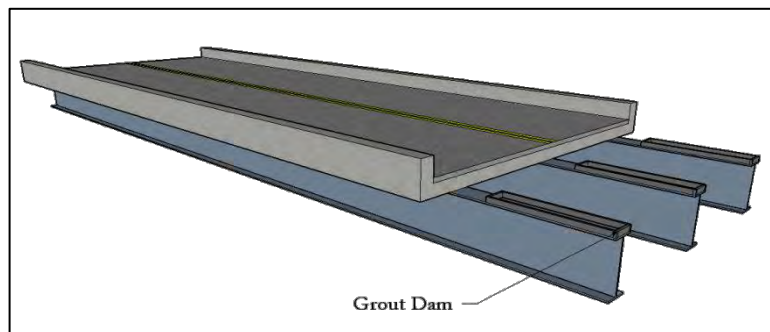

Figure 4: Model bridge with grout dam installed

### ***Install First Panel***

Due to their location, the end deck panels vary slightly from the other panels in the replacement system. Since the end panels will only abut one other deck panel, one face of the panel will be a butt end and the other will have a corrugated face to interlock with the proceeding panel of the system. Figure 5 depicts an end panel.

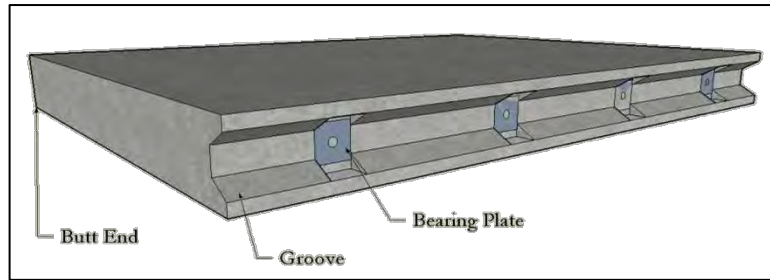

Figure 5: End panel

Once the grout dam has been installed, placement of the deck panels can begin. An end panel is brought in and set in place. Each panel is fabricated with leveling screws that rest on the top flange of the steel beams and are turned accordingly to level the panel. At this point in time, the panels cannot support traffic loads. Figure 6 shows the model bridge with two end panels (1-A, 1-B) set and leveled in place. Panels 1-A and 1-B are cast with shear stud pockets. These pockets provide access to the tops of the steel beams. Through these pockets, shear studs are welded to the top flanges of the steel stringers, which aids in the composite action between the stringers and the bridge deck.

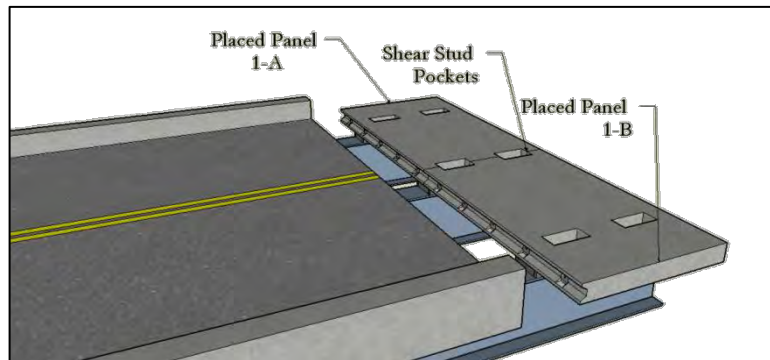

Figure 6: Model bridge with end panels set and leveled

### ***Insert Post-Tensioning Equipment***

The post-tensioning bars and bearing plates are now ready to be installed. The THREADBAR® post-tensioning system being utilized in this model is a proprietary product of Dywidag Systems International, Inc. (DSI). THREADBAR® utilizes 150 ksi ultimate strength, hot-rolled threaded steel bars with various mechanical components. The threaded bars have deformations acting as threads that allow for nuts and couplers to be added to them to allow for multiple bars to be attached and stressed together.

With the post-tensioning bars cut to the required length and installed, the bearing plates and nuts are placed. The end panels of the deck system are cast with recesses in the faces to allow for bearing plates to be placed within them. Figure 7



shows an end view of the model bridge with the post-tensioning equipment installed in the end panels.

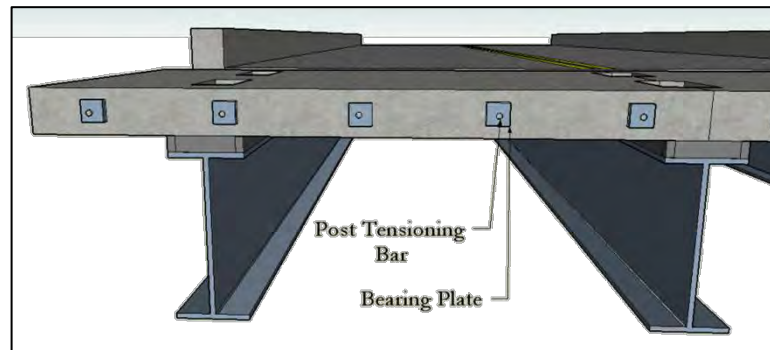

Figure 7: End view of model bridge with installed post-tensioning equipment

### ***Stress First Panel***

For simplicity, assume the only one end panel can be installed during this first night's work shift. The panels are now ready to be post-tensioned to induce stress in them in the longitudinal direction of the bridge. If multiple panels are able to be placed, the panels must be post-tensioned after all panels have been placed for the night.

### ***Install Shear Studs, Cast Haunch***

The shear studs are welded to the top flanges of the bridge girders through the openings provided by the shear stud pockets. The installation procedure for the shear studs is typically determined by the contractor, but studs are most likely installed utilizing stud guns or field welds.

With the shear studs installed, the haunch is now ready to be cast. The grout used for the haunch is placed through the shear stud pockets cast in the panels. The grouted haunch and shear studs provide the panel-to-girder connection required to achieve composite action by the segmental deck panels. The grout dam and deck panels provide the formwork for the haunch. Once the haunch has cured, the panels are now able to fully support traffic loads. The grout dams can either be removed or left in place as desired.

### ***Grout Post-Tensioning Bars and Ducts***

With the end panels now fully installed, and the haunch and shear studs grouted, the post-tensioning bars are grouted solid to protect them from corrosion and provide dowel-bar action within the deck to increase the overall stiffness of the

replacement system. Bar grouting can be done with a high-flow, cementitious grouting material and pumping system. Alternative to the cementitious based grout material, a methyl methacrylate (MMA) compound may be injected into the post-tensioning ductwork.

Post-tensioning bar grouting is best accomplished with a vacuum, pressure injection system. A vacuum is applied to the ductwork in order to evacuate air within the ducts. With the air vacant from the ductwork, the grout material is then pressure injected into the post-tensioning ductwork via the grout access ports. The vacuum, pressure injection method insures that there are no gaps or cavities in the grouted ductwork that would allow for bar corrosion to take place.

### ***Place Temporary Decking***

While the placement of deck panels is occurring, the next section of existing decking can be removed concurrently. The use of temporary decking may be installed to span gaps between the newly installed panels and the decking being removed in order to re-open the bridge to traffic during the day. However, caution must be used and an extensive investigation must be done prior to allowing such temporary decking to be implemented. As discussed earlier, the possibility of a reduction in the bridge's load carrying capacity may occur with the loss of composite action between the beams and decking during deck replacement. Figure 8 shows the model bridge with temporary steel decking spanning a construction gap.

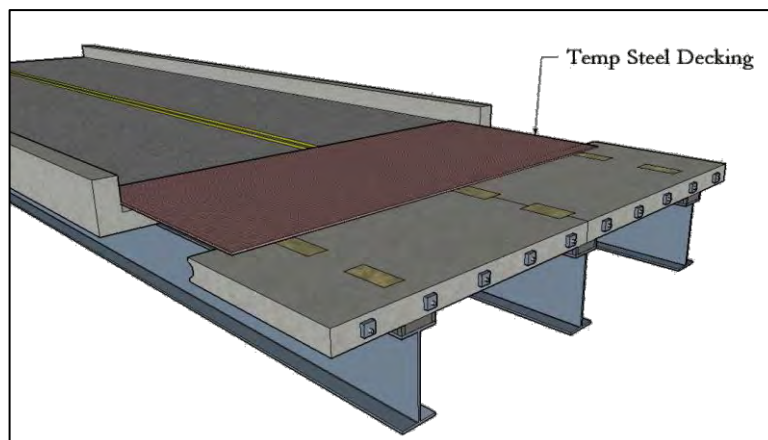

Figure 8: Temporary steel decking spanning construction gap

### ***Remove Temporary Decking, Place Grout Dam***

As the second night of work begins, the temporary steel decking may be removed to re-expose the construction gap between the previously placed replacement deck panels and the decking in the process of being removed. Work

should continue on the demolition side of decking and replacement will resume with the placement of the next section of grout dam. Again, the grout dam is applied to the perimeter of the top flange of the beams where new panels are placed during this work shift. Figure 9 shows the previously installed panels and the next section of newly installed grout dam.

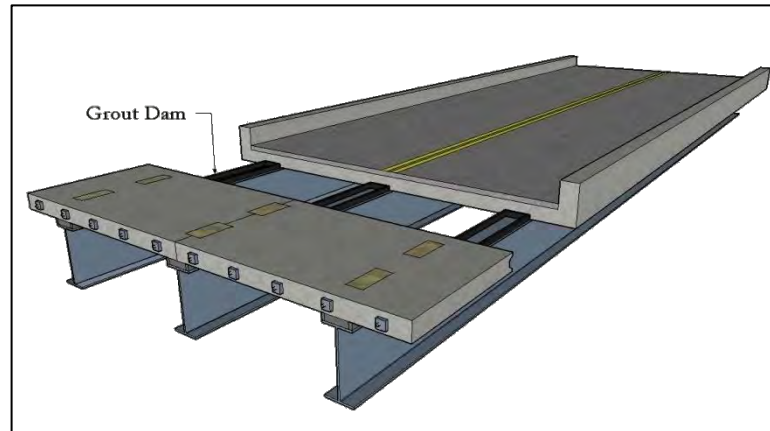

Figure 9: Newly installed grout dam

### ***Place Second Panel***

Once the grout dam has been installed, the second section of deck paneling is ready to be placed. The new sections of panels are brought in and placed approximately one foot from the previously installed panels.

### ***Install Post-Tensioning Equipment***

The post-tensioning bars, couplers, and bearing plates are inserted into the second set of deck panels. The couplers splice the bar ends of the installed panels to the post-tensioning bars of the panels currently being installed. Post-tensioning bar lengths will vary dependent on the number of panels being installed. According to DSI, bar lengths of up to 60 feet are available upon request. Whenever possible, single bar lengths should be used when passing through multiple panels.

### ***Apply Panel Adhesive***

A structural adhesive is applied to each face of the transverse joint to ensure that it is adequately sealed and any deviations in the joint configuration are corrected. The structural adhesive, Sikadur® 31, Segmental Bridge Adhesive (SBA), that was used is a proprietary product developed by the Sika Corporation. The SBA is specifically developed for pre-cast, segmental bridge construction techniques. The SBA aids in the alignment of pre-cast elements as well as creates a durable, water-tight seal between elements.

Application of the SBA is typically done with a gloved hand. It is applied to each face of abutting panels so that there is an approximately 3/16 inch thick layer of material on each face. The SBA is thixotropic in nature, which aids in the application of the material to the vertical faces of the panels. The SBA has a pot life of approximately two hours, making it ideal to be mixed in small batches and applied to the faces of the deck panels as they are placed on the bridge girders. Figure 10 shows a close-up of two opposing panel faces with the SBA applied. Also visible in this figure are the post tensioning bars and mechanical couplers used to splice bar ends together. The SBA is depicted as yellow in the figure, but actually has a gray color to match the pre-cast elements.

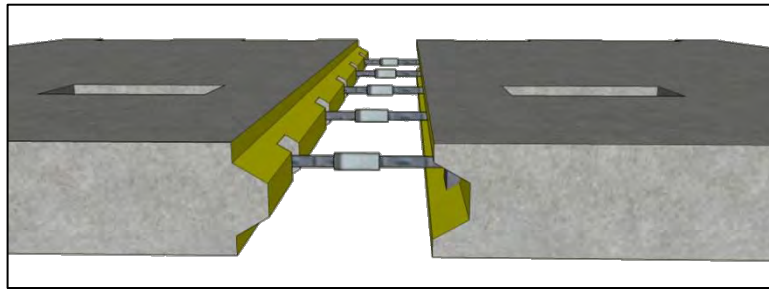

Figure 10: Close-up of transverse joint with post tensioning equipment and SBA

### ***Snug Panels, Cure SBA***

After placing the SBA, the panels are now ready to be brought together. Bring adjoining panels together so that they are snug tight. This must be done within the pot life of the SBA. During the snug tightening operation, the SBA is allowed to flow within the transverse joint and fill any gaps or deviations within the joint that is present due to the fabrication and construction tolerances. Any excess SBA is squeezed out the top, bottom, and sides of the panels and is easily removed prior to setting. The SBA is allowed to cure prior to fully stressing the panels. Figure 11 shows a close-up of the transverse joint of adjoining snug tight panels.

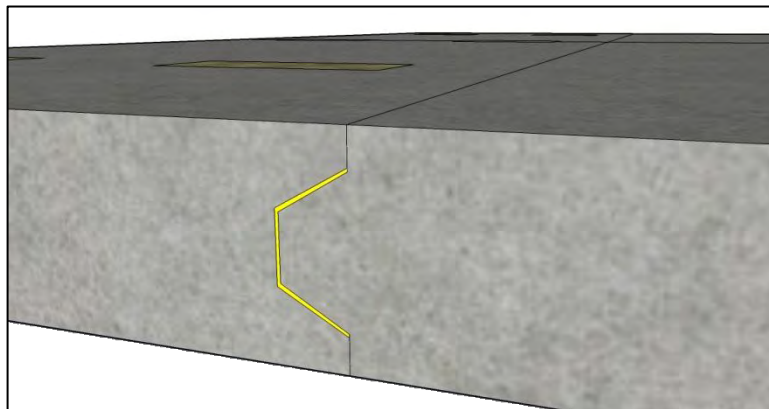

Figure 11: Close-up of snug tight panels

### ***Stress Second Panel***

Once the SBA has cured, the second panel is post-tensioned. Post-tensioning should start from the center of the deck panels and progress outward toward the panel ends to reduce the possibility for eccentricities during the post tensioning operations. For efficiency, multiple stressing jacks may be utilized during this procedure.

### ***Install Shear Studs, Cast Haunch***

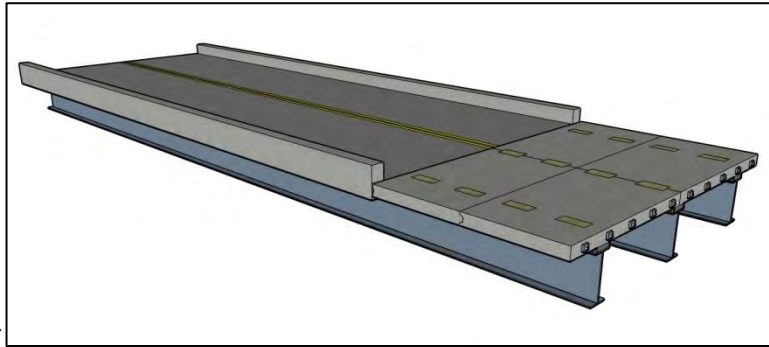

Figure 12: Two installed sections of decking

### ***Grout Post-Tensioning Bars and Ducts***

With the shear studs and haunch cast, the post-tensioning bars and ducts are ready to be grouted. Section 2.1.7 (Robert, 2009) describes the details and procedures pertinent to this step.

### ***Replacement Summary***

This construction sequence is followed methodically until all sections of the bridge deck have been replaced. The process is a very organized, timely, stepwise procedure that ensures a successful deck replacement. Figure 13 depicts the model bridge with the deck replacement completed.

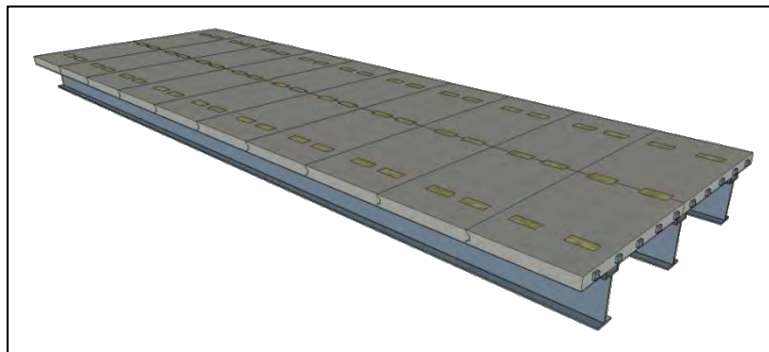

Figure 13: Completed model bridge

# TRANSVERSE JOINT CONFIGURATION AND PANEL DEVELOPEMENT

## Transverse Joint Configuration Development

As a result of the feasibility study conducted previously at UNH, it was determined that a more shear redundant transverse joint configuration was necessary to increase and make more durable the shear transfer mechanism between adjacent panels. The ideal joint configuration would have the constructability of a butt joint with the increased shear transfer mechanism provided in the tongue and groove joint tested previously (Salzer, 2008). As a result, the following joint configurations described below were developed. Preliminary evaluation determined the configurations worthy of further investigation, development and testing. They have been developed to maintain ease and speed of construction to provide sufficient shear transfer between adjacent panels, over a range of fabrication costs.



Figure 14: Butt joint configuration

### **Butt Joint**

The butt joint configuration, depicted in Figure 14, is the simplest and easiest configuration for fabricators to manufacture and construction crews to install. It is comprised of the abutting vertical faces of adjacent pre-cast deck panels. However, the butt joint does not provide any shear transfer redundancy, concrete-on-concrete bearing, due to the lack of protrusions and undulations within the configuration.

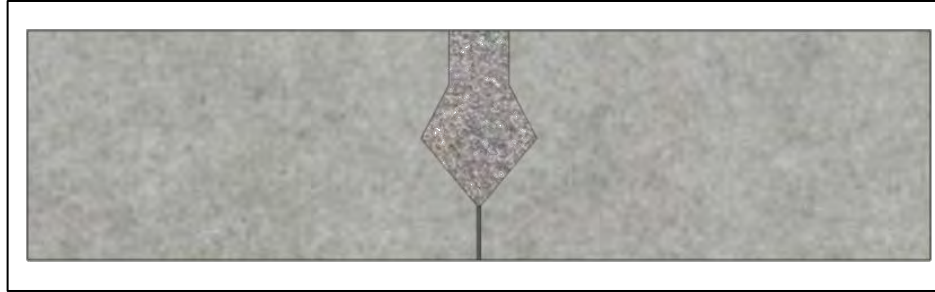

Figure 15: Shear key joint configuration

### ***Shear Key***

The shear key joint configuration, depicted in Figure 15, is the only female-female transverse joint configuration investigated in this research project. The shear key configuration is the current standard transverse joint configuration used by the NHDOT for bridge deck replacement panels. The shear key is more difficult to construct than the butt joint configuration. However, due to the symmetric nature of the joint configuration, only one transverse joint form is required to fabricate adjacent deck panel faces.

Due to the female-female nature of this configuration, there is an obvious lack of concrete-on-concrete bearing for the shear transfer mechanism. The shear transfer for a shear key lies within the post tensioning and the keyway filler material. The filler material is high performance grout placed in the void formed in adjacent panels. The combination of the joint configuration and grout filler material facilitates the concrete-on-concrete bearing action for shear transfer to occur between adjacent panels. The requirement of grouting the shear key is time consuming. The time to perform the extra steps required in preparing the key grout, placing the grout and waiting for the grout to cure sufficiently is a major drawback to this configuration when it is compared to the installation procedures of the other joint configurations.



Figure 16: Angular corrugated joint configuration

### ***Angular Corrugated***

The angular corrugated transverse joint configuration, depicted in Figure 16, is a male-female joint that provides the concrete-on-concrete bearing shear transfer mechanism not present in the butt joint or shear key configurations. The angular corrugated joint configuration requires more skill, effort and precision during



fabrication of the form than required for the butt joint or shear key. Fabrication tolerances are critical to ensure that the adjacent panel's angular corrugations align correctly when installed in the field. The higher required precision also increases the risk of difficulties arising due to panels warping during curing.

The multiple protrusions and undulations create a joint that is two times more redundant than that of a typical tongue and groove type configuration, since there are twice as many tongues and grooves present. Along with the concrete-on-concrete bearing, the angular corrugated configuration also utilizes a structural adhesive within the joint and post tensioning to aid in the shear transfer mechanism.

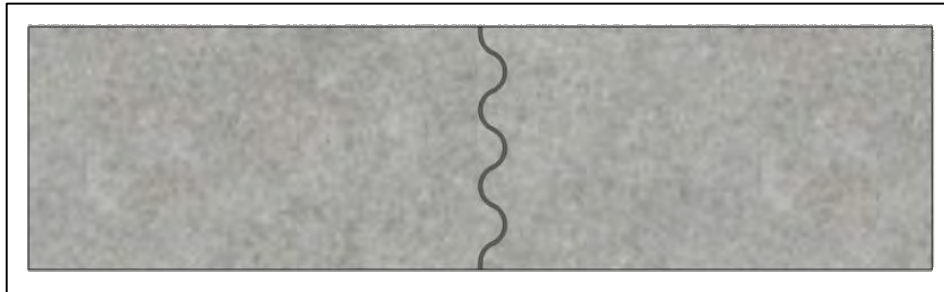

Figure 17: Round corrugated joint configuration

### ***Round Corrugated***

The round corrugated transverse joint configuration, depicted in Figure 17, is another male-female joint type. The multiple protrusions and undulations provide an increased concrete-on-concrete bearing surface, facilitating the shear transfer mechanism between adjacent panels. Although the round corrugated configuration provides the greatest concrete-on-concrete bearing between adjacent panels, it is by far the most difficult to fabricate and install. Fabrication tolerances must be strictly followed to ensure the correct alignment of abutting panels in the field. With the correct fabrication tolerances met, the round corrugations aid in panel alignment through a self-centering action as the panel corrugations are allowed to slip over each other and into their correct position. This self-centering feature reduces stress concentrations induced during assembly of the deck panels.

Along with concrete-on-concrete bearing, the shear transfer mechanism between panels is supplemented by a structural adhesive within the joint as well as post tensioning reinforcement.

### **Shear Areas**

Each transverse joint configuration provides a different amount of shear area through the depth of the panel. The shear area is defined as the provided depth of panel resisting shearing forces resulting in differential panel displacement. Shearing forces result from the deck panels being subjected to moving vehicular loads. As a vehicle progresses transversely across a deck panel and crosses onto the next panel, the deflection of the loaded panel presses down on the adjacent panel, generating



shearing forces through the depth of the transverse joint. These shearing forces are resisted via the joint configuration, joint filler or structural adhesive and post tensioning bars. The shear areas are reported in inches per unit length of the joint.

***Shear Area of a Butt Joint***

Due to the lack of concrete-on-concrete bearing area for the butt joint configuration, there is no effective shear area providing shear resistance. As a vehicular load traverses from one panel to the next, the panels are able to deflect separately from each other, with only the post-tensioning and adhesive transferring the shear loading. Figure 18 depicts the resultant panel deflection from the left hand panel exposed to such a shearing load.

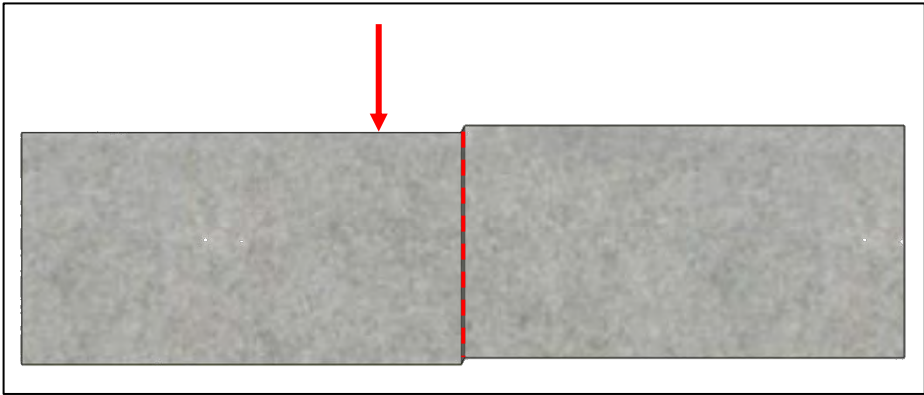

Figure 18: Butt joint shear area

***Shear area provided by butt joint configuration = 0.00 inches***

***Shear Area of a Shear Key***

Due to the lack of concrete-on-concrete bearing area for the shear key configuration, the effective shear area lies solely in the grouted keyway. Due to the symmetry of the shear key configuration, the same shear area is utilized in both directions of vehicular traffic. The shear area is highlighted by the dashed line located in the shear keyway in Figure 19. The resultant panel deflection is a result from the left hand panel being exposed to such a shearing load.

***Shear Area of an Angular Corrugated Joint***

With the presence of concrete-on-concrete bearing area for the angular corrugated joint configuration, the effective shear area providing shear resistance is increased. As a vehicular load traverses from one panel to the next, the panels bear on each other and the differential deflection is reduced. Due to the asymmetric nature of the

angular corrugated joint, there are two shear planes present. The shear area engaged in the shear transfer mechanism is dependent on the panel being loaded at a

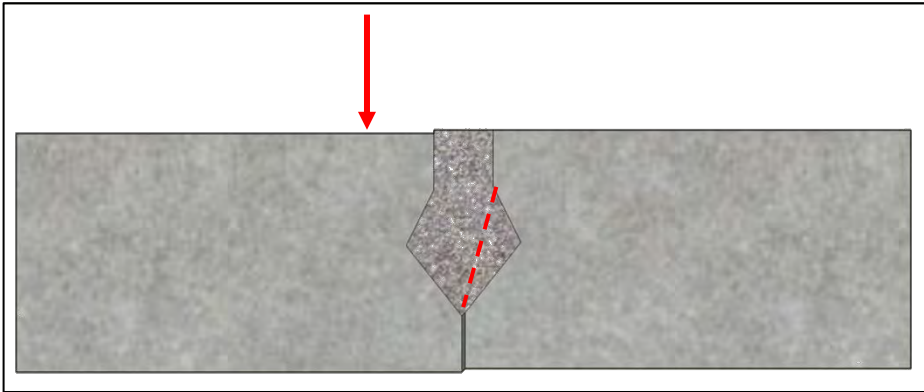

Figure 19: Shear key joint shear area

***Shear area provided by shear key configuration = 4.61 inches***

given time. When the joint is subjected to a vehicular load on the left hand panel, shear area plane 1 is engaged. When the joint is subjected to a vehicular load on the right hand panel, shear area plane 2 is engaged. Figure 20 and 21 depict the resultant panel deflections of the angular corrugated joint configuration. The shear area is highlighted with the dashed line.

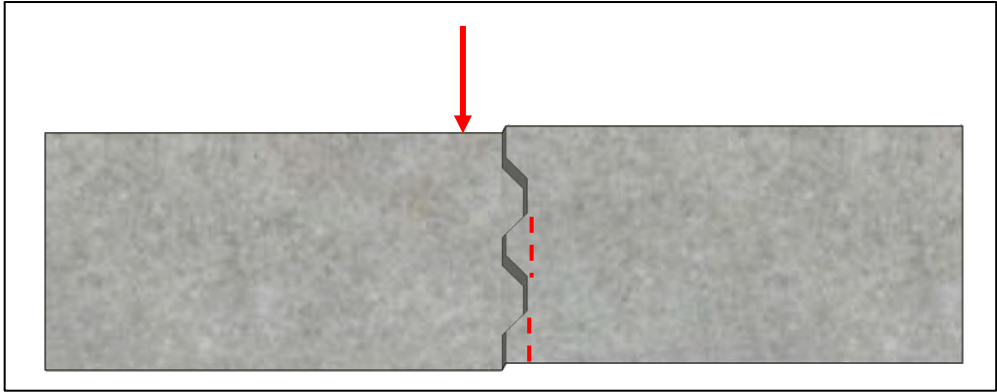

Figure 20: Angular corrugated joint shear area, plane 1

***Shear area provided by angular corrugated configuration = 4.13 inches***

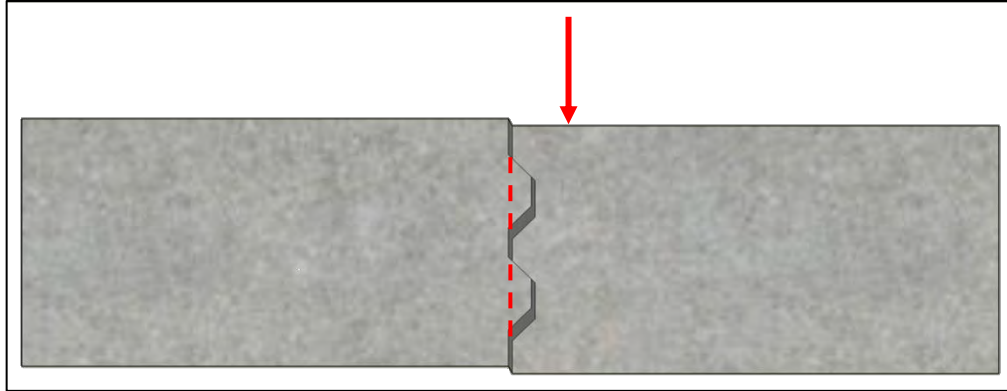

Figure 21: Angular corrugated joint shear area, plane 2

***Shear area provided by angular corrugated configuration = 5.00 inches***

***Shear Area of a Round Corrugated Joint***

With the increased presence of concrete-on-concrete bearing area for the round corrugated joint configuration, the effective shear area providing shear resistance is even greater than that provided by the angular corrugated configuration. As a vehicular load traverses from one panel to the next, the bearing stresses are significantly reduced. Due to the asymmetric nature of the round corrugated joint, there are two shear area planes present. The shear area being engaged in the shear transfer mechanism is dependent on the panel being loaded at the given time. When the joint is subjected to a vehicular load on the left hand panel, shear area plane 1 is engaged. When the joint is subjected to a vehicular load on the right hand panel, shear area plane 2 is engaged. Figure 22 and 23 depict the resultant panel deflections. The shear area is highlighted with the dashed line.

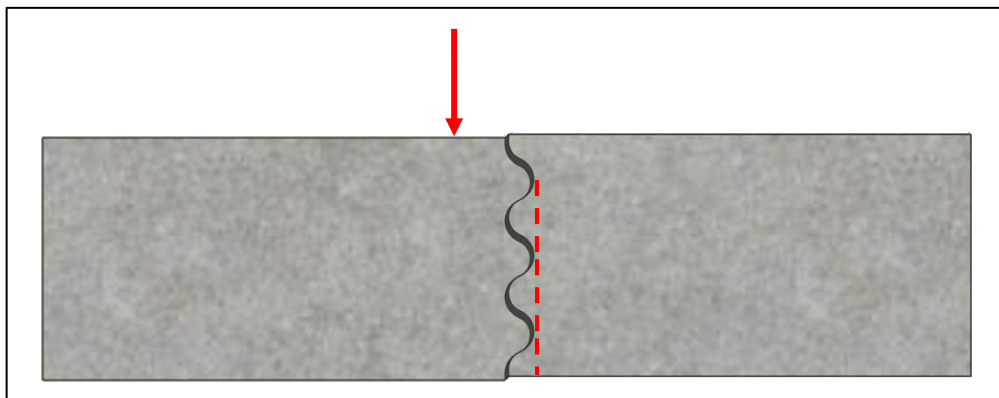

Figure 22: Round corrugated joint shear area, plane 1

***Shear area provided by round corrugated configuration, plane 1 = 6.92 inches***

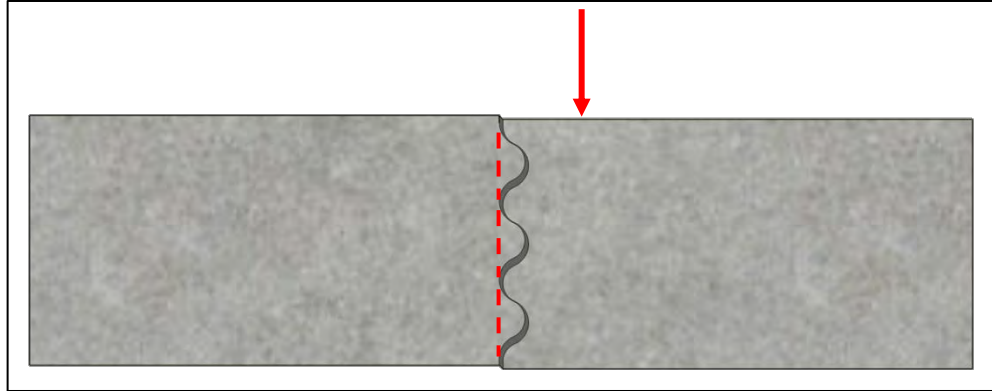

Figure 23: Round corrugated joint shear area, plane 2

***Shear area provided by round corrugated configuration, plane 2 = 5.36 inches***

***Summary of Shear Areas Provided by Transverse Joint Configuration***

Configuration	Shear Area	
	Plane 1 (in.)	Plane 2 (in.)
Butt	0.00	0.00
Shear Key	4.61	4.61
Angular Corrugated	4.13	5.00
Round Corrugated	6.92	5.36

Table 1: Provided shear area summary table

**Test Panel Development and Design**

The design of the test panels is controlled by two requirements. First by the required compressive stresses that need to be induced within the transverse joint, and secondly the desire to only induce shear stresses along the transverse joint and eliminate the possibility of failing the test panels in flexure.

***Test Panel Development Based on Post-Tensioning Requirements***

According to the AASHTO LRFD Bridge Design Manual section 9.7.5.3, a 250 psi minimum compressive stress must be induced into pre-cast concrete bridge deck panels. Additionally, the NHDOT increases this minimum compressive stress requirement by 150 psi to aid in the resistance of negative moment regions over

bridge supports in continuous spans. The total 400 psi compressive stress that must be induced into the bridge deck panels is achieved through the use of two, 1 inch diameter THREADBAR® post-tensioning bars evenly spaced in a 4 foot long deck panel. Figure 24 depicts the post tensioning layout and test panel dimensions.

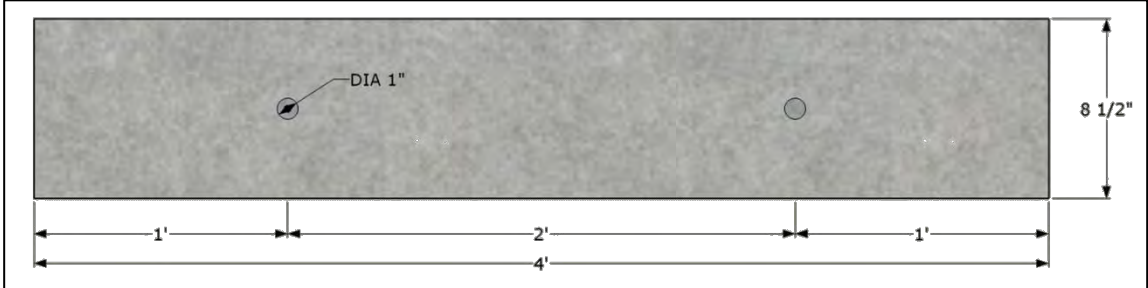

Figure 24: Post tensioning layout in test panels

**Test Panel Development Based on Shear Failure Control**

The desire to only induce shear stresses along the transverse joint limits the width of each panel according to the aspect ratios set forth in the American Concrete Institute’s (ACI) Building Code Requirements for Structural Concrete, ACI 318.

Deep beams are designed and controlled by the shear stresses induced upon them by gravity loads and, therefore, are controlled by shear limits as opposed to flexural design constraints. Deep beams are defined in section 10.7.1 of the ACI 318 code as members loaded on one face and supported on the opposite face so that compression struts can develop between the loads and supports (ACI 318-05, 2005). Following section 10.7.1(a), the resulting panel dimensions are summarized in Table 2.

	Specimen 1 in.	Specimen 2 in.	Assembled Specimen in.
Depth	8.50	8.50	8.50
Width	16.00	16.00	32.00
Length	48.00	48.00	48.00

Table 2: Test specimen dimensions

**TEST SPECIMEN MATERIALS, FABRICATION AND ASSEMBLY**

**Specimen Materials**

The materials used in this research are vital to the overall performance of the proposed bridge deck replacement system. Test specimen materials must be representative of the materials specified for real-world application in order to maintain appropriate scalability and obtain accurate test results for use in specification.

**Concrete**

The concrete specified for use in the test specimens is a self consolidating concrete (SCC). SCC is commonly used in pre-cast concrete applications due to its ease of placement and consolidation of the mix, which occurs during the concrete placement. The SCC needed a high early strength to allow for rapid form removal and panel handling and storage. A low permeability is vital for bridge deck panels to reduce the impacts of water and chloride infiltration. A high flowability is also desired to allow for consolidation around the congested deck panel post-tensioning ductwork and handling reinforcement. The mix design for the SCC can be found in Appendix B. Table 3 summarizes the requested SCC mix properties.

<b>SCC Material Specifications</b>				
<b>Aggregate</b>	<b>Air</b>		<b>28 Day</b>	
<b>Size</b>	<b>Content</b>	<b>Spread</b>	<b>Strength</b>	<b>Permeability</b>
3/8"	6.0%	26 inches	5000 psi	3000 coulombs

Table 3: SCC material specifications

The delivered concrete varied slightly from the specified mix requirements but was deemed acceptable for casting the test panels. The fresh concrete was subjected to a spread test as well as an air content test. The air content test was performed in accordance with ASTM C231-04. The spread and air content values are listed in Table 4.

<b>Air</b>	
<b>Content</b>	<b>Spread</b>
3.0%	23.5 inches

Table 4: Deviated SCC material properties

Twenty-three cylinders were cast in compliance with ASTM C192/C192M-02 in order to test the material properties of the hardened concrete. The compressive strength of the SCC was tested in compliance with ASTM C39/C39M using the Forney hydraulic testing machine located in the civil teaching lab at UNH. The compressive strength of the test cylinders has been included in Appendix B. The ultimate compressive strength was determined to be 8,584 psi. To determine the tensile capacity of the hardened concrete, a cylinder was subjected to the ASTM C496-96 standard test method for splitting tensile strength. The resulting tensile capacity was determined to be 603 psi.

Three methods were used to determine the elastic modulus of the SCC. Two of the methods utilize empirical equations designated in ACI-318. These empirical equations have been accepted in determining the elastic modulus for normal weight, normally consolidated concrete. However, with the use of SCC in the test panels, an experimental method of determining the elastic modulus was deemed necessary to

compare the empirically determined values. To accomplish this, one of the concrete cylinders was subjected to the ASTM 469 standard test method for determining the elastic modulus of the hardened SCC. Table 5 lists the resulting values for each method. As can be seen, the experimentally determined elastic modulus is much less than the empirically derived values.

Method	Elastic Modulus ksi
ACI-318 8.5, 1	5,394
ACI-318 8.5, 2	5,281
ASTM C-469	4,265

Table 5: Elastic modulus values for SCC

The hardened SCC was also subjected to a permeability test to verify the permeability of the mix. The NHDOT conducted the permeability test and determined that the permeability of the hardened SCC was 3,646 coulombs.

***Carbon Fiber Reinforced Polymer (CFRP) Reinforcing Grid***

The reinforcement used for the deck panel handling is a carbon fiber based reinforcing grid. This CFRP reinforcing grid is the same NEFMAC CFRP reinforcement utilized in the Rollins Road Bridge deck located in Rollinsford, NH.

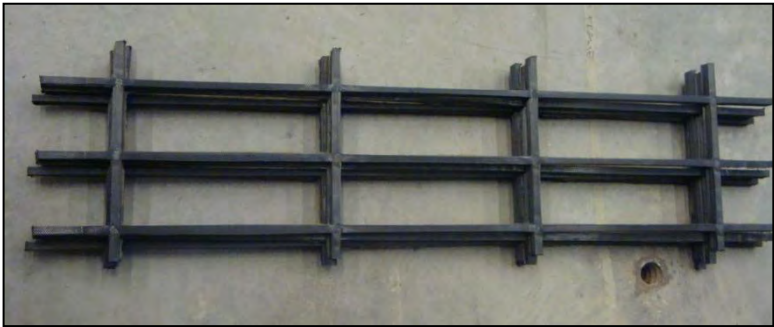

Figure 25: CFRP reinforcing grid

Each NEFMAC grid, depicted in Figure 25, is 12 inches wide and 44 inches long and was placed 2 inches up from the bottom of the test panels to provide the 2 inch minimum cover on all sides of the panels. The bar spacing in the grid pattern is 3.50 inches x 11.50 inches on center. Each grid element is ½ inch x ½ inch square. The NEFMAC has a tensile strength,  $f_{tu}$  of 190 ksi and an elastic modulus,  $E_f$  of 10,400 ksi (Schmeckpeper, 1992).

## **Transverse Joint Material**

The transverse joint material utilized in the test panels is dependent on the transverse joint configuration. The shear key joint configuration utilized a cement based grout material while the remaining configurations utilized the SBA.

### ***Segmental Bridge Adhesive***

A segmental bridge adhesive (SBA) was used within the transverse joint of abutting deck panels for the butt, angular, and round corrugated joint configurations. The SBA used is a proprietary product developed by the Sika Corporation, Inc. and is known as Sikadur® 31, SBA. Sikadur® 31 is a high-modulus two-component, moisture-tolerant, solvent free, epoxy resin system (Sika Corporation, 2008). Sikadur® 31 is a unique structural adhesive used for bonding hardened concrete to hardened concrete. It has been specifically designed for use in segmental bridge construction. The Sika Corporation recommends that Sikadur® 31 be used for the structural bonding of post-tensioned pre-cast concrete bridge deck segments, sealing joints between concrete segments and segment-by-segment erection procedures (Sika Corporation, 2008). The material is supplied in three temperature ranges to provide for nearly year-round application in the northeast.

### ***Shear Key Filler Material***

The shear key joint configuration utilizes grout material in the void space formed by adjacent deck panels. This void space is filled with a proprietary grouting material manufactured by the same Sika Corporation that provided the SBA used in the other joint configurations. SikaGrout® 212 is a high performance, cement-based grout. It contains a special blend of shrinkage-reducing and plasticizing/water-reducing agents that compensate for shrinkage in both the plastic and hardened state (Sika Corporation, 2003).

## **Post-Tensioning Equipment**

The post-tensioning system used in this research is a proprietary system developed in 1965 by Dywidag Systems International, Inc. (DSI) known as THREADBAR®. The THREADBAR® system utilizes hot-rolled and proof-stressed alloy steel conforming to ASTM A722 CAN/CSA standards (Dywidag Systems International, 2006). The steel bars have a continuous rolled-in pattern of thread-like deformations along their entire length and allow anchorages and couplers to be threaded on at any point (Dywidag Systems International, 2006).

The THREADBAR® components utilized in this research project are:

- 1 inch diameter x 60 inch, 150 ksi, hot rolled, threaded steel bars
- 5 inch x 5 inch x 1-1/4 inch bearing plates



- Semi-hemispherical, self-centering nuts
- 1-7/8 inch diameter, galvanized post tensioning ducts
- Plastic grout ports, tubes and tube caps

Figure 26 depicts the major components of the THREADBAR® system.

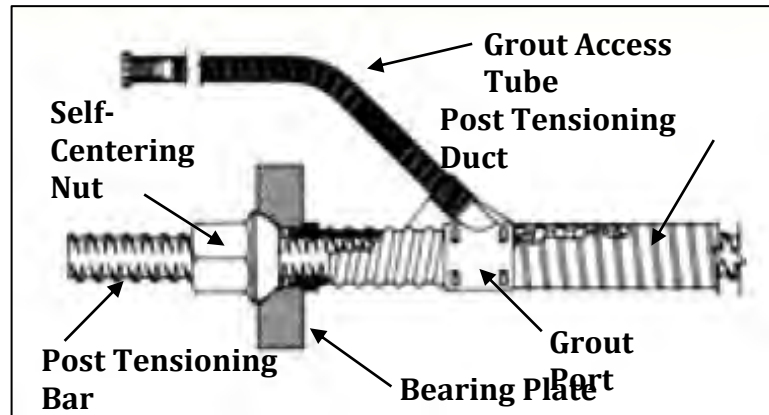

Figure 26: DSI's THREADBAR® forming components

### Specimen Formwork

The specimens used in this research were fabricated in the Structures High Bay in Kingsbury Hall at UNH during the fall of 2008. Fabrication materials were selected and used based on their expected performance, availability, cost and familiarity to the fabricators.



Figure 27: Typical test specimen formwork

The construction of the test specimens used in this research strived to achieve the same level of precision and quality expected from a pre-cast concrete fabricator where full scale bridge deck panels are typically fabricated. The formwork constructed provided the most efficient means of mass producing a large number of test specimens while maintaining performance requirements. Figure 27 depicts the typical formwork created to fabricate the test specimens.

The formwork for each specimen contained the same three basic elements, form bodies, form side rails and post-tensioning formwork. The form bodies and post tensioning formwork were identical for all four joint configurations. The form side rails were the only formwork elements that differed from configuration to configuration.

### ***Form bodies***

A form body is shown in Figure 28. A form body is comprised of five elements, a base, runners, spines, specimen dividers and end caps. Each form body element is constructed of  $\frac{3}{4}$  inch marine grade, birch plywood.

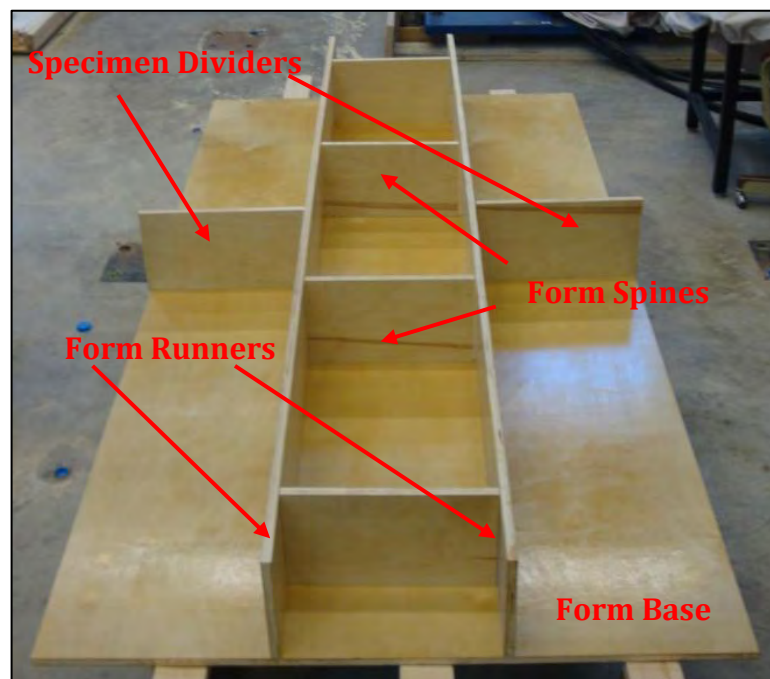

Figure 28: Typical test specimen form body

The form base is comprised of one 48 inch x 96 inch sheet of plywood. The form base had two coats of polyurethane applied to improve the surface finish of the test specimens as well as aid in specimen removal from the forms.

Two form runners were present in each form body. The form runners created the rear vertical faces for the test specimens. The form runners were 8.50 inch x 96 inch elements with two coats of polyurethane applied to the exterior faces.

Four form spines separated the two form runners. The form spines were located at 16, 32, 64 and 80 inches along the length of the form base. The spines provided additional stiffness to the form bodies to ensure the rear vertical faces of the test specimens remained vertical during casting. The form spines were 8.50 inches tall and varied in length depending upon which edge configuration they accompanied.

The specimen dividers were 8.50 inch x 16 inch elements and created two 48 inch x 16 inch bays along each side of a form body. Two coats of polyurethane were applied to both faces of the specimen dividers.

The end caps were 9.25 inch x 49.5 inch elements that sealed the ends of each form body.

All elements of the form bodies were connected by #6, 2.50 inch drywall screws. Form runners were screwed from the bottom side of the form base 8 inches on center. All screw holes were pre-drilled to eliminate the possibility of splitting and aid in element alignment. The interior edges of the form bodies were then sealed with silicone caulking to ensure no loss of concrete would occur through the formwork seams.

### ***Form Side Rails***

The form side rails varied in fabrication based upon which joint configuration they formed. There were however, many similarities in their overall design. Each side rail contained a side rail backer board, a 9.25 inch x 96 inch element, as well as an 8.50 inch x 96 inch form board element. The rail backer and form boards were constructed from the same  $\frac{3}{4}$  inch marine grade birch plywood that was utilized in the form bodies. The varying geometric configurations were then fabricated upon the form board.

### ***Butt Joint Side Rail***

The butt joint side rails were the least complex side rails to fabricate. The side rails were comprised of only a side rail backer board and a form board described above.

### ***Shear Key Side Rail***

The shear key side rail contained the side rail backer board as well as the form board. In order to form the keyway in which the grout filler material can transfer shear between adjacent panels, a void must be created in the concrete. This was accomplished in the shear key through the use of large chamfer strips created from the  $\frac{3}{4}$  inch marine grade birch plywood as well as  $\frac{1}{4}$  inch luan plywood to create 1 inch and 2 inch nominal dimensions for the large chamfer strips. Figure 29 shows a completed shear key form side rail.



Figure 29: Shear key form side rail

### ***Angular Corrugated Form Side Rail***

The angular corrugated form side rails were fabricated solely from  $\frac{3}{4}$  inch marine grade beech plywood elements. These elements include the form side rail backer board and form board present in all side rail forms, as well as chamfer strips that created the protrusions and undulations present in the angular corrugated



Figure 30: Angular corrugated to form

configuration. Two coats of polyurethane were applied to the side rail to aid in release and improve panel surface finish. Figure 30 shows a form side rail for a tongue corrugation.

### ***Round Corrugated Form Side Rail***

The round corrugated form side rail is the most complex side rail to fabricate. It utilizes the side rail backer board and form board to support the actual form that creates the sinusoidal joint configuration. In order to create the sinusoidal shape, a rubber form was fabricated in the lab at UNH.

The rubber form has to be created in multiple steps. First, a rubber form trough was fabricated to create the rubber side rails. The form trough was created by building a 2 inch deep box around a 40 inch x 96 inch sheet of 2.67 inch x 7/8 inch Phase-2 PVC corrugated panel. The corrugated panel is a proprietary extruded sheet provided by the H&F Manufacturing Corp. The 2.67 inch x 7/8 inch Phase-2 panel is a sinusoidal corrugated sheet extruded from PVC. The sinusoidal shape has a 2.67 inch wavelength and a 7/8 inch amplitude. Next, the troughs were created by separating the Phase-2 panel into different segments creating a tongue and groove panel form. To attach the rubber form to the rail backer and form board, 1/4 inch x 6 inch carriage bolts were cast into the rubber. Figure 31 shows the form trough.



Figure 31: Round corrugated rubber form trough

The rubber was then prepared to fill the bays created in the rubber form trough. The rubber used was a proprietary product of the Polytek Development Corporation called Poly 75-65 RTV Liquid Rubber. Poly 75 is a two-part polyurethane rubber that is commonly used in ornamental pre-cast concrete applications. Equal parts of component A and B were weighed and mechanically mixed together. The rubber was then poured into the rubber form trough bays and allowed to cure. A curing tent was installed over the rubber form trough and space heaters were used to raise the tent temperature to 77° F. The rubber molds were allowed to cure for



approximately 96 hours before they were removed from the rubber form trough. Figure 32 depicts the rubber form trough in the curing tent.

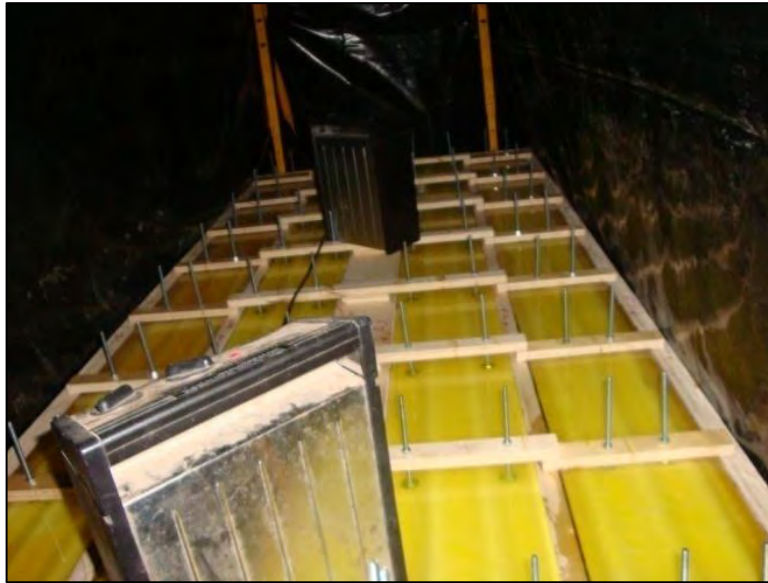

Figure 32: Curing tent for rubber form trough

Once the rubber form rails were removed from the rubber form trough, they were attached to the side rail backers and form boards by the hardware cast into the rubber forms. Figure 33 shows a completed round corrugated form side rail.

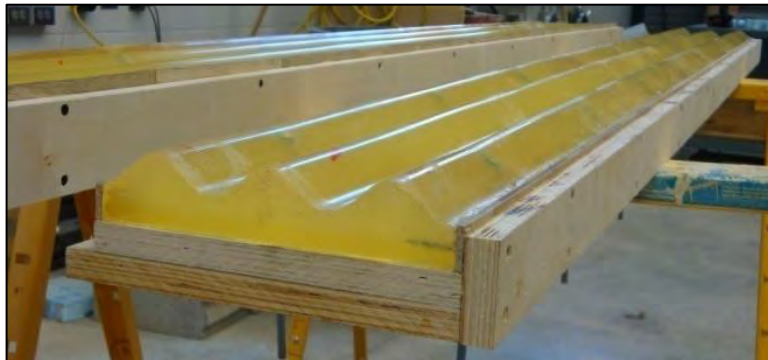

Figure 33: Round corrugated form side rail

### ***Post-Tensioning Formwork***

The post-tensioning formwork provides the necessary voids and access points in the panels to allow for the post tensioning bars to penetrate the panels. All of the post-tensioning formwork is a proprietary system of the DSI Corp. and is specified based on the post-tensioning bar diameter.

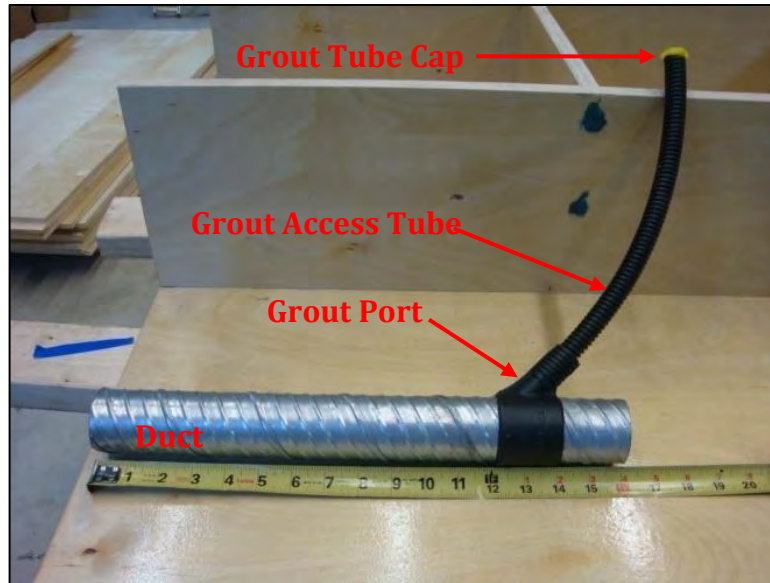

Figure 34: THREADBAR® formwork

### ***Post-Tensioning Ducts***

The post-tensioning ducts are comprised of 1-7/8 inch diameter corrugated galvanized metal tubing. The total duct length, including the grout access port is 16 inches.

### ***Grout Access Ports and Tubes***

The grout access ports allow for the injection of grout material into the ductwork to aid in the protection of the post-tensioning bars from corrosive material. The grout access ports are plastic sleeves that fit inside the galvanized post-tensioning ductwork. Attached to the grout access ports are the grout access tubes. These tubes provide access to the embedded ducts. To protect the access tubes from being clogged with concrete during panel casting, tube caps are threaded into the open ends of the tubes.

Once the ducts and access ports were assembled, a heat shrink tape was wrapped around the grout access port. This was done to ensure a tight seal so no concrete could infiltrate the assembled ductwork during casting.

To attach the post-tensioning ducts to the form bodies and form side rails, rigid polystyrene foam plugs were cored to fit inside the diameter of the ductwork. The plugs were then attached to the form bodies and form side rails with carriage bolts. The duct assemblies were then slid onto the plugs located on the form bodies while the form side rails were aligned and slid into place. Once aligned, the form side rails were then secured to the form bodies with 2.5 inch, #6 drywall screws 8 inches center-to-center spacing.

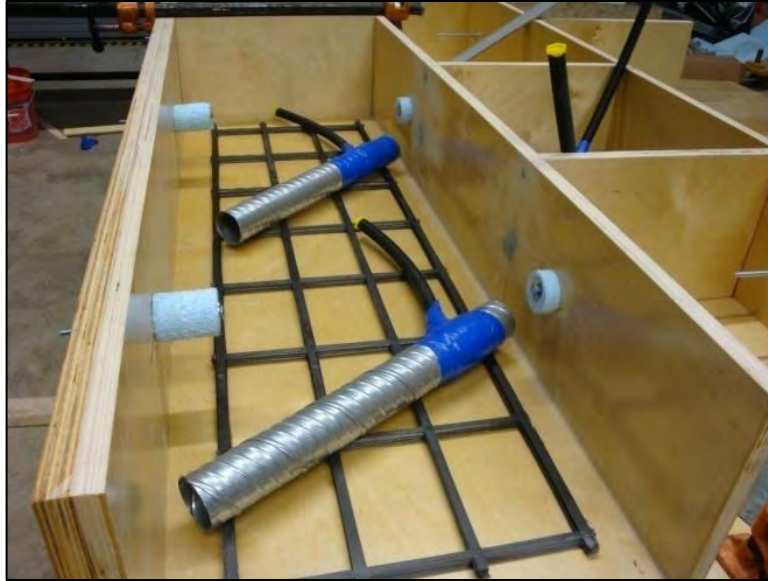

Figure 35: Complete panel formwork

### **Test Specimen Assembly**

The general assembly procedure was similar for all of the joint configuration types. Treatment of the transverse joint differs between the shear key and the other configurations in the extra steps required to prepare the shear key for placement of the key grout.

#### ***Panel Alignment and Post-Tensioning Equipment Installation***

Two individual panels are brought into location next to each other approximately 6 inches apart. A post-tensioning bar was then passed through the post-tensioning ductwork of the first panel and continued into the mirrored duct of the abutting panel. A bearing plate and nut were installed on the opposite ends of the bar protruding out of the panels.

#### ***Transverse Joint Preparation***

With the post-tensioning equipment installed, the transverse joint was ready for assembly. The transverse joint assembly was a multi step process for each configuration.

#### ***Butt, Angular and Round Configurations***

The SBA was used in the transverse joint in the butt, angular, and round configurations. Prior to applying the SBA, the test panels and SBA were pre-conditioned following the procedures outlined in the technical data sheet provided by DSI. The test panels were then cleared of any dirt, grease, oil, and form release products. The panels' surfaces should be roughened with a wire brush or similar



mechanical method. It was highly recommended that the concrete be a minimum of three to four weeks old. Next, condition both parts A and B of the SBA to the appropriate temperature for the application temperature range to yield an appropriate pot life. Once conditioned, thoroughly mix part A and B separately to ensure a uniform consistency of each product. Mix two parts A with one part B by weight and mechanically mix until a uniform color consistency is achieved.

The SBA should be applied to each face that will be adhered together. This is best achieved with a gloved hand. A 3/16 inch thick layer of SBA is recommended on each face. Bring the panels into contact with each other within the SBA's pot life. Squeeze the panels together via the post tensioning bar bearing plate and nut assemblies to expel excess SBA from the joint. Ensure the self-centering nuts are snug tight.



Figure 36: SBA application

### ***Shear Key Configuration***

The shear key transverse joint was filled with a cementitious grout instead of the SBA. The test panels and key grout were conditioned according to DSI recommendations in the technical data sheets for the SikaGrout® 212 material. The test panels were cleared of any dirt, grease, oil or form release products and the key surfaces were roughened with a wire brush or similar mechanical method.

A spray adhesive was applied to the bottom edge of each abutting panel. The backer rod material was then applied to the adhered surfaces. The backer rod material was ½ inch diameter foam 48 inches in length. The panels were then squeezed closer together via the post-tensioning bearing plate and nut assembly until the backer rod material was compressed to about half of its original diameter. To form the ends of the shear keys, epoxy putty was applied to the ends of each panel along the edge of the shear key. An 8 inch x 10 inch section of plexi-glass was compressed

into the epoxy putty to seal the ends of the test panels. The shear key was then formed, as seen in Figure 37, and ready to receive the grouting material.

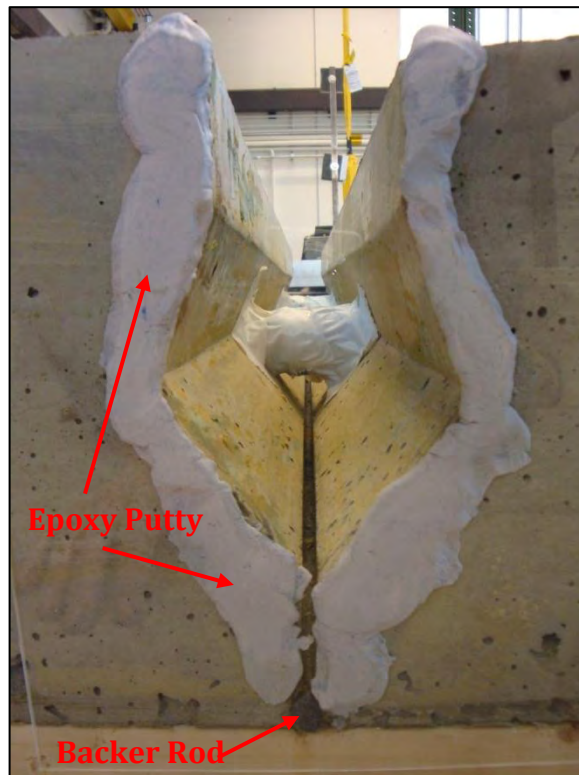

Figure 37: Shear key formed by adjoining panels

The key grout was then ready to be mixed and placed. The appropriate amount of water was added to achieve the desired consistency of the grout material. The grout and water was thoroughly mixed by hand until a uniform consistency was achieved. The freshly mixed grout was then placed within 15 minutes of adding the water. Once the grout achieved final set, the plexi-glass and epoxy putty were removed.

### ***Stress Post-Tensioning Bars***

Once the transverse joint material was cured, the post-tensioning bars could then be stressed. As described in section 3.3.1 (Robert, 2009), a total of 400 psi must be achieved in the deck elements. This was achieved by the transfer of stress developed in the post-tensioning bars during the post tensioning procedures into the deck panels. A total load of 81.6 kips was induced into the post-tensioning bar to achieve the required stress levels in the deck panels.

The stressing apparatus utilized by the THREADBAR® post-tensioning system is shown in Figure 38. The stressing apparatus was comprised of the hydraulic pump, remote pendant switch, hydraulic pressure valves, pressure gauge, hydraulic fluid lines, stressing jack and ratchet handle, pull rod and pull rod coupler and jack nut.



Figure 38: DSI's post tensioning stressing equipment

After connecting the stressing jack to the hydraulic pump via the hydraulic fluid lines, the system was then bled for proper operation. The stressing piston of the jack was extended  $\frac{1}{2}$  inch outward. The pull rod and pull rod coupler were then thread onto the end of the bar to be stressed. The jack was then slid onto the pull rod until the socket end of the jack engaged the self centering nut. The jack nut was then thread onto the end of the pull rod coupler until it engaged the extended stressing jack piston. The pump valves were then placed in the appropriate positions for stressing.

After verifying that all stressing equipment had been accurately installed, the jack calibration sheet was used to locate the required pressure gauge reading for the desired bar load. To achieve the desired 81.6 kips in the post tensioning bar, a pressure gauge reading of 3,950 psi was required. Using the remote pendant switch, the bar was stressed until the appropriate pressure reading was achieved. Tightening of the self-centering nut was performed during the stressing operation using the ratchet handle located on the jack. Once the desired stress level had been achieved, the pump valves were switched to the appropriate locations to release the system pressure. The jack piston was backed into its fully retracted position and the jack anchor was removed. The jack was then slid off of the pull rod and the pull rod and pull rod coupler were un-threaded from the stressed bar.

# TESTING

## Development of Applied Loading

The test panels were subjected to the service loadings, that they would be required to resist, if used as bridge deck panels. The design service load is specified by the AASHTO Standard Specification for Highway Bridges, 17<sup>th</sup> Edition - 2002. In accordance with section 3.6.1.2, minimum loading, an HS-20 vehicle load was specified for the design of bridge decking. Therefore, the test specimens were also subjected to the same HS-20 vehicle loading.

Section 3.6.1.2 defines an HS-20 vehicular load as a tractor trailer truck with a gross weight of 36 tons. A maximum axle load for the HS-20 vehicle is 16 tons. To determine a wheel load, the axle load was halved, 8 tons or 16 kips.

## *Applied Loading Schedule*

Table 6 describes the applied loading schedule for testing each joint configuration. The 16 kip service load, which is half of the axle load used by AASHTO (representing the load of a single wheel), was cyclically applied, with each multiple of the service load applied twice. The 25 kip Tandem Load, as described in section 3.6.1.2.3 (AASHTO, 2002), would not have provided as many increments of increased loading as desired prior to ultimate failure, thus the 16 kip wheel load was used.

Cycle #	Load kips	
1	0 - 16	
2	0 - 16	Service
3	0 - 32	
4	0 - 32	2 x Service
5	0 - 48	
6	0 - 48	3 x Service
7	0 - 64	
8	0 - 64	4 x Service
9	0 - 80	
10	0 - 80	5 x Service
11	0 - 96	
12	0 - 96	6 x Service
13	0 - 112	
14	0 - 112	7 x Service
15	0 - 128	
16	0 - 128	8 x Service
17	0 - Ult.	Ult.

Table 6: Applied loading schedule

### ***Ultimate Applied Load***

The ultimate load applied to a test specimen was defined as the loading at which the panel has been deemed failed. Failure of a test panel was defined as the point at which the panel will no longer take increased loadings, significant cracking has occurred, or the test specimen has completely separated into at least two pieces. If the panel has failed prior to achieving a full load cycle, testing for that assembly was complete.

### **Specimen Test Protocol**

For each transverse joint configuration, two specimens were tested. For the first set of specimens, each configuration was tested fully post-tensioned to determine the configuration's ultimate capacities as well as their ability to transfer shear. The failure modes for each assembly were observed and noted.

The second set of specimens tested each joint configuration without post-tensioning. The post-tensioning bars were removed, and the panels were then loaded. The configuration capacities and failure modes were observed and noted.

### **Testing Apparatus**

The general shear test layout is derived from the provisions set forth in ACI 318 that induce shear stresses within deep beams. Section 10.7.1(b) locates the applied load on the deck panel test assembly so that the desired shear stresses are developed without the possibility of flexural failure. The test setup is depicted in Figure 39.

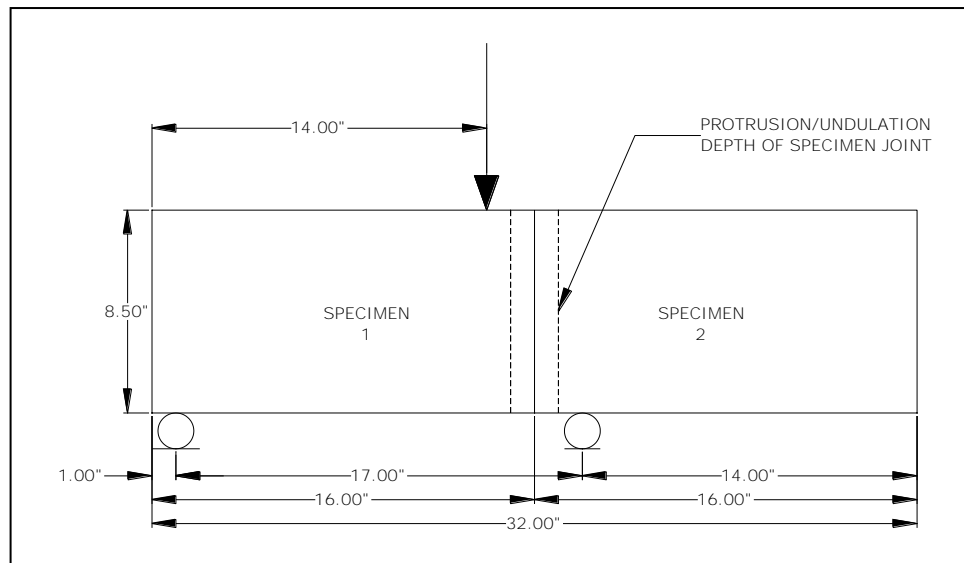

Figure 39: Shear test layout

The testing apparatus used to replicate the shear test for this research is comprised of the multiple components described in the following sections.

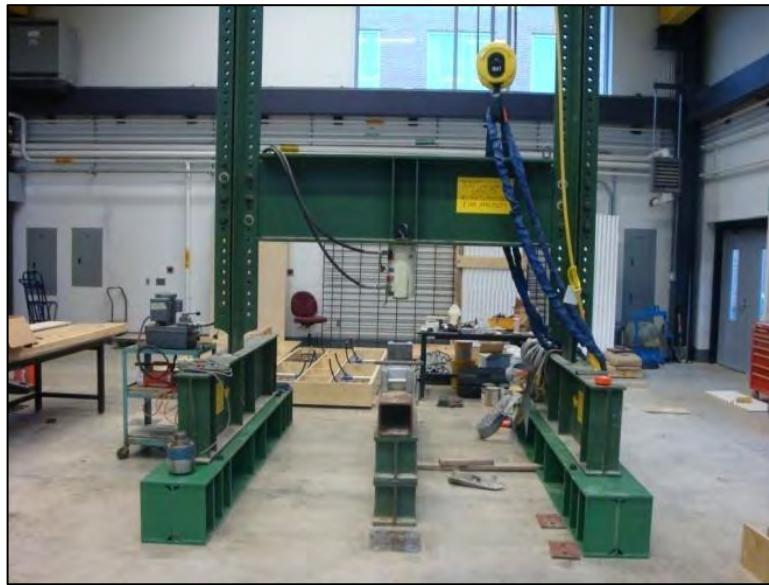

Figure 40: Loading frame

### ***Loading Frame***

The loading frame, depicted in Figure 40, utilized in this research project was the same loading frame utilized in the bridge deck replacement system feasibility study. The load frame was comprised of two supporting legs made of multiple, stiffened wide flange sections. The two legs were connected by a header beam, also comprised of a wide flange section with web stiffeners.



## ***Hydraulic Pump***



Figure 41: Hydraulic pump

The hydraulic pump used to operate the hydraulic loading piston was an Enerpac ZE-3 Series pump with a manual control valve. In-line pressure gauges were used to monitor the system pressure for the feed and return lines. The hydraulic pump and accessories have a 10,000 psi maximum working pressure rating. The pump is powered by a 1.00 horsepower electric motor, seen in Figure 41.

## **Hydraulic Loading Piston**



Figure 42: Hydraulic loading piston

The loads applied to the test specimens were achieved with the hydraulic loading piston attached to the header beam of the load frame, seen in Figure 42. The piston is a double acting hydraulic cylinder manufactured by Ram-Pac International, Inc. The cylinder model is the RC-150-DA-6 and has a 150 ton loading capacity, a 6 inch stroke and a 4.50 inch rod diameter (Ram-Pac International, Inc., 2003). At capacity, the working pressure is approximately 7,800 psi.

### **Load Application Components**

To transfer the load from the hydraulic piston to the test panels, multiple components were utilized. The hydraulic piston transferred the load through the load cell, onto the circular seat and finally to the loading block. A neoprene rubber pad was placed between the loading block and the surface of the test panels to help distribute a uniform load over the rough concrete surface of the deck panels.

The load cell was placed within a bag to prevent it from being damaged during loading if the panels were to fail into two separate halves. The load cell is described in detail in the following paragraphs.

The circular seat is a 6 inch diameter, steel plate. The plate is comprised of a concave based and convex top half. These two separate halves work in unison to ensure a vertical load application.



The loading block is a 10 inch x 10 inch x 2 inch steel plate. The loading block transfers the vertical load from the hydraulic piston to the face of the transverse joint. The load application apparatus is shown in Figure 43.

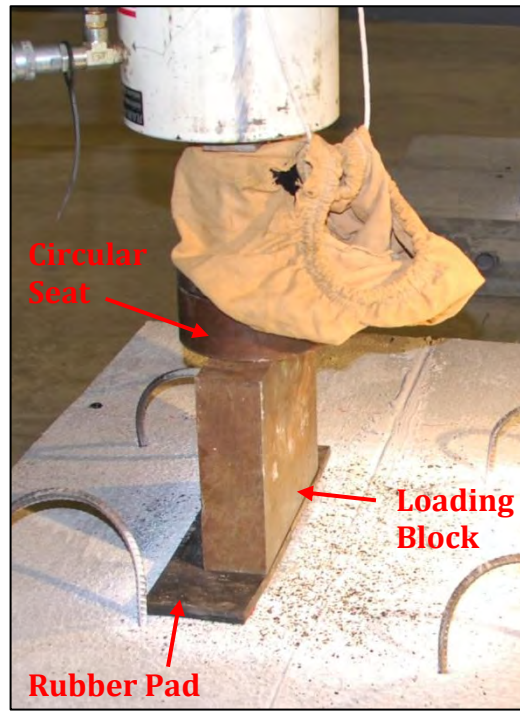

Figure 43: Load application components

### ***Specimen Supports***

The support mechanisms utilized to test the panels were comprised of two roller assemblies. Each roller assembly was made of a 2 inch diameter rod welded to a 1 inch x 4 inch plate. The roller assemblies were then welded to support legs that are rolled W sections with web stiffeners located throughout their length. The individual roller assemblies were then welded together to create a rigid support mechanism. The specimen supports are shown in Figure 44.



Figure 44: Roller support

### **Data Acquisition**

Applied load and specimen deflection values needed to be collected continuously throughout the testing procedure. Data acquisition was achieved with two separate systems during testing. In order to collect applied load values, a load cell was utilized. To collect specimen deflection values, a digital image correlation system was utilized.

#### ***Applied Load Data Acquisition***

To quantify and record the loads applied to the test specimens, the applied loads are transferred from the loading piston through a load cell and to the loading points on the test specimens. The load cell utilized was manufactured by Transducer Techniques, Inc. The load cell was the CLC-300K series. It is fully bridged and has a 300 kip working capacity. The load cell requires a 10 Volt DC excitation voltage and provides a 2 mV/V rated output (Transducer Techniques, 2009). Figure 45 depicts the load cell utilized during testing.

The load cell was connected to a National Instruments SCXI-1001 chassis. The SCXI-1001 chassis supplies power to and contains control circuitry for the SCXI series modules used in concert with the load cell (National Instruments, 2005). The modules used in concert with the load cell are the SCXI-1314T and the SCXI-1520. The load cell utilizes a 9-pin “D” series connector that provides a Transducer Electronic Data Sheet (TEDS) (Transducer Techniques, 2009). The “D” series connector was then plugged into the SCXI-1314T module via an RJ-50 10-pin/10-conductor modular plug. The SCXI-1314T is a universal full or half bridge terminal block used for connection to hardware with TEDS smart sensors (National Instruments, 2005). The SCXI-1314T was then



Figure 45: Load cell

connected to the SCXI-1520 module. The SCXI-1520 module is an eight-channel module for interfacing to Wheatstone-bridge based sensors, such as the CLC series fully bridged load cell utilized in this research (National Instruments, 2005). The National Instruments chassis and accessory modules used to interface with the load cell comprise the data acquisition (DAQ) system utilized to collect the voltage outputted by the load cell. Once the load cell was successfully connected to the DAQ, the voltage excitations were converted from voltage outputs to actual load values. This was done through the use of LabView 8.5. LabView 8.5 is a software program that translates the outputted voltages into their corresponding loads. Figure 46 depicts the DAQ system and corresponding load output reading as converted by LabView from the load cell.

### ***Specimen Deflection Data Acquisition***

The deflection of each panel in the test specimens were recorded as the loads were applied. Dial gauges have typically been used in past research phases of this project. While the values provided by the dial gauges are very accurate, data collecting was fairly labor intensive due to the number of dial gauges needed and the number of readings required for each gauge. Also, with the close proximity of the load to the joint face, a dial gauge does not easily fit in the space provided. As the applied loads climb in magnitude, it is increasingly unsafe to approach the loading piston in

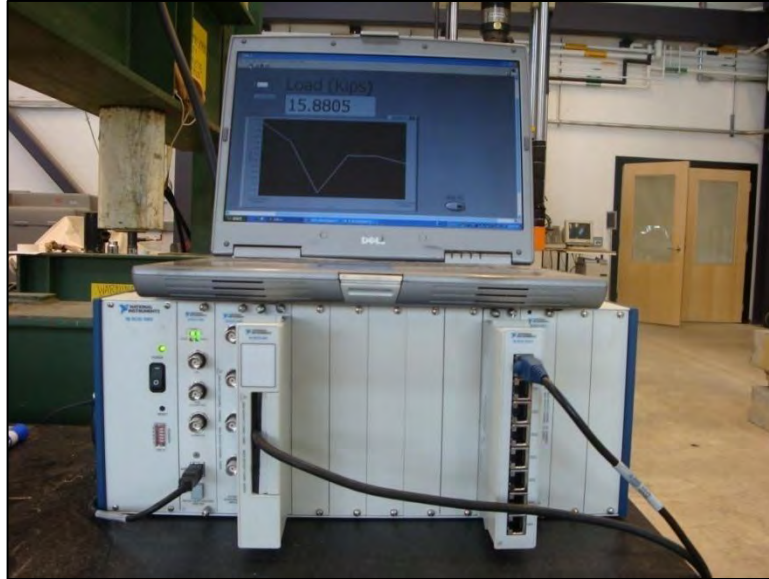

Figure 46: Applied load data acquisition and computer

order to obtain a dial gauge recording. Finally, if and when ultimate failure of the test specimens occur, damage may be done to dial gauges as the panels break away from their supports resulting in increased costs of replacing dial gauges for each test. Therefore, a new method of recording deflection values needed to be investigated and utilized for this research. Linear varying differential transformers (LVDT's) were considered for replacement of the dial gauges. The LVDT's would have been hooked into the DAQ, eliminating the need for manually recording deflection values, but, like dial gauges, the LVDT's require direct contact with the panels. Similar to the dial gauges, the LVDT's are susceptible to permanent damage during ultimate failure of the test specimens.

The need for non-contact deflection measurement techniques was required for this testing. The solution to this non-contact measurement system is digital image correlation technologies. Digital image correlation (DIC) refers to an optical method of measuring the displacement of pixels throughout a series of digital images. The use of Correlated Solutions, Inc. dual-camera DIC system provided the non-contact deflection measurements obtained in this research. The dual-camera system captures a series of digital images throughout testing and compares the images to the reference image to deduct the deflection measurements for the test specimens.

Prior to testing the panels, the surface of the test specimens must be prepared with a speckle pattern in order for the DIC system to compare the pixel movement of the images throughout testing. Figure 47 depicts a test specimen with the required speckle pattern applied. This speckle pattern was created by spattering spray paint onto the panels.



Figure 47: Typical speckle pattern applied for use with DIC system

With the dual-camera system setup, as seen in Figure 48, and calibrated, image capturing may begin. An initial image is taken and set as the reference image. This reference image depicts the test setup with no load applied. As testing progresses, images are captured at each desired loading. When testing was completed, the DIC is conducted using Vic3D software. The images are compared to the reference image and the displacements are calculated and exported into an Excel file format for further manipulation.

## RESULTS

### Ultimate Capacity

The ultimate capacity of each transverse joint configuration is summarized in Table 7.

Configuartion	Ultimate Capacity (kips)	
	Post-Tensioned	Non-Tensioned
<b>Butt</b>	111.6	101.0
<b>Shear Key</b>	96.1	30.2
<b>Angular Corrugated</b>	127.8	56.5
<b>Round Corrugated</b>	140.5	77.9

Table 7: Ultimate capacity

At first glance, the results for the non-tensioned ultimate capacities are not what would have been expected in regards to the substantially larger ultimate capacity of the butt joint configuration. After a thorough investigation of the failed test panels, it was determined that the location of the NEFMAC reinforcing grid played a fairly significant role in the increased capacity of the butt joint over the other configurations.

For all of the varying joint configurations, the NEFMAC reinforcing grids were originally located within the deck panel formwork so as to provide the required 2 inch minimum cover from the exterior edges of the panels. In some instances, during concrete placement, the NEFMAC reinforcing grids were dislodged from their installed locations, resulting in varying cover thickness from the sides of the deck panels. This relocation of the reinforcing grids did not become apparent until after the non-tensioned deck panels were tested and the failure modes evaluated. During the visual inspection of the failed test panels, the exposed NEFMAC reinforcing grid locations were noted, and the results are listed in Table 8.

<b>Configuration</b>	<b>NEFMAC Location (in.)</b>
<b>Butt</b>	0.875
<b>Shear Key</b>	-
<b>Angular Corrugated</b>	3.625
<b>Round Corrugated</b>	4.750

Table 8: NEFMAC grid distance from transverse joint face

During casting, in both the angular and round corrugated joint configurations, the reinforcing grids had been pushed away from the transverse joint face towards the rear exterior edge of the deck panels. The butt joint configuration reinforcing grids were subjected to the exact opposite scenario, they were displaced during casting towards the transverse joint face.

With the lack of concrete-on-concrete bearing in the butt joint that is present in the corrugated configurations, the increased ultimate capacity for the butt joint is counterintuitive to what the trend would have been for predicting the ultimate capacity of each configuration. Due to the close proximity of the NEFMAC grid to the face of the transverse joint in the butt joint configuration, it acted as additional shear reinforcement within the deck panels that was not present in the corrugated configurations. This increased shear resistance provided by the NEFMAC reinforcing grid resulted in the significant increase in the ultimate capacity for the butt joint configuration.

***Butt Joint Configuration Failure Mode***

The failure modes for the post-tensioned and non post-tensioned butt joint configurations are described in detail and in the following figures.

***Post-Tensioned Failure Mode***

The failure mode for the post-tensioned butt joint configuration was comprised of major cracking through the depth of the section and across the transverse joint. Figure 48 depicts the failure mode for the post-tensioned butt joint.

Shear cracks along both duct locations in the loaded panel appeared at approximately 70 kips. The first crack appeared in the top surface of the deck panel above the post-tensioning duct and continued to propagate at a 45° angle towards the bottom edge of the panel as the loading and number of cycles increased.

When the test panels were no longer able to withstand an increase in load, the loading was removed and further testing stopped. The panels were removed from the testing rig and a visual inspection of the specimens began. During the visual inspection, cracking was seen in the bottom side of the deck panels. The largest amount of shear cracking on the bottom surface of the deck panel was observed directly underneath the area of loading. These observed cracks outlined the projected image of the loading block, typical to the projection seen in a punching shear test. The shear cracks then progressed outward from the loaded panel, across the transverse joint and into the adjacent deck panel.

As the inspection moved to the top surface of the test specimens, similar cracking patterns were observed. Again, the presence of shear cracks concentrated around the area where the loading was directly applied was noted. Similar shear cracks observed on the bottom surface of the deck panels were seen propagating from the loaded panel, across the transverse joint and into the adjacent panel's top surface.

The crack locations observed in both the top and bottom surfaces of the test panels indicate that the section was cracked and failed through the entire depth of the panels. The shear cracks propagating through the loaded deck panel were typical to the shear cracks expected in a punching shear type test as a concrete plug is being forced through the sample. However, the cracks propagating radially from the applied loading area and crossing the transverse joint into the adjacent deck panel indicate that shear transfer was present within the butt joint configuration even without a concrete-on-concrete bearing mechanism. This shear transfer was a result of the SBA structural adhesive and post-tensioning forces working in concert to keep the two deck panels together and functioning as one monolithic deck section.



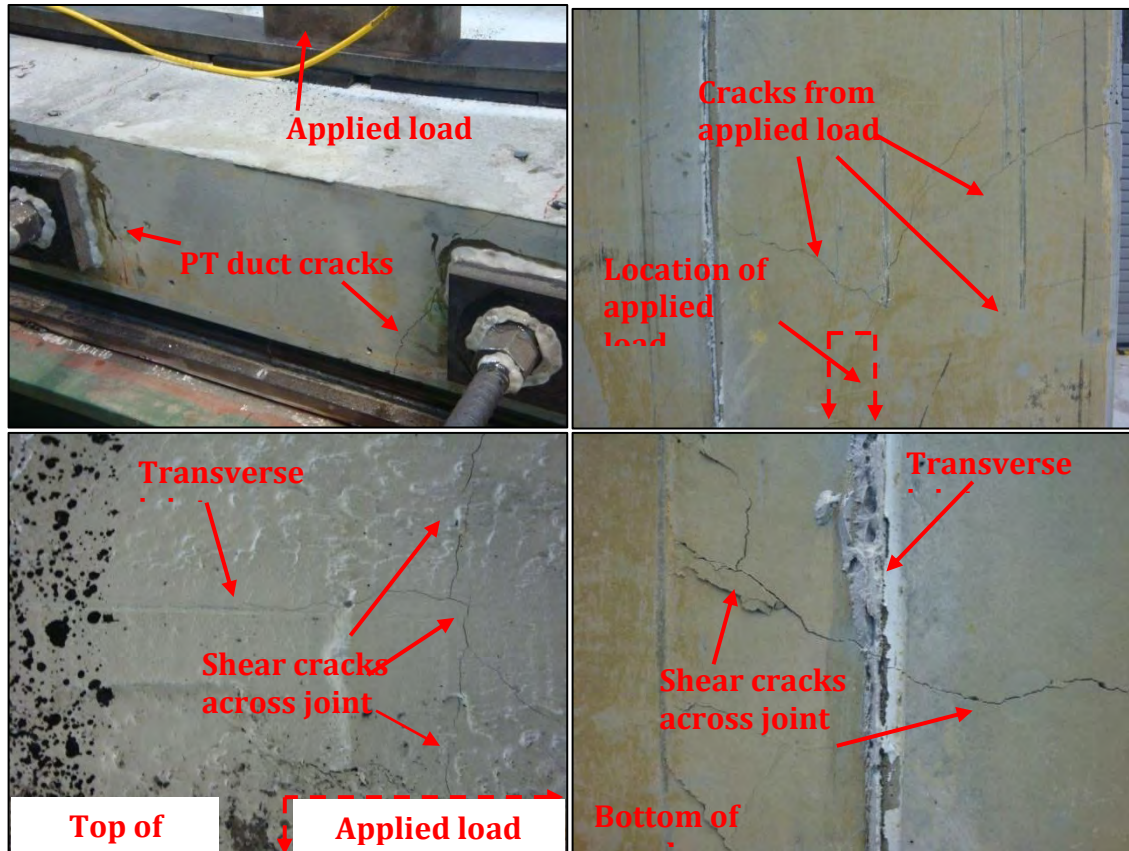

Figure 48: Post-tensioned butt joint failure

### ***Non-Tensioned Failure Mode***

The failure mode for the non-tensioned butt joint configuration was drastically different than the failure mode for the post-tensioned butt joint test panels. The two adhered deck panels completely separated and failed through the depth of the transverse joint. Figure 49 depicts the failure mode for the non post-tensioned butt joint.

The failure plane of the test specimen began in the top surface of the loaded deck panel directly underneath the front edge of the applied load. At approximately 45 kips, spiral cracks in the corners of the loading block area on the top surface of the deck panels were noted. As the load was increased, these spiral cracks began to progress from the corners of the loading block parallel with the transverse joint downward into the deck panels following approximately a 45° angle towards the vertical face of the butt joint. With such large shear cracks present, the failure plane proceeded down the vertical face of the joint, through the post-tensioning ducts to the bottom of the panel.

At the conclusion of testing, a thorough visual inspection was conducted on the failed specimens. Looking at the vertical portion of the butt joint, large sections of delaminated SBA from the joint face were observed. These large sections of



delaminated SBA were found on both faces of the butt joint. In some instances, sections of the SBA were able to be peeled from the surface of the failed deck panels. The ability to peel sections of SBA from the failed deck panel surfaces meant that a lack of sufficient bond between the hardened concrete segments and the SBA occurred. This lack of bond was a result of poor surface preparation of the deck panels prior to application of the SBA.

The close proximity of the NEFMAC grid to the interior face of the transverse joint was also observed during the visual inspection. This close proximity of the NEFMAC grid to the transverse joint resulted in the NEFMAC grid acting as shear reinforcement increasing the shear strength of the panel. The increased shear strength increased the ultimate capacity of the butt joint configuration.

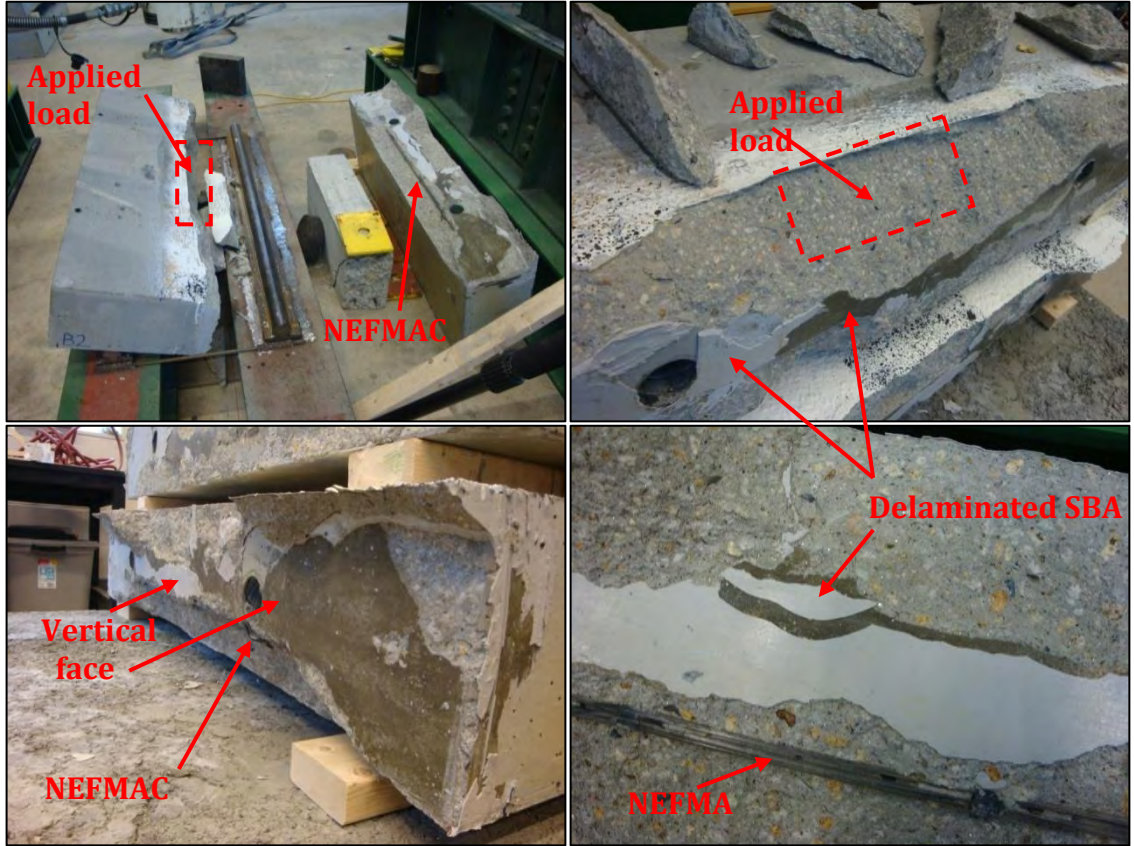

Figure 49: Non-tensioned butt joint failure

**Shear Key Joint Configuration Failure Mode**

The failure modes for the post-tensioned and non-post-tensioned shear key joint configurations are described in detail and in the following figures.

### ***Post-Tensioned Failure Mode***

The failure mode for the post-tensioned shear key configuration was drastically different than the failure mode observed in the other post-tensioned joint configurations. Typically, severe cracking through the depth of the section and across the transverse joint was observed. The shear key panels not only experienced severe cracking through the depth of the section and across the transverse joint, it saw complete failure through the width of the panels. Figure 50 depicts the failure mode for the post-tensioned shear key.

As the applied load reached approximately 30 kips, the keyway grout began to debond from the deck panels. With the keyway separating from the deck panels, as the applied load was increased the downward deflection of the loaded panel began to significantly increase. The panel deflection was resisted by the keyway as well as the post-tensioning force acting to keep the two panels together. The combined action of the post-tensioning and the wedge shape of the keyway applied a compressive force on the adjacent deck panel which induced tensile forces into the deck panel at the vertex of the shear key configuration. As the applied load was increased, the tensile forces at the keyway vertex also increased until a severe crack was formed. This crack ran from the vertex of the shear key configuration through the width of the test specimen along the post-tensioning duct to the exterior face of the deck panel.

As the applied load reached the shear key's ultimate capacity of 56 kips, the crack running through the width of the panel had opened up to nearly 1 inch. The test was stopped and the deck panels were then removed from the test rig and the visual inspection procedure began. The keyway was found to be cracked into three large portions by two cracks travelling through the transverse joint. Large sections of concrete were able to be removed from the deck panels due to the massive shear cracking that had travelled through the width of the panel.

With large concrete sections removed from the deck panels, one of the post-tensioning bars had been completely de-stressed and was removed from the panels.

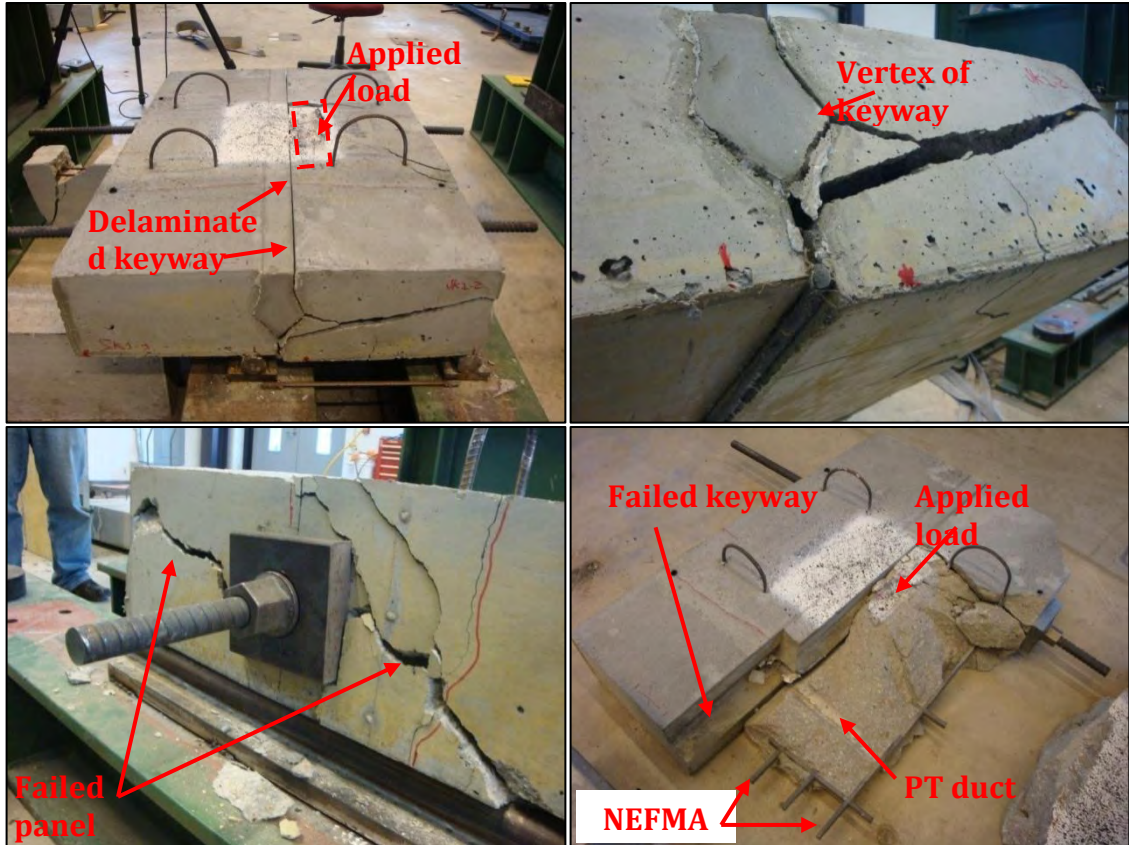

Figure 50: Post-tensioned shear key failure

### ***Non-Tensioned Failure Mode***

The failure mode for the non-post-tensioned shear key was a result of the bond strength between the keyway grout and the deck panels being exceeded resulting in the debonding of the keyway from the loaded deck panel. Figure 51 depicts the failure mode for the non-post-tensioned shear key.

No shear cracking was observed during the test prior to the shear key panels failing at the maximum capacity of 30 kips. The keyway received minimal damage during testing and remained bonded to the non-loaded deck panel, but de-bonded from the loaded shear key panel. A shear failure was observed in the very top portion of the loaded shear key panel starting from the applied load area and travelling parallel to the transverse joint.



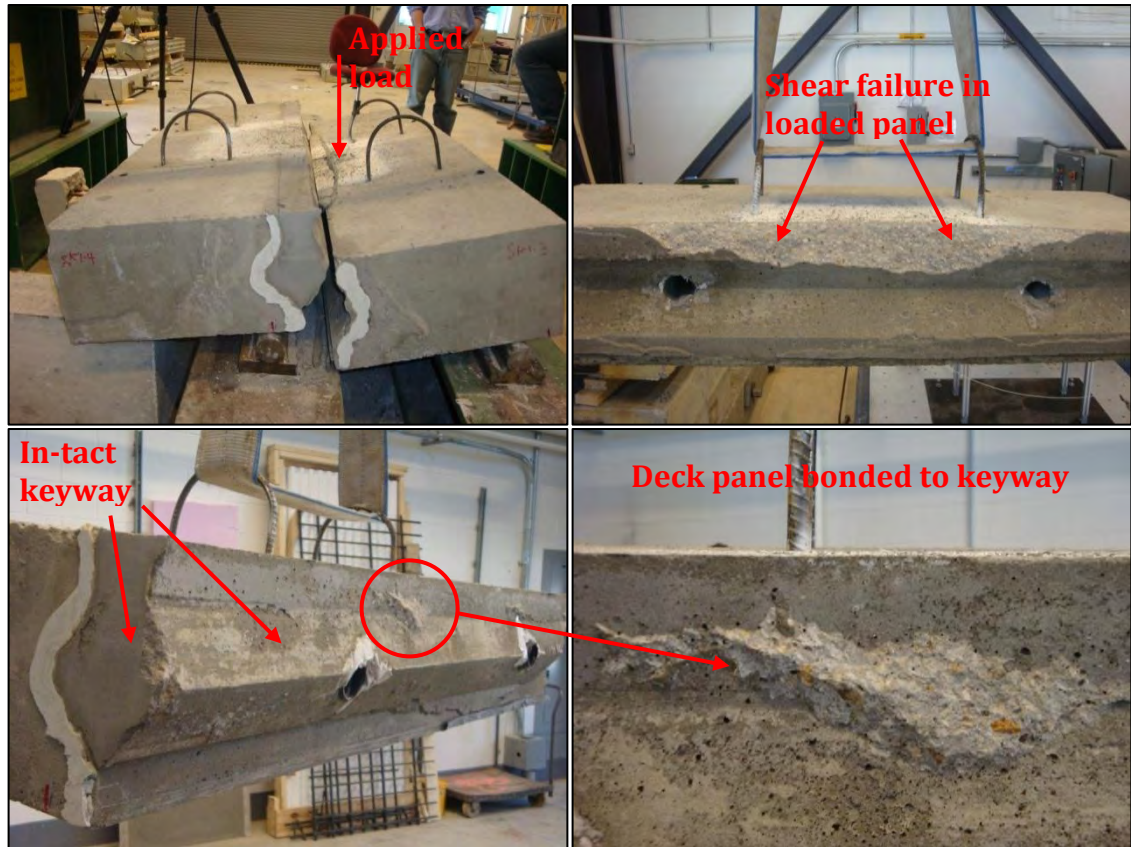

Figure 51: Non-tensioned shear key failure

### ***Angular Corrugated Joint Configuration Failure Mode***

The failure modes for the post-tensioned and non-post-tensioned angular corrugated joint configurations are described in detail and in the following figures.

#### ***Post-Tensioned Failure Mode***

The failure mode for the post-tensioned angular corrugated joint configuration was comprised of major cracking through the depth of the section and across the transverse joint. Figure 52 depicts the failure mode for the post-tensioned angular corrugated configuration.

Shear cracks at both duct locations in the loaded panel appeared at approximately 78 kips. The cracks propagated outward from the loaded area in the top surface of the loaded panel towards the post-tensioning ducts and continued at a 45° angle towards the bottom edge of the panel as the loading and number of cycles increased.

When the test panels were no longer able to resist an increased load, the test was deemed complete. The panels were removed from the testing rig and a visual

inspection of the specimens begun. Severe cracking was found on the bottom side of the deck panels outlining a projected image of the loading block, typical to the projection of cracks seen in a punching shear test. These cracks progressed radially across the transverse joint and into the adjacent deck panel.

As the inspection moved to the top surface of the test specimens, a similar cracking pattern was observed to the bottom surface cracking. The presence of shear cracks concentrated around the area where the loading was directly applied was noted. Similar shear cracks observed on the bottom surface of the deck panels were seen propagating from the loaded panel, across the transverse joint and into the adjacent panel's top surface.

The observed cracking in both the top and bottom surfaces of the test panels indicates that the section has been cracked and failed through the entire depth of the deck panels. The shear cracks propagating through the loaded deck panel are typical to the shear cracks expected in a punching shear type test as a concrete wedge was being forced through the sample. However, the cracks propagating out radially from the applied loading area and crossing the transverse joint into the adjacent deck panel indicate that shear transfer was present within the angular corrugated joint configuration. This shear transfer was accomplished through the concrete-on-concrete bearing mechanism provided by the corrugations, the SBA and post-tensioning forces working in concert to keep the two separate deck panels together and functioning as one monolithic deck section. The presence of the angular corrugations led to the increased ultimate capacity for the transverse joint configuration.

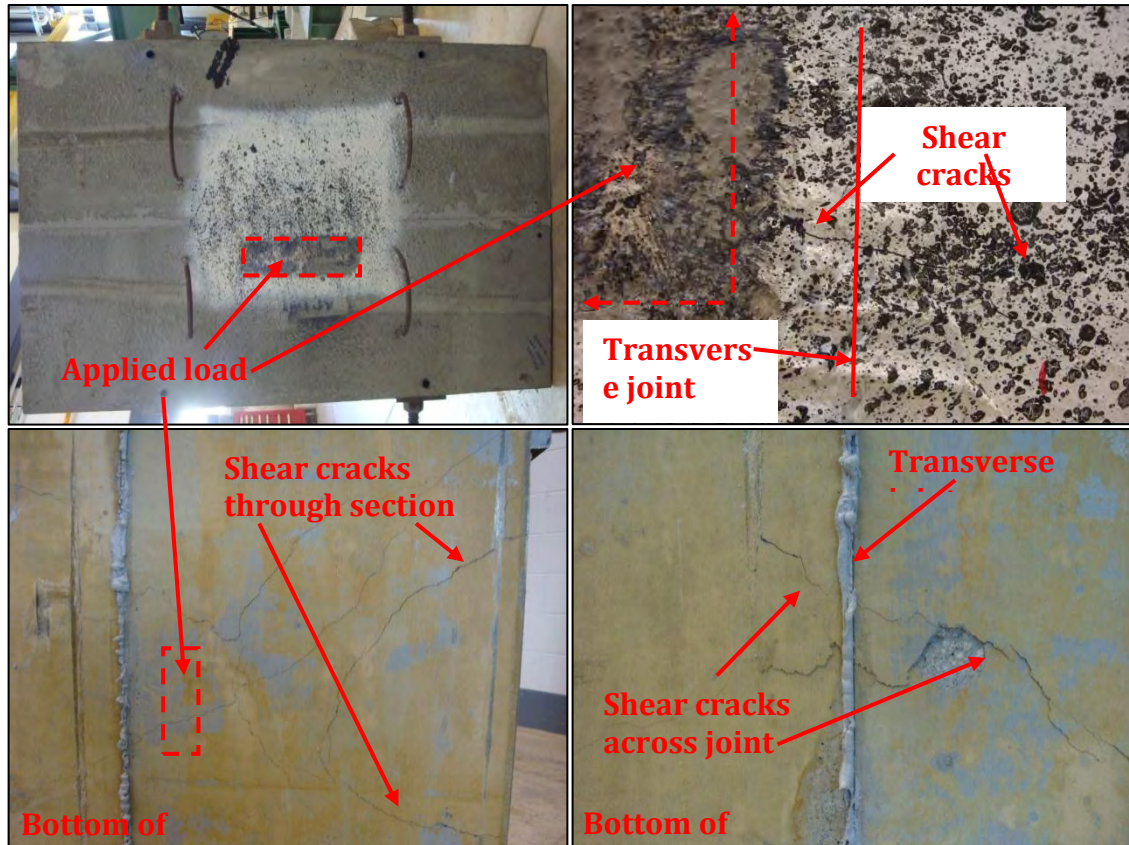

Figure 52: Post-tensioned angular corrugated failure

### ***Non-Tensioned Failure Mode***

The failure mode for the non-post-tensioned angular corrugated joint configuration was comprised of a shear failure through the depth of the deck panel along the transverse joint face resulting in total separation of the deck panels. Figure 53 depicts the failure mode for the non-post-tensioned angular corrugated configuration.

The failure plane of the test specimen began in the top surface of the loaded deck panel directly underneath the front edge of the applied load. At approximately 38 kips, spiral cracking in the corners of the loading block were noted on the top surface of the deck panels. As the load was increased, these spiral cracks began to progress from the corners of the loading block running parallel with the transverse joint. With such a large shear crack now present, the failure plane proceeded down through the section of deck panel until the test assembly was severed into two separate deck panels.

At the conclusion of testing, a thorough visual inspection was conducted on the failed specimens. The tongues of the non-loaded deck panel were sheared from their respective panel. They were found to be still adhered within the groove portions of the adjacent loaded deck panel. This failure mode reflects a similar predicted failure pattern defined as plane 2 described in section 3.2.3 (Robert, 2009).



Small portions of delaminated SBA were observed within the transverse joint face. These delaminated sections were a result of poor surface preparation of the deck panel transverse joint prior to SBA application.

Also discovered during the visual inspection was the larger than expected distance of the NEFMAC reinforcing grid from the transverse joint face. This large distance forced all of the shear stresses induced by the applied loading into the deck panel concrete and none into the reinforcing grid resulting in the decreased ultimate capacity of the angular corrugated configuration in comparison with the butt joint.

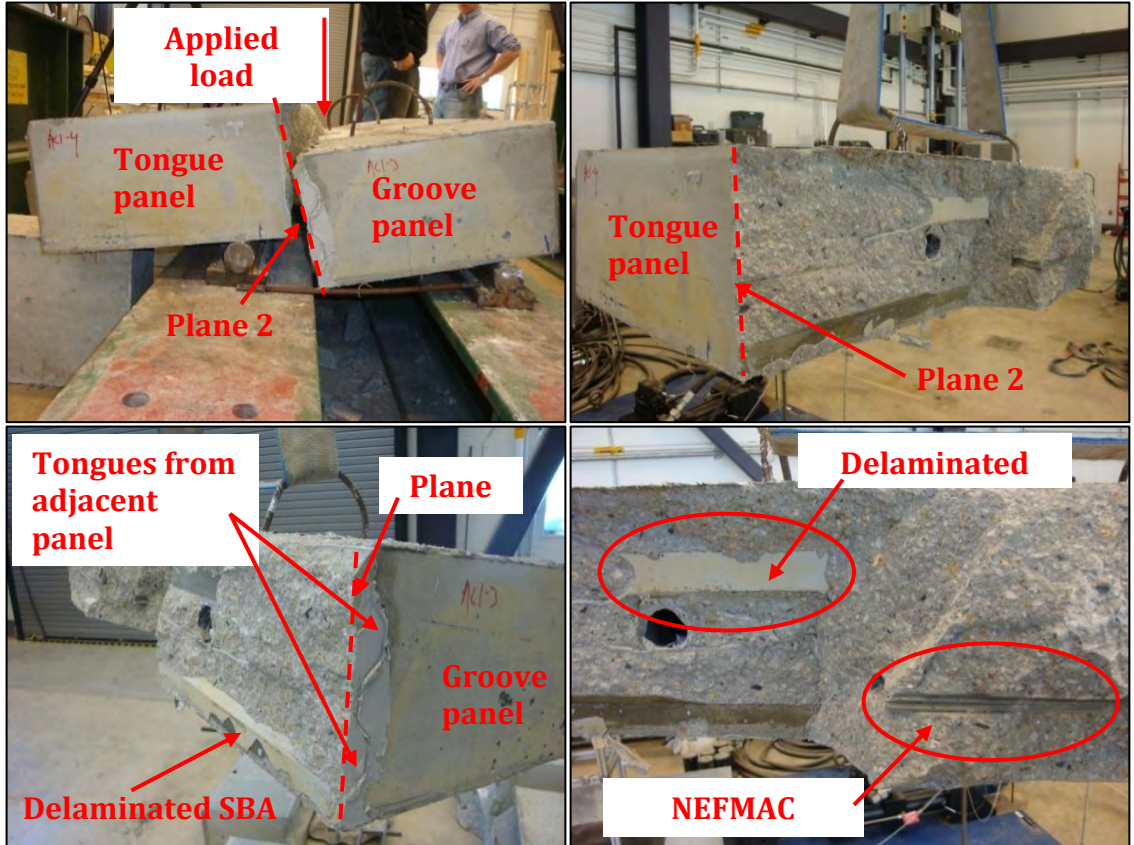

Figure 53: Non-tensioned angular corrugated failure

**Round Corrugated Joint Configuration Failure Mode**

The failure modes for the post-tensioned and non-tensioned round corrugated joint configurations are described in detail and in the following figures.

### ***Post-Tensioned Failure Mode***

The failure mode for the post-tensioned round corrugated joint configuration was comprised of major cracking through the depth of the section and across the transverse joint. Figure 54 depicts the failure mode for the post-tensioned round corrugated configuration.

Shear cracks at both duct locations in the loaded panel appeared at approximately 76 kips. The crack first appeared in the top surface of the deck panel and continued to propagate at a 45° angle towards the bottom edge of the panel as the loading and number of cycles increased.

When the test panels were no longer able to withstand an increase in load, the test was deemed complete. The panels were removed from the testing rig and a visual inspection of the specimens began. During the visual inspection, severe cracking was seen in the bottom side of the deck panels. A large amount of shear cracking was observed on the bottom surface of the deck panel directly underneath the load application area. These observed cracks outlined the projected image of the loading block, typical to the projection seen in a punching shear test. The shear cracks then progressed outward from the loaded panel, across the transverse joint and into the adjacent deck panel.

As the inspection moved to the top surface of the test specimens, similar cracking patterns were observed. Again, the presence of shear cracks concentrated around the area where the loading was directly applied was noted. Similar to the shear cracks observed on the bottom surface of the deck panels, shear cracks were seen propagating from the loaded panel, across the transverse joint and into the adjacent panel's top surface.

The observed cracking in both the top and bottom surfaces of the test panels indicated that the section had been cracked and failed through the entire depth of the panels. The shear cracks propagating through the loaded deck panel were typical to the shear cracks expected in a punching shear type test as a concrete wedge was being forced through the sample. The cracks propagating out longitudinally from the applied loading area and crossing the transverse joint into the adjacent deck panel indicated that shear transfer was present within the round corrugated joint configuration. This shear transfer was a result of the concrete-on-concrete bearing mechanism provided by the corrugations, SBA structural adhesive and post-tensioning forces working in concert to keep the two separate deck panels together and functioning as one monolithic deck section. The largest shear area provided by the round corrugations led to the highest achieved ultimate capacity of all the joint configurations.



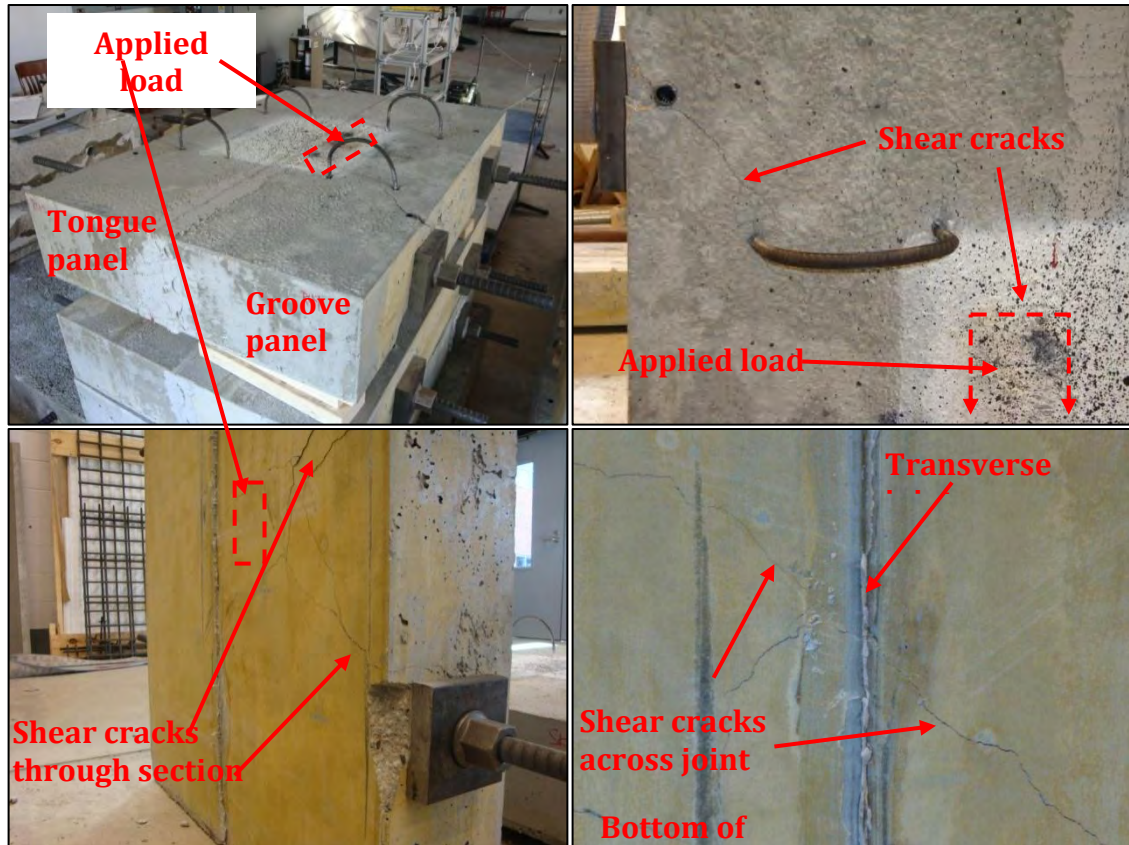

Figure 54: Post-tensioned round corrugated failure

### ***Non-Tensioned Failure Mode***

The failure mode for the non-post-tensioned round corrugated joint configuration was comprised of a shear failure through the depth of the deck panel along the transverse joint face resulting in total separation of the deck panels. Figure 55 depicts the failure mode for the non-post-tensioned round corrugated configuration.

The failure plane of the test specimen begins in the top surface of the loaded deck panel directly underneath the front edge of the applied load. At approximately 46 kips, spiral cracking in the corners of the loading block were noted on the top surface of the deck panels. As the load was increased, these spiral cracks began to progress from the corners of the loading block running parallel with the transverse joint. With such a large shear crack now present, the failure plane proceeded down through the section of deck panel until the test assembly was severed into two separate panels.

At the conclusion of testing, a thorough visual inspection was conducted on the failed specimens. The tongues of the non-loaded deck panel were sheared from their respective panel. They were still adhered within the groove portions of the adjacent

loaded deck panel. This failure mode reflects a similar predicted failure pattern within plane 2 as suggested in section 3.2.4 (Robert, 2009).

No delaminated SBA was found within the transverse joint face, suggesting sufficient surface prep prior to application was achieved.

Also discovered during the visual inspection was the larger than expected distance of the NEFMAC reinforcing grid from the transverse joint face. This large distance forced all of the shear stresses induced by the applied loading into the deck panel concrete and none into the reinforcing grid resulting in the decreased ultimate capacity of the round corrugated configuration in comparison with the butt joint.

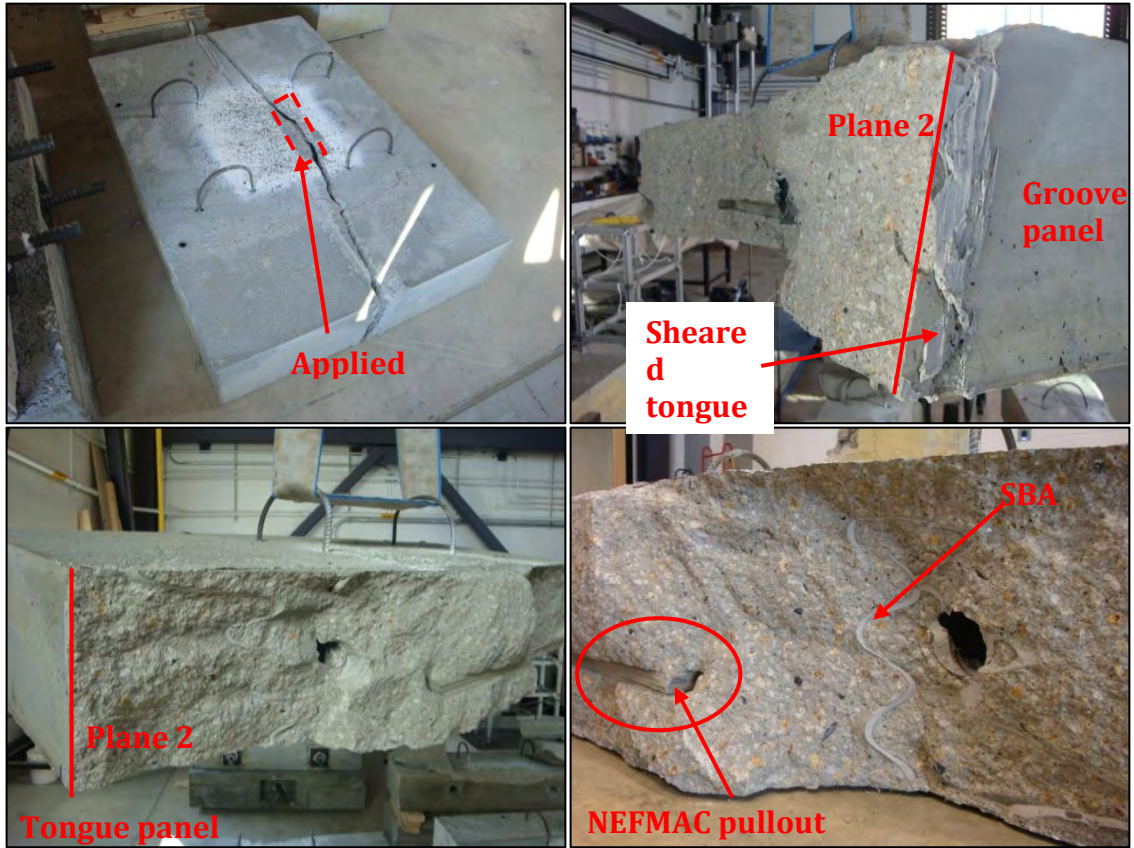

Figure 55: Non-tensioned round corrugated failure

# CONCLUSIONS AND RECOMMENDATIONS

## Conclusions

The following sections highlight the major findings of this research in regards to the post-tensioning system, the transverse joint material and the varying transverse joint configurations.

### ***Conclusions for the Post-Tensioning System***

- The post-tensioning system components provided by DSI all proved successful in performing their respective roles in the system
- The post-tensioning bars, bearing plates and self-centering anchor nuts were successful in transferring the post-tensioning forces into the deck panels
- The post-tensioning formwork provided the required access points within the deck panels
- The jacking equipment proved successful in its ability to quickly and safely induce the required stress levels in the post-tensioning bars to achieve the required compressive stress in the deck panels

### ***Conclusions for the Transverse Joint Material, Sikadur<sup>®</sup> 31, SBA***

- Proved an effective alternative to cementitious grout
- Volumetric proportioning allows for quick and easy material preparation
- Adequately thixotropic, did not sag or slough off vertical faces
- Easily applied with a gloved hand
- Cured SBA yielded a uniform bearing surface within the transverse joint providing an even stress distribution from the post-tensioning operation verified by the absence of cracking and spalling of the test panels when compared to the damage done to the feasibility test panels during prior post-tensioning operations carried out on un-cured SBA

### ***Conclusions for the Transverse Joint Material, SikaGrout<sup>®</sup> 212***

- Proved successful in filling the keyway formed between adjacent deck panels
- The extra steps required in sealing the ends of the panels were time consuming
- Some leakage of the grout material is inherent
- Proper surface preparation of the deck panels is critical
- Bond strength between the deck panels and keyway proved to be a significant factor in the ultimate capacity for the shear key configuration

**Conclusions for the Transverse Joint Configurations**

Each transverse joint configuration developed, fabricated, assembled and tested in this research was critiqued to determine the advantages and disadvantages each configuration type offers. The critique results have been summarized in Table 9 followed by the explanation of results for each portion of the critique.

Configuration	Shear Area		Tolerance Requirements	Difficulty of Fabrication	Ease of Assembly	Load Capacity	Failure Mode
	Plane 1	Plane 2					
Butt	None	None	Minimal	Minimum	Simple	Good	Cracked
Shear Key	Good	Good	Typical	Typical	Difficult	Fair	Destroyed
Angular Corrugated	Fair	Great	Tight	Difficult	Moderate	Great	Cracked
Round Corrugated	Excellent	Excellent	Tight	Extreme	Moderate	Excellent	Cracked

Table 9: Transverse joint configuration critique summary

**Shear Area**

The shear areas provided for each transverse joint configuration have previously been highlighted in detail in section 3.2 (Robert, 2009). It was shows that the amount of shear area provided by the varying joint configurations is as follows:

$$Round\ Corrugated > Angular\ Corrugated > Shear\ Key > Butt$$

**Tolerance Requirements**

Due to the lack of corrugations or voids cast in the butt joint configuration, the required tolerances for it are minimal to none. As long as typical pre-cast concrete tolerances are maintained, vertical panel edges and post-tensioning duct alignment are easily obtainable.

The shear key joint configuration only requires a slightly higher tolerance than a butt joint to ensure that the void formed in adjacent panels is correctly aligned. Since the shear key joint configuration is currently the industry standard for deck panels, pre-casters are familiar with the required tolerance levels for quality shear key deck panels.

The angular corrugated and round corrugated joint configurations require extremely tight tolerances to ensure adjacent panels are correctly aligned with each other. Without such high tolerance requirements, cracking and spalling of the deck panels may occur if miscast male-female corrugations are force-fit together producing locations with extreme stress. With the increased concrete-on-concrete bearing surfaces in the corrugated configurations, if the tight tolerances are not imposed and met, the likelihood of panel misalignment or lack of fit is significantly increased. Misaligned panels or panels incorrectly fitted together may result in their rejection for use, and add increased time in the production phase resulting in costly delays to a deck

replacement project. Match-casting techniques may be used at the fabricator's discretion.

### ***Difficulty of Fabrication***

As a result of the minimal tolerance requirements, the butt joint was the simplest and easiest configuration to fabricate.

With the increased tolerance requirements for the shear key joint, the difficulty of fabrication was increased. However, due to the symmetric design of the configuration and familiarity of shear key deck panel fabrication, the level of fabrication difficulty was relatively low and typical for pre-casters.

The angular corrugated joint configuration was considered difficult to fabricate due to its tight tolerance requirements. Due to the male-female connection type of the configuration, the two transverse panel edges differ in their geometric makeups. Great care must be taken by the pre-casters during form assembly to ensure that the correct transverse edge forms are utilized during panel fabrication as the edge configurations are not interchangeable. However, the use of angular geometric shapes does allow for typical construction methods and materials to be implemented by pre-casters for the angular corrugated joint.

The round corrugated joint configuration was by far the most difficult to fabricate. In addition to the tight tolerances imposed on this configuration, the lack of angular geometry does not allow for typical construction methods and materials to be utilized by pre-casters. Highly trained laborers or custom forms are required to generate such high precision forms. Similar to the angular corrugated configuration, the asymmetric nature of the round corrugated configuration requires the use of two different edge forms during the fabrication of a single panel. Increased attention to detail was required to ensure the correct form assemblies are in place prior to casting the round corrugated transverse joint configuration deck panels.

### ***Ease of Assembly***

With the lack of corrugations, the placement of SBA to the transverse joint for a butt joint was the simplest of all the configurations. As well as aiding in SBA application, the lack of corrugations also allowed for easier panel alignment resulting in a more rapid assembly.

The shear key configuration was the most difficult of all the configurations to assemble. The extra steps required in adhering the backer rod material, sealing the keyway ends and placing the grout resulted in a fairly labor intensive, slow assembly procedure.

Both the angular and round corrugated joint configurations have been listed as moderately difficult to assemble. Extra care must be taken during the application of the SBA material to ensure that an adequate thickness of material covers all edges of the corrugations to ensure there are no gaps or voids present within the transverse

joint. Panel alignment was aided by the lubrication effect of the SBA and the self-centering nature of the corrugations.

### ***Load Capacity***

The load capacity of each transverse joint configuration has been highlighted in Table 7. The ultimate capacity of the varying joint configurations was as follows:

### ***Failure Mode***

The failure modes for the varying joint configurations were highlighted in detail throughout section 6.2 (Robert, 2009).

The failure mode for the post-tensioned butt, angular and round corrugated joint configuration deck panels encompassed severe shear cracking through the depth of the section and across the transverse joint. The post-tensioned shear key failure mode resulted in a completely destroyed deck panel.

The failure mode for the non-tensioned configurations was complete failure. All of the configurations were separated into the individual deck panels that comprised the test assembly. In the butt, angular, and round corrugated joint configurations, the failures resembled predicted failure planes laid out for the respective configuration in section 3.2 (Robert, 2009). The shear key joint failure was a result of the keyway grout material de-bonding from the deck panels.

### **Recommendations**

The following sections describe the recommendations put forth based on the results of this research in regard to the post-tensioning procedure, transverse joint filler material and the transverse joint configuration.

### ***Post-Tensioning Procedure***

The post-tensioning system proved to be a success. Determining when to post-tension pre-cast concrete deck elements was found to be a crucial development for the overall system performance. It is strongly recommended that post-tensioning operations do not proceed until the SBA used in the transverse joint has fully set. By implementing the snug-tightening procedure and expelling excess SBA from the transverse joint, a uniform bearing surface is formed. The excess SBA is allowed to leave the transverse joint and reduce the risk of inducing excessive stresses into the joint and possibly causing cracking or spalling of the deck panels. Once set, the uniform bearing surface provided by the SBA allows for even stress distributions across the face of the transverse joint, allowing for the post-tensioning compressive forces induced to act uniformly across the section.

### ***Transverse Joint Material***

The Sikadur® 31, SBA product performed exceptionally well and is deemed a critical component of the rapid bridge deck replacement system.

### ***Transverse Joint Configuration***

Based on the results of this research, it is recommended that the round corrugated transverse joint configuration be considered for further development and testing. This configuration, in concert with the SBA provided the highest ultimate capacity and most rapid and efficient manner of installation.

### ***Differential Deflection Considerations***

The use of DIC technologies for deflection data acquisition is extremely promising. The convenience, speed and precision of the cameras exponentially decreases the labor intensity and reader error inherently present when utilizing multiple analog dial gauges to acquire deflection data. The possibility of syncing the load cell outputs with the DIC greatly reduces the effort required to post-process test results when comparing deflection values with given loads.

However, the conversion from the global coordinate system of the DIC to the local coordinate system of the test specimens has not yet been experimentally verified for this particular application. Because of this, proven deflection values were not obtained and therefore not included in this research.



## WORKS CITED

- AASHTO. (2008). *Bridging the Gap - Restoring and Rebuilding the Nation's Bridges*. AASHTO.
- AASHTO. (2002). *AASHTO Standard Specification for Highway Bridges, 17<sup>th</sup> Edition*. AASHTO.
- ACI 318-05. (2005). *Building Code Requirements for Structural Concrete and Commentary*. Farmington Hills, MI.
- American Highway Users Alliance. (2004). *Unclogging America's Arteries, Effective Relief for Highway Bottlenecks, 1999-2004*. Washington D.C.: American Highway Users Alliance.
- ASCE. (2009). *2009 Report Card for America's Infrastructure*. ASCE.
- ASTM A 722/ A 722M – 05. (2005). *Standard Specification for Uncoated High-Strength Steel*. West Conshohocken: ASTM International West Conshohocken: ASTM International.
- ASTM C 39/C 32M – 02. (2002). *Standard Test Method for Compressive Strength of Cylindrical Concrete Specimens*, West Conshohocken: ASTM International.
- ASTM C 192/C 192M – 02. (2002). *Standard Practice for Making and Curing Concrete Specimens in the Laboratory*. West Conshohocken: ASTM International.
- ASTM C 231 – 04. (2004). *Standard Test Method for Air Content of Freshly Mixed Concrete by the Pressure Method*. West Conshohocken: ASTM International.
- ASTM C 469 – 02, (2002). *Standard Test Method for Static Modulus of Elasticity and Poission's Ratio of Concrete in Compression*. West Conshohocken: ASTM International.
- ASTM C 496 – 04, (2004). *Standard Test Method for Splitting Tensile Strength of Cylindrical Concrete Specimens*. West Conshohocken: ASTM International.
- Bowman, M., Yost, J., Steffen, R., & Goodspeed, C. (2003). Diagnostic Testing and In-Service Performance Monitoring of a CFRP Reinforced HPC Bridge Deck. *Second New York City Bridge Conference - Recent Developments in Bridge Engineering* (pp. 361-371). New York, NY: Bridge Engineering Association.
- Briggs, R. J. (2007). *Structural Modeling of Full Depth Concrete Deck Panels*.
- Dywidag Systems International. (2006, April). *DSI America*. Retrieved February 18, 2009, from DSI America Downloads:  
[http://www.dsiamerica.com/uploads/media/DSI-USA\\_Bonded\\_Post\\_Tensioning\\_Systems\\_us.pdf](http://www.dsiamerica.com/uploads/media/DSI-USA_Bonded_Post_Tensioning_Systems_us.pdf)
- FHWA. (2008, December 22). *Highway History*. Retrieved April 6, 2009, from Federal Highway Administration: <http://www.fhwa.dot.gov/infrastructure/history.cfm>
- National Instruments. (2005). *SCXI Chassis User Manual*. Austin: National Instruments.
- National Instruments. (2005). *SCXI-1314T Front-Mounting TEDS Terminal Block for NI SCXI-1520*. Austin: National Instruments.
- National Instruments. (2005). *SCXI-1520 User Manual*. Austin: National Instruments.
- NCHRP. (2003). *Prefabricated Bridge Elements and Systems to Limit Traffic Disruption During Construction*. Washington D.C.: NCHRP.



- NHASCE. (2006). *2006 Report Card for New Hampshire's Infrastructure*. NHASCE.
- NHDOT Bureau of Bridge Design. (1999). Rollins Road Bridge Over B&M Railroad and Main Street Plans.
- NHDOT Bureau of Bridge Design. (2008). *Bridge Inspection Report - Haverhill 099/145*. NHDOT.
- NHDOT Bureau of Bridge Design. (2007). *Bridge Inspection Report - Rollinsford 091/085*. NHDOT.
- PCI. (2005). All-Precast Substructure Accelerates Construction of Prestressed Concrete Bridge in New Hampshire. *PCI Journal* , 26-39.
- Ram-Pac International, Inc. (2003). *Item # TC-150-DA6, Solid Model DA Heavy Duty Double-Acting Cylinders*. Retrieved March 24, 2009, from RAM-PAC International, Inc. A Subsidiary of Hader Industries, Inc.: <http://rampac.thomasnet.com/item/double-acting-hydraulic-cylinders/solid-model-da-heavy-duty-double-acting-cylinders/rc-150-da-6?&seo=110&plpver=10>
- Salzer, D. L. (2008). *Rapid Bridge Deck Replacement*.
- Schmeckpeper, E. R. (1992). *Performance of Concrete Beams and Slabs Reinforced with FRP Grids*.
- Sika Corporation. (2008, July). *Product Data Sheet - Sikadur 31, SBA*. Retrieved February 17, 2009, from Sika Corporation, Inc. USA: <http://www.sikaconstruction.com/tds-cpd-Sikadur31SBA-us.pdf>
- Sika Corporation. (2006, February 10). *Sikadur 31 SBA*. Retrieved April 9, 2009, from Sika Corporation Case Studies By Product: [http://www.sikaconstruction.com/construction-casestudies\\_in\\_construction\\_product-Sikadur31SBA](http://www.sikaconstruction.com/construction-casestudies_in_construction_product-Sikadur31SBA)
- Sika Corporation. (2003, 6). *SikaGrout 212 Product Data Sheet*. Retrieved April 16, 2009, from Sika Construction: <http://www.sikaconstruction.com/tds-cpd-SikaGrout212-us.pdf>
- Sipple, J. D. (2008). *Structural Modeling and Monitoring of the Rollins Road Bridge for Condition Assessment*.
- Transducer Techniques. (2009). *CLC Series Load Cell*. Retrieved March 24, 2009, from Transducer Techniques: <http://www.ttloadcells.com/CLC-Load-Cell.cfm>
- Woodrow Wilson Bridge Project. (2001). *The Woodrow Wilson Bridge Project*. Retrieved April 9, 2009, from <http://www.wilsonbridge.com/index.htm>

## APPENDIX A – PANEL DESIGN

### Post Tensioning Design

#### Panel Properties

$$Depth_{\text{Panel}} = 8.50 \text{ in.}$$

$$Width_{\text{Panel}} = 48.00 \text{ in.}$$

$$Tributary \text{ Width} = Depth_{\text{Panel}} \times Width_{\text{Panel}} = 408 \text{ in}^2$$

$$PT_{\text{Req'd}} = 400 \text{ psi}$$

#### Post-Tensioning Bar Properties

$$PT \text{ Force}_{\text{Req'd}} = Tributary \text{ Width} \times PT_{\text{Req'd}} = 408 \text{ in}^2 \times 400 \text{ psi}$$

$$PT \text{ Force}_{\text{Req'd}} = 163.2 \text{ kips}$$

$$\# \text{ of } PT \text{ Bars per panel} = 2$$

$$PT \text{ Force}_{\text{Req'd per Bar}} = 81.6 \text{ kips}$$

$$Area_{\text{Bar}} = 0.850 \text{ in}^2$$

$$Stress_{\text{Bar}} = PT \text{ Force}_{\text{Req'd per Bar}} / Area_{\text{Bar}} = 96.0 \text{ ksi}$$

$$f_{\text{pu}} = 150.0 \text{ ksi}$$

$$Allowable \text{ Stress}_{\text{Bar}} = 0.70f_{\text{pu}} = 105.0 \text{ ksi} \quad \text{ACI 318-05 18.5.1(c)}$$

$$96.0 \text{ ksi} \leq 105.0 \text{ ksi} \quad \text{"OK"}$$

According to the Jack Calibration Form provided by DSI in Appendix X, stress each bar to a dial gauge value of 3,950 psi to achieve the required compression stress in the transverse joint.

## Panel Dimension Design

### ACI 318-05 Section 10.7.1(a)

$$l_n \leq 4 * Depth_{\text{Panel}}$$

$$l_n \leq 4 * 8.50''$$

$$l_n \leq 34.0''$$

Therefore, with 2, 16.00'' specimens assembled

$$l_n = 32.00''$$

$$32.00'' \leq 34.00'' \quad \text{“OK”}$$

### ACI 318-05 Section 10.7.1(b)

$$2 * Depth_{\text{Panel}} = 17.00''$$

Location of concentrated load = 14.00'' from support face

$$14.00'' \leq 17.00'' \quad \text{“OK”}$$

# APPENDIX B – TRANSVERSE JOINT CONFIGURATION DIMENSIONS

## Butt Joint Configuration

### Typical Butt Joint Cross Section



## Shear Key Configuration

### Typical Shear Key Cross Section

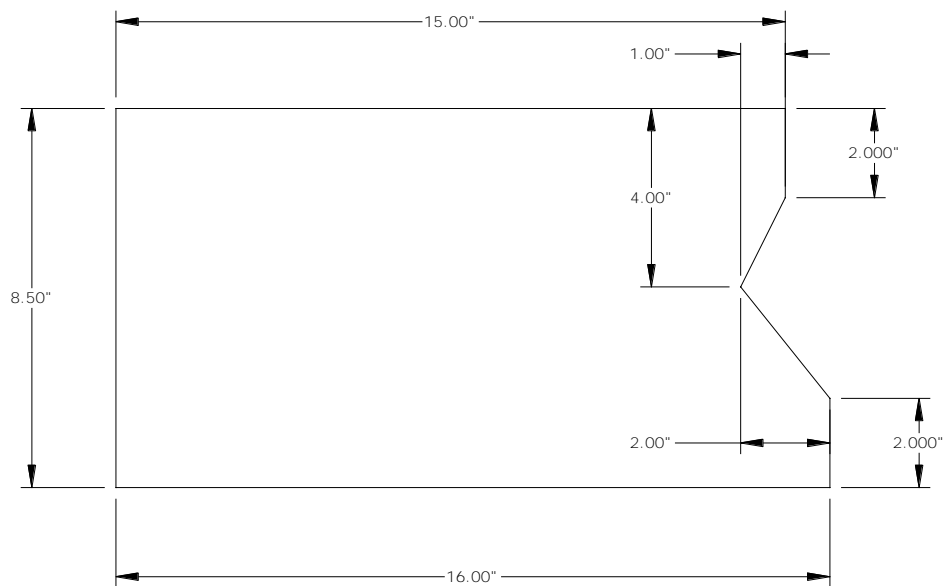

**Angular Corrugated Configuration**

**Angular Corrugated Tongue Cross Section**

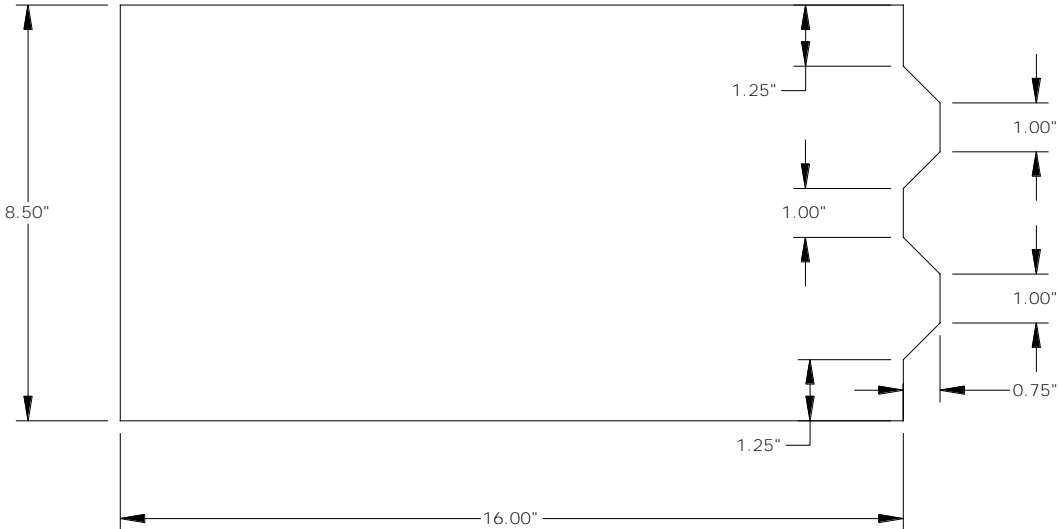

**Angular Corrugated Groove Cross Section**

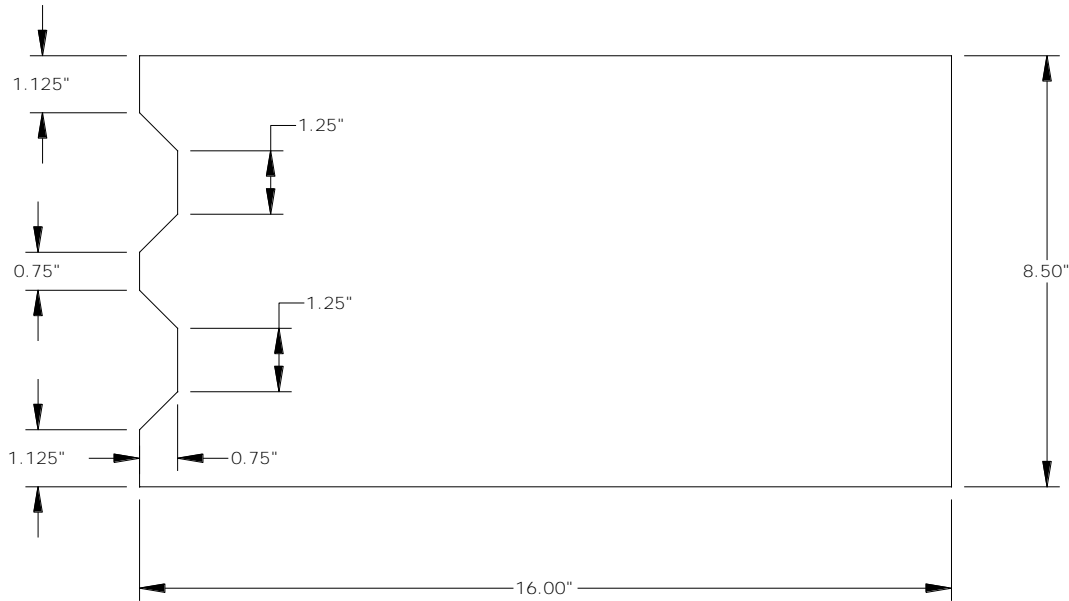

**Round Corrugated Configuration**

**Round Corrugated Tongue Cross Section**

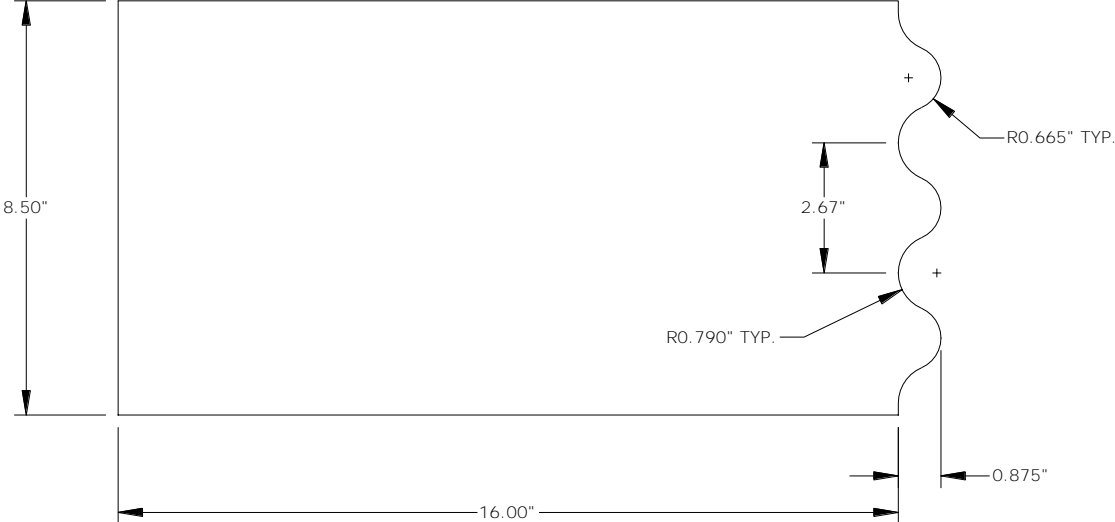

**Round Corrugated Groove Cross Section**

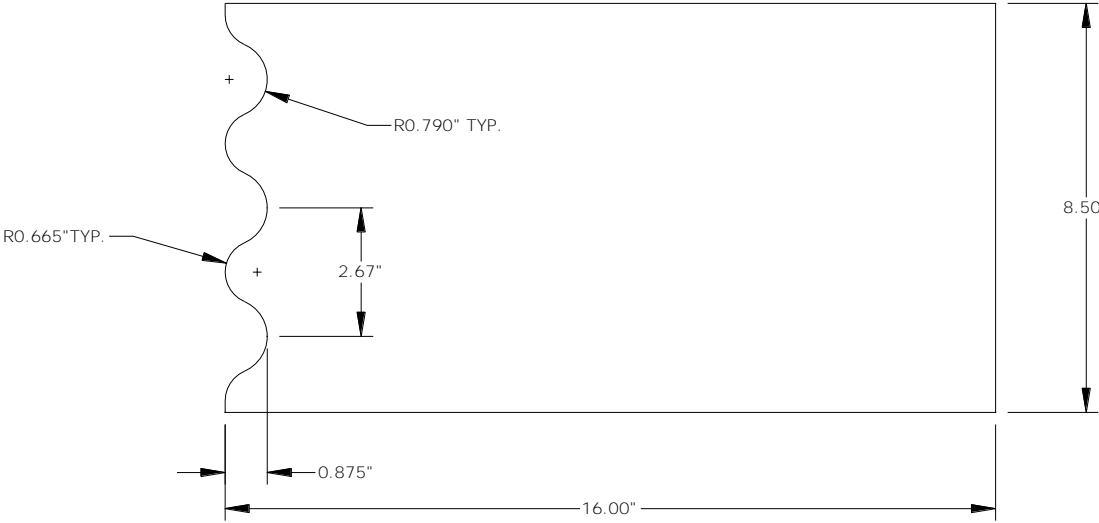

# APPENDIX C – CONCRETE MATERIAL PROPERTIES



## DELIVERY TICKET

MANCHESTER REDIMIX CONCRETE  
 NASHUA REDIMIX CONCRETE  
 PERSONS CONCRETE  
 SEACOAST REDIMIX CONCRETE

REMIT TO: P.O. BOX 414077 BOSTON, MA 02241-4077, TEL 800-998-4434

CONTRACT NO.	DATE	TRUCK	DRIVER	CTRL NO.
				648727
UNIVERSITY OF NH		CIVIL ENG. LAB/ART'S WAY/DURHAM		648727

LOAD QTY	PRODUCT	DESCRIPTION	ORDERED	DELIVERED	UNIT PRICE	AMOUNT
6.00	930035	REDIFLOW	6.00	6.00		
6.00	979000	WINTER SERVICE	1.00	6.00		
1.00	998320	FUEL SURCHARGE	1.00	1.00		

MILL RD/ R ON ACADEMIC RD/ PAST BUSINESS SCHOOL/ L ON ARTS WAY AF  
 TER PARSONS HALL

DEPART PLANT	ARRIVE JOB SITE	START DISCHARGE	FINISH DISCHARGE	WATER ADDED	TEST TAKEN
:	10:14	:	:	:	SLUMP: AIR:

In the event of delivery beyond curb line this company will not assume liability for damage to sidewalk, driveway, or other property, to which contractor or agent has directed the truck to cross.

We will not be responsible for strength of concrete to which additional water has been added.

### MSDS ON REVERSE SIDE

Freshly mixed cement, mortar, grout or concrete may cause skin irritation. Avoid direct contact where possible and wash exposed skin areas promptly with water.

If any cementitious material gets into the eye, rinse immediately and repeatedly with water and get prompt medical attention.

Compressive strength as noted is with 5% air content and a 4" slump.

X

SIGNATURE OF CUSTOMER OR REPRESENTATIVE

TRUCK: 4038 USER: USER DISP TICKET NUM: 648727 TICKET NUM: 68793 TRUCK ID: 83754 TIME: 09:25 DATE: 01/15/2009

LOAD SIZE	MIX CODE	DESIGN QTY	REQUIRED	BATCHED	VAR	% VAR	MOISTURE	ACTUAL WAT
6.00 yd	930035						0	84974
3/8		1450 lb	8951 lb	8900 lb	-61	-4.2%	3.000% M	31.06 g/l
SAND		1440 lb	9072 lb	9000 lb	-72	-5.0%	5.000% M	51.36 g/l
TYPE II		705.0 lb	4230.0 lb	4330.0 lb	+100.0	+2.36%		
ART RED		7.00 /C	296.10 oz	296.00 oz	-0.10	-0.03%		
AIR		5.00 oz	30.00 oz	30.00 oz	0.00	0.00%		
WATER		31.40 gal	75.36 gal	76.00 gal	0.64	0.85%		76.00 g/l

NON-SIMULATED NUM BATCHES: 1  
 LOAD TOTAL: 22805 lb DESIGN W/C: 0.372 WATER/CEMENT: 0.3631 DESIGN WATER: 188.4 gal ACTUAL WATER: 158.4 gal TO ADD: 30.0 gal  
 SLUMP: 4.00" WATER IN TRUCK: 0.0 gal ADJUST WATER: 0.0 gal/load TRIM WATER: -5.0 gal 7yd

PLANT H2O x 0.33 = LBS TOTAL DEL H2O GAL  
 SITE H2O x 0.33 = LBS TOTAL H2O GAL  
 TOTAL WEIGHT LBS/ CY = LBS/CY

TEST RESULTS YIELD CALCULATIONS \*SCALE INSP DATE: put in inspection

SLUMP: \_\_\_\_\_ GROSS: \_\_\_\_\_ LBS (AIR METER)  
 AIR: \_\_\_\_\_ TARE: \_\_\_\_\_ LBS  
 CONC TEMP: \_\_\_\_\_ F NET: \_\_\_\_\_ LBS  
 AMB TEMP: \_\_\_\_\_ F FACTOR: \_\_\_\_\_ STATE INSPECTOR: \_\_\_\_\_  
 WEATHER: \_\_\_\_\_ UNIT WT: \_\_\_\_\_ LBS/CF  
 YIELD: \_\_\_\_\_ LBS/CY = \_\_\_\_\_ CF/CY TOTAL WATER: \_\_\_\_\_ LBS=WC RATIO  
 TOTAL CEMENT: \_\_\_\_\_ LBS

23 1/2 spread  
 3% AIR 57° Temp

36.50  
 146.0 pcf

CUSTOMER COPY



## Compressive Strength vs. Time

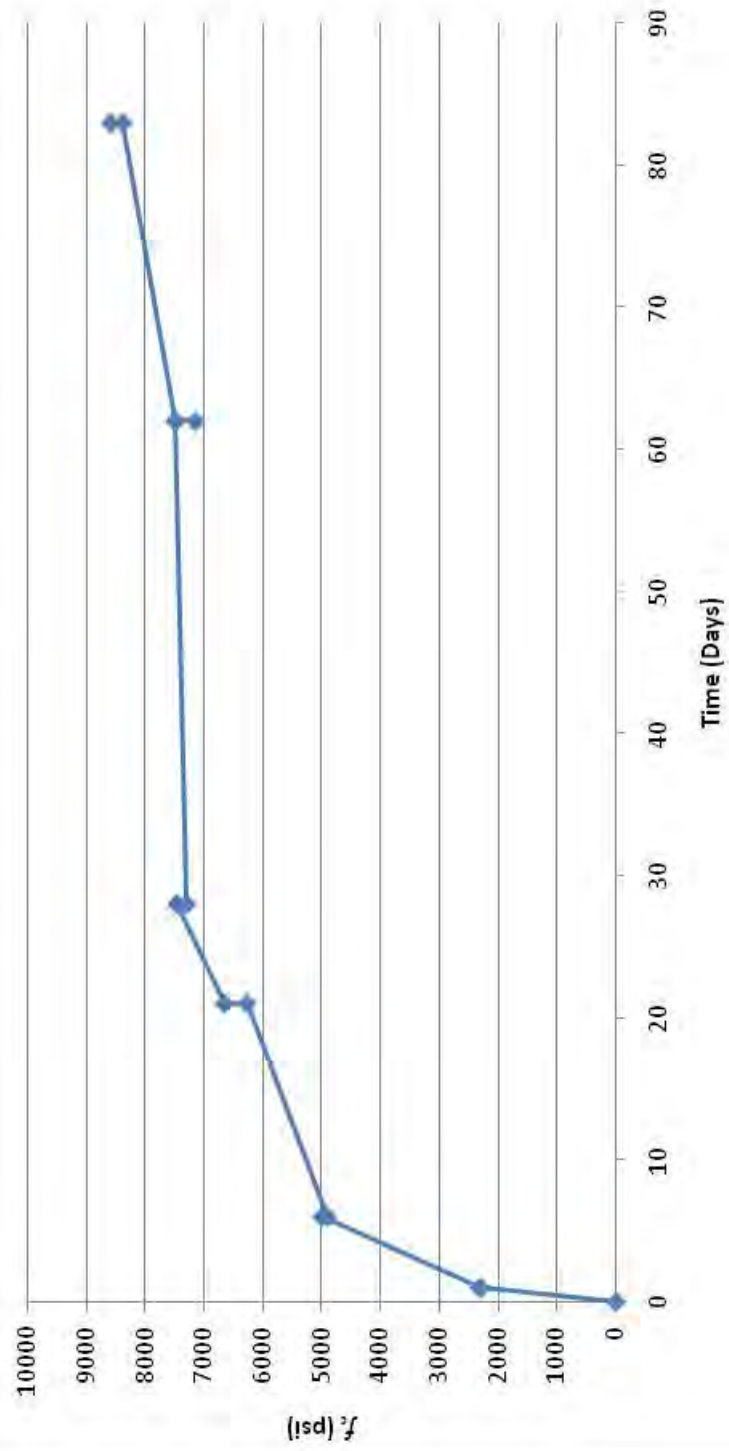



**STATE of NEW HAMPSHIRE DEPARTMENT of TRANSPORTATION  
BUREAU of MATERIALS and RESEARCH**

---

**Project:** U.N.H.DECKPANEL  
**Federal#:**

**State#:**  
**Report to:** Charlie Goodspeed

---

**Permeability of Concrete** AA40448

**Cylinder#:** 1      **Submitted by:** CHRIS ROBERT/22/2009

**Source:** On Site

**Material:** SCC      **Quantity** Batch

**Purpose:** Deck Panel Research

**Date Cast:** 1/15/2009

**% Air** 3.0      **Slump(in):** 24 in      **Mix Temp (F):**      **Air Temp (F):**

<i>Analysis</i>	<i>Result</i>	<i>Min</i>	<i>Max</i>	<i>Violation</i>	<i>Method</i>
-----------------	---------------	------------	------------	------------------	---------------

Date of Placement	01/15/09				
-------------------	----------	--	--	--	--

Date Tested	03/12/09				
-------------	----------	--	--	--	--

Age (days)	56				
------------	----	--	--	--	--

Coulombs	3646	100	4000		
----------	------	-----	------	--	--

Tested By:	DF				
------------	----	--	--	--	--

**Remarks:**

**Comments:**

**Analysis Validated by:** JA      **Date:** 3/16/2009

**Sample Validated by:** DB      **Date:** 3/19/2009

---

Thursday, March 19, 2009

## Splitting Tension Test

According to ASTM C496-04:

$$T = \frac{2P}{\pi ld}$$

Cylinder #	<i>l</i>	<i>d</i>	P	T
	(inches)	(inches)	(lbs)	(psi)
<b>1</b>	3.875	4.00	14,860	591
<b>2</b>	4.00	4.00	14,985	615

$$T = 603 \text{ psi}$$

## Elastic Modulus Determination of Test Panel SCC

$$w_c = 146.0 \frac{lb}{ft^3}$$

$$f'_c = 8584 \text{ psi}$$

**According to ACI 318, 8.5.1:**

$$E_c = w_c^{1.5} * 33\sqrt{f'_c}$$

$$E_c = (146.0 \frac{lb}{ft^3})^{1.5} * 33\sqrt{8584 \text{ psi}}$$

$$E_c = 5,394 \text{ ksi}$$

For normal weight concrete,

$$E_c = 57,000\sqrt{f'_c}$$

$$E_c = 57,000\sqrt{8584 \text{ psi}}$$

$$E_c = 5,281 \text{ ksi}$$

**According to ASTM C-469:**

$$E_c = 4,265 \text{ ksi}$$

# Elastic Modulus Determination via ASTM C-459M

$f_c = 8,584 \text{ psi}$

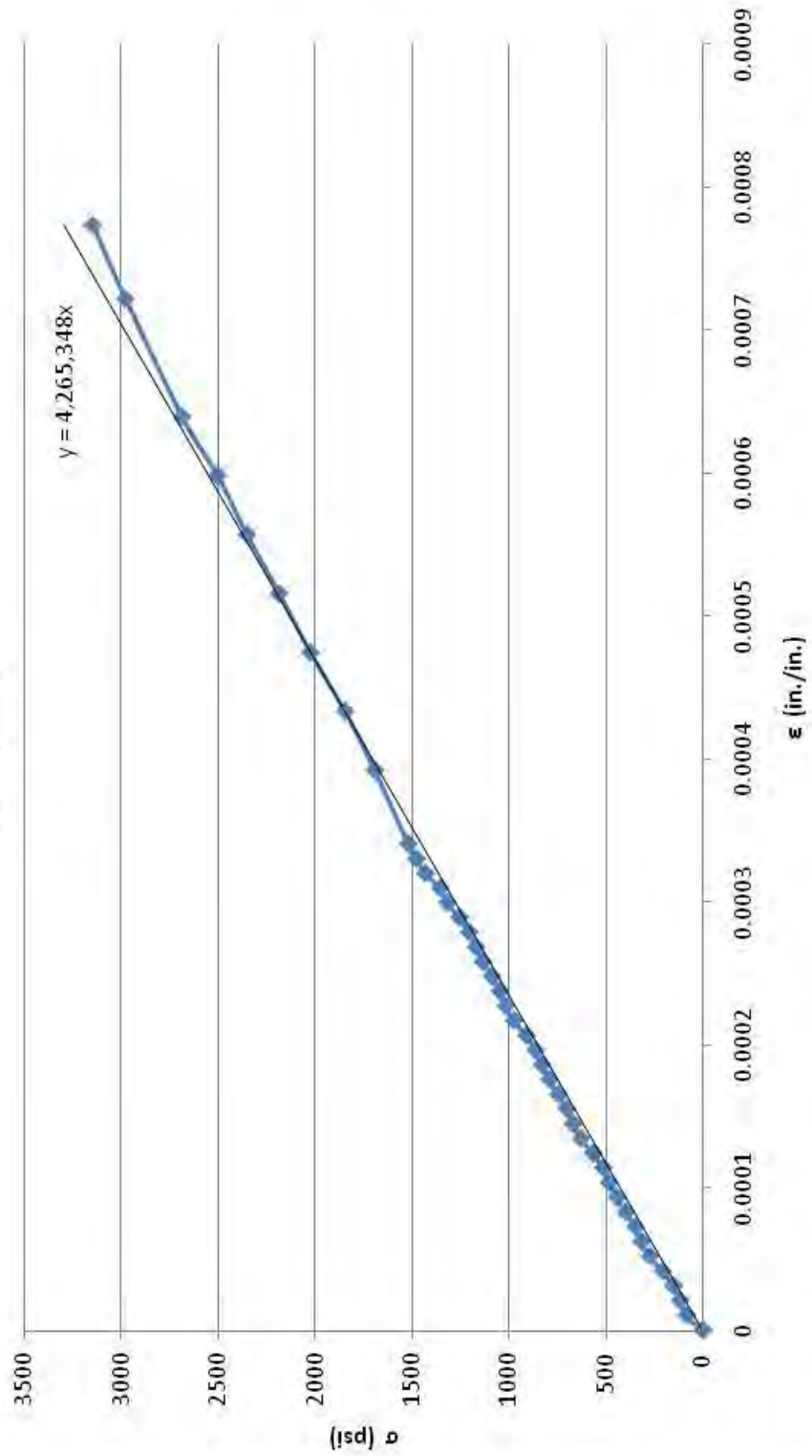

# APPENDIX D – TENSIONING DATA SHEETS

# DSI POST PRODUCT

## Prestressing Bar Properties

Nominal Bar Diameter (in.) (mm)	Ultimate Stress $f_{pu}$ (ksi) (Mpa)	Cross Section Area $A_{ps}$ (in. <sup>2</sup> ) (mm <sup>2</sup> )	Ultimate Strength $f_{pu} A_{ps}$ (kips) (kN)	Prestressing Force			Weight (lbs./ft.) (kg/m)	Minimum* Elastic Bending Radius (ft.) (m)	Maximum Bar Diameter (in.) (mm)
				0.8 $f_{pu} A_{ps}$	0.7 $f_{pu} A_{ps}$ (kips)(kN)	0.6 $f_{pu} A_{ps}$			
1 in.	150	0.85	127.5	89.3	76.5	3.01	52	1.20	
26 mm	1,030	548	567	397	340	4.48	15.9	30.5	
1 1/4 in.	150	1.25	187.5	131.3	112.5	4.39	64	1.46	
32 mm	1,030	806	834	584	500	6.54	19.5	37.1	
1 3/8 in.	150	1.58	237.0	165.9	142.2	5.56	72	1.63	
36 mm	1,030	1,018	1,055	738	633	8.28	22.0	41.4	
1 3/4 in.	150	2.62	400	280	240	9.23	92	2.00	
46 mm	1,030	1,690	1,779	1,245	1,068	13.74	28.0	51.0	
2 1/8 in.	150	5.2	780	546	461.8	17.71	-	2.71	
65 mm	1,030	3,355	3,471	2,429	2,082	26.29	-	68.9	

\* Prebent bars are required for radii less than the minimum elastic radius

\*\* Grade 160 bar may be available on special request



## THREADBAR® Accessory Dimensions

### Anchorage Details

Bar Diameter	1"	26 mm	1-1/4"	32 mm	1-3/8"	36 mm	1-3/4"	46 mm
Anchor Plate Size*	5 x 5 x 1 1/4	127 x 140 x 32	6 x 7 x 1 1/2	152 x 178 x 38	7 x 7 1/2 x 1 3/4	178 x 191 x 44	9 x 9 x 2	230 x 230 x 57
Anchor Plate Size*	4 x 6 1/2 x 1 1/4	102 x 165 x 32	5 x 8 x 1 1/2	127 x 203 x 38	5 x 9 1/2 x 1 3/4	127 x 241 x 44	-	-
Nut Extension a	1-7/8	48	2 1/2	64	2 3/4	70	2 7/8	74
Min. Bar Protrusion **B	3	76	3 1/2	89	4	102	3 5/8	92

\*other plate sizes available on special order. \*\*To accommodate stressing

### Coupler Details

#### Length C

For plain bars	6 1/4	159	6 3/4	171	8 3/4	219	6 3/4	171
For epoxy coated bars	7 3/4	197	8 1/4	210	10 1/8	267	8 3/4	222
Diameter d	2	51	2 3/8	60	2 3/4	67	3 1/8	79

#### Duct Details (galvanized steel)

Bar Duct O.D.	1 7/8	47	2	51	2 1/8	55	2 3/4	70
Bar Duct I.D.	1 5/8	43	1 7/8	48	2	51	2 5/8	67
Coupler Duct O.D.	2 3/4	70	3	76	3 1/2	87	4	101
Coupler Duct I.D.	2 5/8	67	2 7/8	72	3 1/4	83	3 3/4	95

#### Duct Details (plastic duct)

Bar duct OD	2 7/8	73	2 7/8	73	2 7/8	73	2 7/8	73
Bar duct ID	2 9/32	63	2 9/32	63	2 9/32	63	2 9/32	63
Coupler duct OD	2 7/8	73	3 9/16	90.5	3 7/8	98.4	4 17/32	115
Coupler duct ID	2 9/32	63	3	76	3 1/4	82.5	3 5/16	100

### Pocket Former Details

Depth	7 1/8	178	8	203	8 5/8	219	N/A	N/A
Maximum Diameter	5 1/8	130	6 1/2	165	6 1/2	165	N/A	N/A

**DYWIDAG SYSTEMS INTERNATIONAL, INC.  
CALIBRATION FORM**



**GAUGE**

**GAUGE TYPE:** McDaniel

**CAL ID:** 9380

**GAUGE I.D.#:** 6-20793

**DATE:** 2/5/2009

**Special Note:**

**TEMP:** 70

MASTER	TEST RUN 1	TEST RUN 2	TEST RUN 3	AVG. READING
0	0	0	0	0
1000	1000	1000	1000	1000
2000	2000	2000	2000	2000
3000	3000	3000	3000	3000
4000	4000	4000	4000	4000
5000	5000	5000	5000	5000
6000	6000	6000	6000	6000
7000	7000	7000	7000	7000
8000	8000	8000	8000	8000
9000	9000	9000	9000	9000

**CALIBRATED BY:** Donald, Blottiaux

**CUSTOMER:** University of New Hampshire

**JOB NUMBER:** j047986

**MASTER INSTRUMENT ID No.:** 91550

**TRACE # :** 9201-EQ

**DESCRIPTION :** Load Measuring

**ALTHOUGH RAM/GAUGE COMBINATIONS ARE CALIBRATED AS A UNIT, GAUGES ARE CALIBRATED INDEPENDENTLY, AND ARE USABLE ON OTHER DYWIDAG SYSTEM RAMS, WHEN THIS DOES NOT CONFLICT WITH PROJECT SPECIFICATIONS.**

**INSTRUCTIONS:**

1. Each gauge must be calibrated to a master instrument that has been calibrated and traceable to NIST Standards.
2. Each gauge must be calibrated to meet or exceed ASME STD. 40.1.
3. Each gauge will be calibrated before being used in a jack calibration.
4. Each gauge will be calibrated before being sent to the customer as a replacement gauge.
5. Connect the gauge to the testing machine.
6. Pressurize the gauge in 10 increments throughout it's entire range, 3 times.
7. Record the gauge and test standard readings.
8. If gauge is in need of adjustment, consult the manufacturers product manual contained in the DSI equipment calibration and standards book.
9. Form is to be used by Equipment Dept. staff in the calibration of hydraulic gauges that will be used by the customer.
10. Form is to be completely filled out.
11. Form is to be filled in the gauge calibration file according to it's I.D. No. and with any associated equipment file. One Copy to customer.

DYWIDAG SYSTEMS INTERNATIONAL, INC.



**JACK CALIBRATION FORM**

CALIBRATION ID  
8545

JACK TYPE: 60Mp SERIES 04  
JACK ID: A46

THEO. RAM AREA: 20.50  
COMPUTED RAM AREA: 20.54

DATE: 2/5/2009

PRESSURE GAUGES: MASTER GAUGE CALIBRATION STANDARD: ANSI 45.2  
MASTER GAUGE: 466 SERVICE GAUGE CALIBRATION STANDARD: ANSI 40.1  
SERVICE GAUGE(S): GAUGE 1: 6-20793 GAUGE 2: GAUGE3: GAUGE 4:

LOADCELL: CALIBRATION STANDARD: ASTM E4 AND E74  
TYPE: EVERGREEN I.D. NO. 101  
METER NUMBER: 1211  
METER MFG: EVERGREEN WEIGHT CONVERSION EQUATION:  $AVG. X \quad 1 \quad + \quad 0$

Temperature: 70 Humidity: 40%

Calibration Location: DYWIDAG SYSTEMS INTERNATIONAL, INC.

Calibrated By: Don Blottiaux

Calibration Firm: DYWIDAG SYSTEMS INTERNATIONAL, INC.

Verified By: Greg Wilkinson

Verification Firm: DYWIDAG SYSTEMS INTERNATIONAL, INC.

Customer: University of New Hampshire

Job Number: j047986

MASTER	GAUGE 1	GAUGE 2	GAUGE 3	GAUGE 4	RUN 1	RUN 2	RUN 3	AVG	ACT KIPS
1000	1000	0	0	0	21.13	21.03	21.05	21.070	21.070
2000	2000	0	0	0	41.39	41.29	41.26	41.313	41.313
3000	3000	0	0	0	62.09	62.11	62.44	62.213	62.213
4000	4000	0	0	0	82.68	83.15	83.01	82.947	82.947
5000	5000	0	0	0	103.38	102.93	103.12	103.143	103.143
5500	5500	0	0	0	113.48	113.91	113.62	113.670	113.670
6000	6000	0	0	0	123.46	123.67	123.44	123.523	123.523
6500	6500	0	0	0	134.11	133.86	134.01	133.993	133.993
7000	7000	0	0	0	143.64	143.52	143.54	143.567	143.567
7400	7400	0	0	0	151.84	152.21	151.94	151.997	151.997

For Monostrand Use Only Please Refer To; Use Gauge PSI

True Gauge PSI: N/A N/A = 80% of U.T.S Use Gauge PSI: N/A

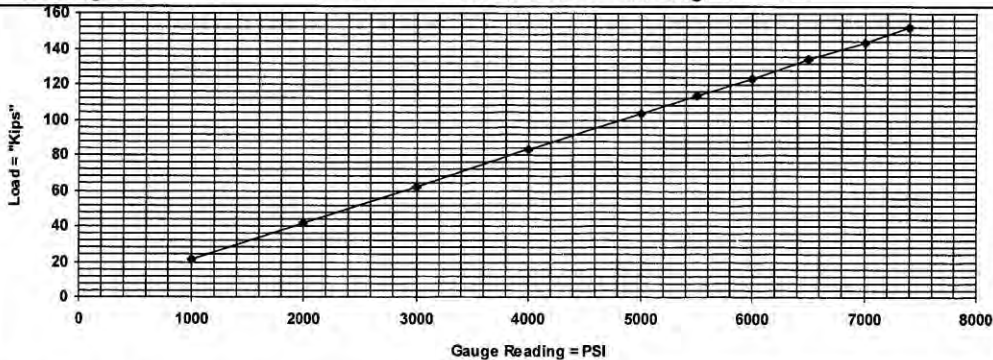

Report Created By: Russell Galasinski

Report Number: 11-3-EDTS-R3 Revised Date: 4-8-00

# APPENDIX E – TRANSVERSE JOINT MATERIAL PRODUCT DATA SHEETS

Construction

Product Data Sheet  
Edition 7.1.2008  
Identification no. 399  
Sikadur 31, SBA Slow-Set

## Sikadur® 31, SBA Slow-Set

### Segmental Bridge Adhesive

High-modulus, high-strength, moisture tolerant, epoxy paste adhesive

<b>Description</b>	Sikadur 31, SBA Slow-Set is a unique high-modulus 2-component, moisture-tolerant, solvent-free, epoxy-resin system available in three application temperature ranges. A unique high-modulus, structural adhesive for bonding hardened concrete to hardened concrete for segmental bridge construction. The mixed material has the consistency of paste and is a concrete gray color. It conforms to the current ASTM C-881, Type VII requirements, and ASBI guidelines.
<b>Where to Use</b>	<ul style="list-style-type: none"> <li>■ Structural bonding of post-tensioned precast concrete bridge segments.</li> <li>■ Sealing joints between concrete segments.</li> <li>■ Slow-set version for span-by-span erection.</li> <li>■ Supplied in three temperature grades to meet project requirements.</li> </ul>
<b>Advantages</b>	<ul style="list-style-type: none"> <li>■ Moisture tolerant before, during and after cure.</li> <li>■ High-modulus, high-strength, structural paste adhesive.</li> <li>■ Range of curing times to meet assembly and strength gain requirements.</li> <li>■ Easy to apply, non-sag paste for vertical applications.</li> <li>■ Excellent adhesion to concrete, steel and most construction materials.</li> <li>■ Convenient easy to mix ratios.</li> <li>■ Color-coded components to ensure proper mixing control.</li> </ul>
<b>Coverage</b>	Approximately 12 sq. ft./gal. or 36 sq. ft./3 gal. unit.
<b>Packaging</b>	3 gal. units.

#### Typical Data (Material and curing conditions @ 73°F (23°C) and 50% R.H.)

<b>Shelf Life</b>	2 years in original, unopened containers.	
<b>Storage Conditions</b>	Store dry at 40°-95°F (4°-35°C). Condition material to 70°-75°F (21°-24°C) before using.	
<b>Color</b>	Concrete gray.	
<b>Consistency</b>	Non-sag paste.	
<b>Product Name</b>	<b>Temp. Range</b>	<b>Mix Ratio, A:B by Volume</b>
Slow Set (40°-61°F)	40°-61°F (4°-16°C)	2:1
Slow Set (55°-75°F)	55°-75°F (13°-24°C)	2:1
Slow Set (70°-90°F)	70°-90°F (21°-32°C)	2:1

Property	SBA SS 40°-61°F	SBA SS 55°-75°F	SBA SS 70°-90°F
Pot life, 1 gallon	2 hours	2 hours	2 hours
Compressive Strength	2000	4000	8500
36 hr., psi	7000	7000	9500
72 hr., psi			
Open Time			
Contact strength after open time, 14 day, psi	8 hours - 2100	8 hours - 2250	8 hours - 2250
Bond strength, 14 day, psi	2000	2200	3000
Heat deflection Temp., °F	122	124	124



C300



**How to Use**

<b>Surface Preparation</b>	Surface must be clean and sound. It may be dry or damp, but free of standing water and frost. Remove dust, laitance, grease, curing compounds, impregnations, waxes, foreign particles, disintegrated materials and any other contaminants.
<b>Mixing</b>	Pre-mix each component. Wear chemical resistant gloves and safety goggles. Mix all of Part 'A' with all of Part 'B'. Mix thoroughly for a minimum of 3 minutes with a low-speed (400-600 rpm) drill fitted with a mixing Sika paddle until a uniform gray color is achieved. Scrape down the sides of the mixing pail and ensure there are no streaks of unmixed epoxy before applying. Mix only that quantity which can be used within its pot life.
<b>Application</b>	Apply the neat mixed Sikadur 31, SBA Slow-Set to the concrete surface using a trowel, spatula, or glove protected hand; work into surface especially if it is damp. Spread to a thickness of 1/8" (3 mm) to one face or 1/16" (1.5 mm) on both faces, depending upon project requirements. Segments must be post-tensioned within the open time of the epoxy.
<b>Limitations</b>	<ul style="list-style-type: none"> <li>■ Do not thin Sikadur 31, SBA Slow-Set. Solvents will prevent proper cure.</li> <li>■ Use correct temperature range material for prevailing conditions.</li> <li>■ Use correct setting material (normal or slow) depending upon method of erection.</li> <li>■ Not for use as an adhesive for fresh, plastic, portland cement concrete or mortar.</li> <li>■ Lower temperatures will prolong cure time. Higher temperatures will rapidly accelerate cure time.</li> <li>■ Use of product outside of designated temperature range is not recommended.</li> <li>■ Not an aesthetic product. Color may alter due to variations in lighting and/or UV exposure.</li> </ul>
<b>Caution</b>	<p><b>Component 'A' - Irritant, Sensitizer:</b> Eye/skin/respiratory irritant. Possible sensitization. Allergic reaction possible with prolonged exposure.</p> <p><b>Component 'B' - Irritant, Sensitizer:</b> Contains amines. Contact with skin and eyes can cause severe burns. Respiratory irritant. Possible sensitization/allergic reaction with prolonged exposure. High concentrations of vapor may cause respiratory irritation. If product is sanded or abraded after curing, crystalline silica dust can be inhaled and cause delayed lung injury (silicosis). Harmful if swallowed.</p> <p>Slow Set 55-75F contains nonylphenol. Chronic overexposure to nonylphenol may cause liver injury based on animal studies.</p> <p><b>WARNING: THIS PRODUCT CONTAINS A CHEMICAL KNOWN TO THE STATE OF CALIFORNIA TO CAUSE CANCER.</b></p> <p>Deliberate concentration of vapors for inhalation is harmful and may prove fatal.</p>
<b>First Aid</b>	<p><b>Eyes:</b> Hold eyelids apart and flush thoroughly with water for 15 minutes. <b>Skin:</b> Remove contaminated clothing. Wash skin thoroughly for 15 minutes with soap and water. <b>Inhalation:</b> Remove person to fresh air. <b>Ingestion:</b> Do not induce vomiting. In all cases, contact a physician immediately if symptoms persist.</p>
<b>Handling and Storage</b>	Avoid direct contact. Wear protective equipment, chemical resistant gloves, goggles, and clothing to prevent direct contact with skin and eyes. Use with adequate general and local ventilation. In absence of adequate ventilation use properly fitted NIOSH respirator. Wash thoroughly after handling product. Remove contaminated clothing and launder before reuse. Store product in closed container in cool dry place.
<b>Clean Up</b>	(Material Spills). Ventilate area. Confine spill. Collect with absorbent material, flush area with water. Dispose of in accordance with current, applicable local, state, and federal regulations. Uncured material can be removed with approved solvent. Follow solvent manufacturer's instructions for use and warnings. Cured material (when combined with component 'B') can only be removed mechanically.

KEEP CONTAINER TIGHTLY CLOSED - KEEP OUT OF REACH OF CHILDREN - NOT FOR INTERNAL CONSUMPTION - FOR INDUSTRIAL USE ONLY

All information provided by Sika Corporation ("Sika") concerning Sika products, including but not limited to, any recommendations and advice relating to the application and use of Sika products, is given in good faith based on Sika's current experience and knowledge of its products when properly stored, handled and applied under normal conditions in accordance with Sika's instructions. In practice, the differences in materials, substrates, storage and handling conditions, actual site conditions and other factors outside of Sika's control are such that Sika assumes no liability for the provision of such information, advice, recommendations or instructions related to its products, nor shall any legal relationship be created by or arise from the provision of such information, advice, recommendations or instructions related to its products. The user of the Sika product(s) must test the product(s) for suitability for the intended application and purpose before proceeding with the full application of the product(s). Sika reserves the right to change the properties of its products without notice. All sales of Sika product(s) are subject to its current terms and conditions of sale which are available at [www.sikacoip.com](http://www.sikacoip.com) or by calling 800-933-7452.

Prior to each use of any Sika product, the user must always read and follow the warnings and instructions on the product's most current Technical Data Sheet, product label and Material Safety Data Sheet which are available online at [www.sikaconstruction.com](http://www.sikaconstruction.com) or by calling Sika's Technical Service Department at 800-933-7452. Nothing contained in any Sika materials relieves the user of the obligation to read and follow the warnings and instruction for each Sika product as set forth in the current Technical Data Sheet, product label and Material Safety Data Sheet prior to product use.

**LIMITED WARRANTY:** Sika warrants this product for one year from date of installation to be free from manufacturing defects and to meet the technical properties on the current Technical Data Sheet if used as directed within shelf life. User determines suitability of product for intended use and assumes all risks. Buyer's sole remedy shall be limited to the purchase price or replacement of product exclusive of labor or cost of labor. **NO OTHER WARRANTIES EXPRESS OR IMPLIED SHALL APPLY INCLUDING ANY WARRANTY OF MERCHANTABILITY OR FITNESS FOR A PARTICULAR PURPOSE. SIKASHALL NOT BE LIABLE UNDER ANY LEGAL THEORY FOR SPECIAL OR CONSEQUENTIAL DAMAGES. SIKASHALL NOT BE RESPONSIBLE FOR THE USE OF THIS PRODUCT IN A MANNER TO INFRINGE ON ANY PATENT OR ANY OTHER INTELLECTUAL PROPERTY RIGHTS HELD BY OTHERS.**

Visit our website at [www.sikaconstruction.com](http://www.sikaconstruction.com) 1-800-933-SIKA NATIONWIDE

Regional Information and Sales Centers. For the location of your nearest Sika sales office, contact your regional center.

**Sika Corporation**  
201 Polito Avenue  
Lyndhurst, NJ 07071  
Phone: 800-933-7452  
Fax: 201-933-6225

**Sika Canada Inc.**  
601 Delmar Avenue  
Pointe Claire  
Quebec H9R 4A9  
Phone: 514-697-2610  
Fax: 514-694-2792

**Sika Mexicana S.A. de C.V.**  
Carretera Libre Celaya Km. 8.5  
Fracc. Industrial Balvanera  
Corregidora, Queretaro  
C. P. 76920  
Phone: 52 442 2385600  
Fax: 52 442 2250537



ISO 9001:2008  
Sika and Sikadur are registered trademarks.  
Made in USA. Printed in Canada.



**Product Data Sheet**  
Edition 6.2003  
Identification no. 525-501  
SikaGrout 212

## SikaGrout® 212

### High performance, cementitious grout

<b>Description</b>	SikaGrout 212 is a non-shrink, cementitious grout with a unique 2-stage shrinkage compensating mechanism. It is non-metallic and contains no chloride.  With a special blend of shrinkage-reducing and plasticizing/water-reducing agents, SikaGrout 212 compensates for shrinkage in both the plastic and hardened states. A structural grout, SikaGrout 212 provides the advantage of multiple fluidity with a single component. SikaGrout 212 meets Corps of Engineers' Specification CRD C-621 and ASTM C-1107 (Grade C).
<b>Where to Use</b>	<ul style="list-style-type: none"> <li>■ Use for structural grouting of column base plates, machine base plates, anchor rods, bearing plates, etc.</li> <li>■ Use on grade, above and below grade, indoors and out.</li> <li>■ Multiple fluidity allows ease of placement: ram in place as a dry pack, trowel-apply as a medium flow, pour or pump as high flow.</li> </ul>
<b>Advantages</b>	<ul style="list-style-type: none"> <li>■ Easy to use... just add water.</li> <li>■ Multiple fluidity with one material.</li> <li>■ Non-metallic, will not stain or rust.</li> <li>■ Low bleed.</li> <li>■ Low heat build-up.</li> <li>■ Excellent for pumping: Does not segregate... even at high flow. No build-up on equipment hopper.</li> <li>■ Non-corrosive, does not contain chlorides.</li> <li>■ Superior freeze/thaw resistance.</li> <li>■ Resistant to oil and water.</li> <li>■ Meets CRD C-621.</li> <li>■ Meets ASTM C-1107 (Grade C).</li> <li>■ Shows positive expansion when tested in accordance with ASTM C-827.</li> <li>■ SikaGrout 212 is USDA-approved.</li> </ul>
<b>Coverage</b>	Approximately 0.44 cu. ft./bag at high flow.
<b>Packaging</b>	6 lb. pail, 6/case, 36/pallet; 50-lb. multi-wall bags; 36 bags/pallet.

Typical Data (Material and curing conditions @ 73°F (23°C) and 50% R.H.)			
<b>Shelf Life</b>	One year in original, unopened bags.		
<b>Storage Conditions</b>	Store dry at 40°-95°F (4°-35°C). <b>Condition material to 65°-75°F before using.</b>		
<b>Color</b>	Concrete gray		
<b>Flow Conditions</b>	<b>Plastic<sup>1</sup></b>	<b>Flowable<sup>1</sup></b>	<b>Fluid<sup>2</sup></b>
<b>Typical Water Requirements:</b>	6 pt.+	6.5 pt.	8.5 pt.
<b>Set Time (ASTM C-266):</b>	<b>Initial</b>	<b>4.0-5.0 hr.</b>	<b>4.5-6.5 hr.</b>
	<b>Final</b>	<b>4.5-5.5 hr.</b>	<b>6.0-8.0 hr.</b>
<b>Tensile Splitting Strength, psi (ASTM C-496)</b>			
28 day	600 (4.1 MPa)	575 (3.9 MPa)	500 (3.4 MPa)
<b>Flexural Strength, psi (ASTM C-293)</b>			
28 day	1,400 (9.6 MPa)	1,200 (8.2 MPa)	1,000 (6.8 MPa)
<b>Bond Strength, psi (ASTM C-882 modified): Hardened concrete to plastic grout</b>			
28 day	2,000 (13.7 MPa)	1,900 (13.1 MPa)	1,900 (13.1 MPa)
<b>Expansion % (CRD C-621)</b>	<b>28 day</b>	<b>+0.021%</b>	<b>+0.056%</b>
<b>Compressive Strength, psi (CRD C-621)</b>			
1 day	4,500 (31.0 MPa)	3,500 (24.1 MPa)	2,700 (18.6 MPa)
7 day	6,100 (42.0 MPa)	5,700 (39.3 MPa)	5,500 (37.9 MPa)
28 day	7,500 (51.7 MPa)	6,200 (42.7 MPa)	5,800 (40.0 MPa)

<sup>1</sup>CRD C-227: 100-124% (plastic), 124-145% (flowable)  
<sup>2</sup>CRD C-611: 10-30 sec efflux time



## How to Use

<b>Surface Preparation</b>	Remove all dirt, oil, grease, and other bond-inhibiting materials by mechanical means. Anchor bolts to be grouted must be de-greased with suitable solvent. Concrete must be sound and roughened to promote mechanical adhesion. Prior to pouring, surface should be brought to a saturated surface-dry condition.
<b>Forming</b>	For pourable grout, construct forms to retain grout without leakage. Forms should be lined or coated with bond-breaker for easy removal. Forms should be sufficiently high to accommodate head of grout. Where grout-tight form is difficult to achieve, use SikaGrout 212 in dry pack consistency.
<b>Mixing</b>	Mix manually or mechanically. Mechanically mix with low-speed drill (400-600 rpm) and Sika mixing paddle or in appropriately sized mortar mixer. <b>Product Extension:</b> For deeper applications, SikaGrout 212 (plastic and flowable consistencies only) may be extended with 25 lbs. of 3/8" pea gravel. The aggregate must be non-reactive, clean, well-graded, saturated surface dry, have low absorption and high density, and comply with ASTM C33 size number 8 per Table 2. Add the pea gravel after the water and SikaGrout 212.
<b>Mixing Procedure</b>	Make sure all forming, mixing, placing, and clean-up materials are on hand. Add appropriate quantity of clean water to achieve desired flow. Add bag of powder to mixing vessel. Mix to a uniform consistency, minimum of 2 minutes. Ambient and material temperature should be as close as possible to 70°F. If higher, use cold water; if colder, use warm water.
<b>Application</b>	Within 15 minutes after mixing, place grout into forms in normal manner to avoid air entrapment. Vibrate, pump, or ram grout as necessary to achieve flow or compaction. SikaGrout 212 must be confined in either the horizontal or vertical direction leaving minimum exposed surface. After grout has achieved final set, remove forms, trim or shape exposed grout shoulders to designed profile. SikaGrout 212 is an excellent grout for pumping, even at high flow. For pump recommendations, contact Technical Service. Wet cure for a minimum of 3 days or apply a curing compound which complies with ASTM C-309 on exposed surfaces.
<b>Limitations</b>	<ul style="list-style-type: none"> <li>■ Minimum ambient and substrate temperature 45°F and rising at time of application.</li> <li>■ Minimum application thickness: 1/2 in.</li> <li>■ Maximum application thickness (neat): 2 in. Deeper applications are possible, please contact Sika's technical services department.</li> <li>■ Do not use as a patching or overlay mortar or in unconfined areas.</li> <li>■ Material must be placed within 15 minutes of mixing.</li> <li>■ As with all cement based materials, avoid contact with aluminum to prevent adverse chemical reaction and possible product failure. Insulate potential areas of contact by coating aluminum bars, rails, posts etc. with an appropriate epoxy such as Sikadur Hi-Mod 32.</li> </ul>
<b>Caution Irritant</b>	Suspect carcinogen - contains portland cement and crystalline silica. Skin and eye irritant. Avoid breathing dust. Use only with adequate ventilation. May cause delayed lung injury (silicosis). IARC lists crystalline silica as having sufficient evidence of carcinogenicity in laboratory animals and limited evidence of carcinogenicity in humans. NTP also lists crystalline silica as a suspect carcinogen. Use of safety goggles and chemical resistant gloves is recommended. In case of high dust concentrations or exceedance of PELs, use an appropriate NIOSH approved respirator. Remove contaminated clothing.
<b>First Aid</b>	In case of skin contact, wash thoroughly with soap and water. For eye contact, flush immediately with plenty of water for at least 15 minutes; contact physician immediately. Wash clothing before re-use.
<b>Clean Up</b>	In case of spillage, ventilate area of spill, confine spill, vacuum or scoop into appropriate container. Dispose of in accordance with current applicable local, state and federal regulations. Uncured material can be removed with water. Cured material can only be removed mechanically.

KEEP CONTAINER TIGHTLY CLOSED NOT FOR INTERNAL CONSUMPTION CONSULT MATERIAL SAFETY DATA SHEET FOR MORE INFORMATION

Sika warrants this product for one year from date of installation to be free from manufacturing defects and to meet the technical properties on the current technical data sheet if used as directed within shelflife. User determines suitability of product for intended use and assumes all risks. Buyer's sole remedy shall be limited to the purchase price or replacement of product exclusive of labor or cost of labor.

NO OTHER WARRANTIES EXPRESS OR IMPLIED SHALL APPLY INCLUDING ANY WARRANTY OF MERCHANTABILITY OR FITNESS FOR A PARTICULAR PURPOSE. SIKA SHALL NOT BE LIABLE UNDER ANY LEGAL THEORY FOR SPECIAL OR CONSEQUENTIAL DAMAGES.

Visit our website at [www.sikausa.com](http://www.sikausa.com) 1-800-933-SIKA NATIONWIDE

Regional Information and Sales Centers. For the location of your nearest Sika sales office, contact your regional center.

Sika Corporation  
201 Polito Avenue  
Lyndhurst, NJ 07071  
Phone: 800-933-7462  
Fax: 201-933-6225

Sika Canada Inc.  
601 Delmar Avenue  
Pointe Claire  
Quebec H9R 4A9  
Phone: 514-897-2610  
Fax: 514-694-2792

Sika Mexicana S.A. de C.V.  
Carretera Libre Celaya Km. 8.5  
Corregidora, Queretaro  
C.P. 76920 A.P. 136  
Phone: 52 42 25 0122  
Fax: 52 42 25 0537



Sika and SikaGrout are registered trademarks. Made in USA. Printed in USA.



# APPENDIX F – PROPRIETARY FORM MATERIAL PRODUCT DATA SHEETS

H & F MANUFACTURING CORP. 800.474.2732 www.hfmfgcorp.com

## Phase-2 PVC

Industrial/Commercial Siding, Roofing, and Louver Panels



### Phase-2 PVC Corrugated Siding, Roofing, and Louver Panels Are Unquestionably The Most Versatile and Widely Used



Phase-2 PVC Siding, Roofing, and Louver Panels are solid, heavy gauge Polyvinyl Chloride (PVC) extruded sheets that **maintain color and structural integrity** under the toughest weather conditions and physical abuse. Phase-2 PVC is **Factory Mutual Approved** for unlimited height use, without the need for sprinkler protection, and offers a **Non-Combustible Flame Spread Rating of 12**. Phase-2 PVC also performs exceptionally in **resisting most corrosive conditions** from many organic and inorganic chemical fumes and liquids. Phase-2 PVC is completely **UV resistant** and **will not yellow or discolor**, and will block out harmful UV radiation.

#### Industries and Applications:



Industrial



Light Industrial



Chemical



Commercial

#### Other Industries:

- Coal and metal mining
- Food manufacturing
- Government
- Petroleum
- Power plants
- Transportation
- Waste water treatment
- And many more

#### Other Applications:

- Canopies
- Cooling tower louvers and casing
- Elevator enclosures
- Barriers and partitions
- Lean-to's
- Salt storage facilities
- Skylights, awnings, translucent roofing
- Storage facilities

H & F MANUFACTURING CORP.  
PO Box 85  
Feasterville, PA 19053-0085

800.474.2732  
215.355.0250  
Fax: 215.355.4066  
Email: info@hfmfgcorp.com  
www.hfmfgcorp.com

**Features:**

- Widest range of resistance to corrosion
- Low non-combustible flame spread rating of 12
- High UV resistance: will not yellow, discolor, or turn brittle
- High impact strength
- Factory Mutual approved
- Solid PVC, no peeling, denting or loss of structural integrity
- Easy to handle and install
- Operating temperature range -50° F to 150° F

**Cooling Towers:**

Phase-2 PVC Louver and Casing panels are furnished in a maximum size of 47-7/8" wide and 38' long, while incremental or partial sizes of louvers and casing panels are easily cut-to-order at our plant in Ivyland, PA and shipped from there on the shortest possible notice. They are easily cut at the site of the cooling tower, construction or repair and are easily installed without risk of breaking, cracking, chipping or other possible effects due to rough handling or inclement weather.



**PHASE-2 PVC CORRUGATED AND FLAT PANELS**

Profile	Configuration Detail	Width	Lengths Up To	Thickness	Colors	Oz./Ft. <sup>2</sup>	Conforms To
4.2" x 1-1/16"		42"	38'	3/32" 1/8" 3/16"	White, Gray White, Gray, Clear, Tan, Blue White, Gray	12 16 24	FRP, Asbestos Cement
2.67" x 7/8"		40"	38'	3/32"	White, Gray, Clear	12	FRP, Steel, Aluminum
ASTORIA Box Rib Embossed Surface		40-1/4"	38'	3/32"	White, Tan	12	Proprietary Configuration
7.2" x 1-1/2"		47-7/8"	38'	1/8"	White, Gray, Clear	16	FRP, Steel, Aluminum
AG-TUF Greca Rib		26" or 38"	specific lengths to 20'4"	1/32"	White	4	Box Rib
AG-TUF UV 9' Classic Rib		38"	specific lengths to 20'4"	1mm	White, Tan	5	FRP, Steel, Aluminum
Flat UV Type 1, Type 2		4' x 8' Standard		1/16", 1/8" 1/8", 3/16", 1/4", 1/2"	White, Gray, Clear, Tan, Blue White, Dark Gray	8, 16 16, 24, 32, 48	
Flat Astoria Embossed		4' x 8' Standard		3/32"	White, Tan	12	

*Non-standard colors and sizes for all profiles and product lines available upon request.*

## Table of Physical and Structural Properties

### Mechanical Properties

Tensile Strength .....	.8000 psi
Flexural Modulus .....	.425000 psi
Flexural Strength .....	.13000 psi
Compressive Strength .....	.11000 psi
Impact Strength (Izod) 68°F .....	.6.0 ft-lb/in
Impact Strength (Izod) 32°F .....	.0.5 ft-lb/in
Elongation .....	.65%

### Thermal Properties

Thermal Conductivity .....	.4.2 x 10 <sup>-4</sup> cal/sec/cm <sup>2</sup> /(°C/cm)
Coefficient of Expansion .....	.3.5 x 10 <sup>-5</sup> in/in/°F
.....	.6.3 x 10 <sup>-5</sup> in/in/°C
K - Factor .....	.10 <sup>16</sup> W/m <sup>2</sup> °C
Specific Heat .....	.3 cal/°C/gm

### Electrical Properties

Volume Resistivity .....	.10 <sup>16</sup> ohm-cm (50% RH + 23°C)
Dielectric Strength .....	.350 - 500 volts/mil
Dielectric Constant .....	.3.6 KHz

## Approvals and Certifications

- Phase-2 PVC Panels are non-combustible, i.e., they will not support combustion, and have a Flame Spread Rating of 12 (Class 1-Non-Combustible Material of Construction).
- Phase-2 PVC Panels were subjected to the Factory Mutual Wind Uplift Pressure Test (FMRC Standard 4470) and were approved as a Roofing Panel. Phase-2 PVC Panels met the minimum 60 psf FMRC requirement for Class I-60 Windstorm Classification and the 90 psf FMRC requirement for Class I-90 Windstorm Classification.
- Phase-2 PVC Panels have satisfactorily passed the FMRC Simulated Hail Damage Test using the FMRC Class I-MH Simulated Hail Damage Test apparatus.
- Phase-2 PVC Panels with their light colors reflect heat and result in lower "skin" temperatures assuring their proper performance up to 150°F.
- Phase-2 PVC Panels offer excellent resistance against water and a very broad range of chemicals in the forms of solids, liquids, or fumes. (See Chemical Resistance Page.)
- Phase-2 PVC Panels have extremely high impact strength (6 ft. lbs/in Izod), which means that the panels are highly breakage resistant and will not dent due to impact, over the entire temperature range for which these panels are recommended.

The above Applications and Certifications do not pertain to AG-TUF, AG-TUF UV or Palight.



**PHASE-2 PVC PANELS  
APPROVAL  
as  
CLASS 1 CONSTRUCTION MATERIAL  
for Unlimited Height Use  
Without Sprinkler Protection**

Phase-2 PVC Panels are homogeneous non-reinforced RIGID PVC (Polyvinyl Chloride) sheets in thicknesses from 3/32" to 3/16" and available in various configurations produced by H & F Manufacturing Corporation.

Phase-2 PVC Siding and Roofing Panels have been tested by Factory Mutual Research Corporation under Standard 4880 and have been approved for **unlimited height use** in non-load bearing walls and structures as a **CLASS 1 CONSTRUCTION WALL AND CEILING PANEL** not requiring automatic sprinkler protection, (i.e., material must not produce self-propagating fire to the limits of the structure as evidenced by flaming or material damage, and also must not ignite).

Factory Mutual Approval Index Listing No. **JJ. IV4AO.AM** August 3, 1992.

**Specifications**

1. Panels shall be Phase-2 PVC manufactured by H & F Manufacturing Corporation, PO Box 85, Feasterville, PA 19053-0085. Phone: 800.474.2732 Local: 215.355.0250 Fax: 215.355.4066, Email: info@hfmfgcorp.com www.hfmfgcorp.com.
2. PVC Resin content shall not be less than 80% by weight.
3. Nominal thickness shall be 3/32", 1/8", or 3/16". The nominal weight shall be 12, 16, or 24 ounces per square foot respectively, and the corrugation configuration shall be 2.67" x 7/8", 4.2" x 1-1/16", 7.2" x 1-1/2" or ASTORIA box rib.
4. Panels shall have a Class 1 non-combustible flame spread rating of 12 or less.
5. Approval under Factory Mutual Research Corp. Std. 4470, 4471, and 4880.
  - PHASE-2 PVC Panels are approved for unlimited height use in non-load bearing walls and structures as a Class 1 Construction Material not requiring sprinkler protection.
  - PHASE-2 PVC Panels are approved for both wall and roof/ceiling applications for non-combustible occupancies where sprinklers are not required. The panels in and of themselves do not require automatic sprinkler protection when installed on the roof/ceiling or walls. They also would be acceptable in a combustible occupancy when protected by automatic sprinklers as defined by FMRC Loss Prevention Standards.
  - The panel shall meet FMRC Class I-MH requirements for use outside by the Hail Hazard Boundaries contained in FMRC Data Sheet I-47S.1.
  - When installed in accordance with recommendations of H & F Manufacturing Corp., the panels shall meet the FMRC requirement for Class I-90 Windstorm Classification.
6. Color and surface finish shall be furnished by manufacturer.

The above Applications and Certifications do not pertain to AG-TUF, AG-TUF UV or Palight.

### Phase-2 PVC Chemical Resistance

For chemicals and corrosive media not found on this list, please contact your H & F representative. It is important to note that H & F PVC panels are generally not recommended for use with acetone, ketones, ethers, and aromatic and chlorinated hydrocarbons. The information on chemical resistance is based on our research and experience. It serves as a basis for recommendation.

The table on pages 5 and 6 use the following key:

R — Resistant      LR — Limited Resistance      N — Not Resistant

Chemical	Concentration %	Resistance	Chemical	Concentration %	Resistance
Aluminum Chloride	Saturated	R	Ferrous Sulfate	—	R
Aluminum Fluoride	—	R	Fluorine Gas	—	LR
Aluminum Hydroxide	—	R	Fluoroboric Acid	—	R
Aluminum Sulfate	Saturated	R	Formaldehyde	—	LR
Ammonia (Gas)	—	R	Hydrobromic Acid	20	R
Ammonia (Liquid)	—	N	Hydrochloric Acid	35	R
Ammonium Acetate	—	R	Hydrofluoric Acid	48	LR
Ammonium Bifluoride	—	R	Hydrofluoric Acid	70	LR
Ammonium Bisulfate	—	R	Hydrogen Peroxide	50	R
Ammonium Chloride	—	R	Hydrogen Sulfide	—	R
Ammonium Fluoride	25	LR	Iodine	—	N
Ammonium Hydroxide	10	R	Magnesium Carbonate	—	R
Ammonium Hydroxide	26	R	Magnesium Chloride	—	R
Ammonium Nitrate	—	R	Magnesium Hydroxide	—	R
Ammonium Sulfate	Saturated	R	Magnesium Sulfate	—	R
Ammonium Sulfide	Saturated	R	Nickel Sulfate	—	R
Antimony Trichloride	—	R	Nitric Acid	60	R
Aqua Regia (3 part HCl/1 part HNO <sub>3</sub> )	—	N	Nitrous Oxide	—	R
Arsenic Acid	80	R	Ozone	—	R
Barium Chloride	—	R	Perchloric Acid	70	LR
Barium Sulfate	—	R	Phosphoric Acid	85	R
Boric Acid	—	R	Phosphorous (Yellow)	—	R
Bromic Acid	—	R	Phosphorous Pentoxide	—	R
Bromine (Liquid)	—	N	Phosphorous Trichloride	—	N
Bromine (Water)	—	LR	Plating Solutions	—	R
Calcium Chloride	Saturated	R	Potassium Bichromate	—	R
Calcium Hydroxide	—	R	Potassium Bromate	—	R
Calcium Hypochlorite	—	R	Potassium Bromide	Saturated	R
Calcium Nitrate	—	R	Potassium Chloride	—	R
Calcium Sulfate	—	R	Potassium Chlorate	—	R
Carbon Disulfide	—	N	Potassium Chromate	—	R
Carbon Tetrachloride	—	N	Potassium Cyanide	—	R
Chlorine Dioxide	15	R	Potassium Dichromate	—	R
Chlorine Gas (Dry)	—	R	Potassium Ferricyanide	—	R
Chlorine Gas (Wet)	—	LR	Potassium Fluoride	—	R
Chlorine Water	2	R	Potassium Hydroxide	50	R
Chromic Acid	10	R	Potassium Nitrate	—	R
Citric Acid	Saturated	R	Potassium Perborate	—	R
Copper Nitrate	—	R	Potassium Perchlorate	—	R
Copper Sulfate	—	R	Potassium Permanganate	10	R
Ferric Chloride	Saturated	R	Potassium Persulfate	—	R
Ferric Nitrate	—	R	Potassium Sulfate	—	R
Ferric Sulfate	—	R	Selenic Acid	—	R
Ferrous Chloride	—	R	Silicic Acid	—	R

PHASE-2 PVC

**R** — Resistant    **LR** — Limited Resistance    **N** — Not Resistant

Chemical	Concentration %	Resistance	Chemical	Concentration %	Resistance
Silver Nitrate	—	R	Sodium Nitrite	—	R
Sodium Acetate	—	R	Sodium Perchlorate	—	R
Sodium Benzoate	—	R	Sodium Peroxide	—	R
Sodium Bicarbonate	—	R	Sodium Sulfate	—	R
Sodium Bichromate	—	R	Sodium Sulfide	—	R
Sodium Bisulfate	—	R	Sodium Sulfite	—	R
Sodium Bisulfite	—	R	Sodium Thiosulfate	—	R
Sodium Carbonate	—	R	Stannic Chloride	—	R
Sodium Chlorate	—	R	Stannous Chloride	—	R
Sodium Chloride	—	R	Sulfur Dioxide (Gas)	Dry	R
Sodium Chlorite	—	N	Sulfuric Acid	80	R
Sodium Cyanide	—	R	Tartaric Acid	Saturated	R
Sodium Dichromate	—	R	Trisodium Phosphate	—	R
Sodium Ferricyanide	—	R	Urea	—	R
Sodium Ferrocyanide	—	R	Zinc Chloride	—	R
Sodium Fluoride	—	R	Zinc Nitrate	—	R
Sodium Hydroxide	50	R	Zinc Sulfate	—	R
Sodium Hypochlorite	16 Chlorine	R			



In as much as H & F Manufacturing Corporation's material has many approved uses, any non-standard use should be tested by the user to determine its suitability. Proper installation techniques must be in accordance with H & F Manufacturing Corporation's procedures and H & F will not be liable for damages due to improper installation. In accordance with our company's continual product development, you are advised to check with your H & F supplier to ensure that you have the most up-to-date information.

### Poly 75 Series RTV Liquid Rubbers

#### Economical, Flexible Polyurethane Rubbers for Molds and Parts

**DESCRIPTION:** Poly 75 Series Liquid Rubbers consist of two parts (A & B) that, after mixing, cure at room temperature to flexible rubber. Molds made with Poly 75 Series products are excellent for casting concrete, plaster and wax. In addition, when coated with a proper release agent, Poly 75 Series molds can also be used to cast various resins. Poly 75 Series Liquid Rubbers have been formulated for good economy with high performance and durability.

**MODEL PREPARATION:** Porous models, such as wood, plaster, stone, pottery or masonry, must be sealed, then coated with a release agent. Multiple coats of paste wax dried and buffed will seal most surfaces. Potters soap can be used as a sealer for plaster. Lacquer, paint, PVA, and Pol-Ease® 2350 Release Agent also work well as sealers for many surfaces. Models made of sulfur-containing modeling clay (i.e., Roma Plastilina) should be sealed with shellac. *[CAUTION: When shellac is used as the sealer, it must be thoroughly coated with release agent because polyurethane rubbers bond tenaciously to shellac. In fact, uncoated shellac may be used to bond polyurethanes to certain surfaces.]*

Non-porous models (i.e., metals, plasticene, wax, glazed ceramics, fiberglass, and polyurethanes) and sealed porous models should be coated with a release agent such as Pol-Ease 2300.

If there is any question about the compatibility between the liquid mold rubber and the prepared model surface, perform a test cure on an identical surface to determine that complete curing and good release is obtained.

Porous models must be vented from beneath to prevent trapped air from forming bubbles in the rubber.

**MIXING & CURING:** Before mixing, be sure that both Parts A and B are at room temperature and that all tools and models are ready to go! Some products set fast -- meaning that you must work quickly.

Check mix ratio. Weigh Part B into a clean metal or plastic mixing container and then weigh the appropriate amount of Part A

#### FEATURES

- Easy-to-use formulations
- Flexible, high-strength mold rubbers
- Reproduce finest details
- Make tough, long-lasting, abrasion-resistant molds and parts

into the same container. Mix thoroughly. Hand mixing with a Poly Paddle is best to avoid mixing air into the rubber. While mixing, scrape the sides and bottom several times to ensure thorough mixing. Pour the rubber as soon after mixing as possible for best flow and air bubble release.

Vacuum degassing helps to provide bubble-free molds but is usually not necessary.

Allow to cure at room temperature, 77°F (25°C). Final cure properties are obtained in about seven days, but molds may be used with care after curing for 24-48 hours. Heat accelerates the cure - low temperatures slow the cure. Avoid curing in areas where the temperature is below 60°F (15°C).

Both Parts A and B react with atmospheric moisture and, therefore, should be resealed or used up as soon as possible after opening. Before resealing, Poly Purge™, a heavier-than-air dry gas, can be sprayed into open containers to displace moist air and extend storage life. For 55-gallon drums of Parts A and B, affix Drierite cartridges on the small bung during dispensing to protect product from moist air entering the drum.

**SOFTENING THE RUBBER:** Add Poly 74/75 Part C Softener to 75 Series products for a lower viscosity mix and a softer cured rubber. When using Part C, cure time is longer and there is some loss of strength in the rubber and increased tendency to shrink after repeated castings. The quantity of Part C required varies and should be determined through experimentation.

#### PHYSICAL PROPERTIES

	75-59	75-60	75-65	75-70	75-75	75-79	75-80	75-90
Mix Ratio, By Weight	1A:1B	1A:1B	1A:1B	1A:1B	2A:1B	2A:1B	2A:1B	2A:1B
Hardness, Shore A	60	60	65	70	75	80	80	90
Pour Time (min)	10	10	35	40	20	20	45	10-15
Cured Color	Amber	Amber	Yellow/Amber	Gray	Amber	Yellow	Yellow/Amber	Tan/Brown
Mixed Viscosity (cP)	2,500	1,200	3,000	3000	4,000	2,000	5,000	6,000
Specific Volume, in <sup>3</sup> /lb	27	27	27	27	26	26	26	26



PACKAGING					
Product	Total Unit Weight	Containers			
		Size		Net Weight (lb)	
		A	B	A	B
<b>Poly 75-59, 75-60, 75-65 &amp; 75-70</b> Mix Ratio 1A:1B	4 lb	1 qt	1 qt	2.0	2.0
	16 lb	1 gal	1 gal	8.0	8.0
	80 lb	5 gal	5 gal	40.0	40.0
	900 lb	55 gal	55 gal	450	450
<b>Poly 75-75, 75-79, 75-80 &amp; 75-90</b> Mix Ratio 2A:1B	6 lb	2x1 qt	1 qt	4.0	2.0
	24 lb	2x1 gal	1 gal	16.0	8.0
	120 lb	2x5 gal	5 gal	80.0	40.0
	1,350 lb	2x55 gal	55 gal	900	450

**ACCELERATING THE CURE:** Add Poly 74/75 Part X to Poly 75 Series rubbers to accelerate the cure. By adding 1% Part X (by weight of total mix) to Poly 75-80, the working time is reduced to approximately 10 minutes and demolding is possible in as little as 6 hours. Exercise caution when using Part X since the rapid onset of gelling may trap air bubbles on or near the surface of the model.

**USING THE MOLD:** Usually no release agent is necessary when casting plaster or wax in Poly 75 Series molds. For casting plaster, sponge, dip or spray the mold with Pol-Ease Mold Rinse and then pour plaster on the wet mold to reduce air bubbles in the plaster and aid release. For casting resin, first spray the mold with Pol-Ease 2300 Release Agent. For casting concrete, use an appropriate form release such as Pol-Ease 2650 or 2601. Avoid solvent-containing releases since they can cause mold distortion (i.e., shrinkage or swelling).

After repeated casting with certain resins, plaster and concrete, molds may shrink slightly since these materials extract oils from the mold. The proper selection of release agent and/or barrier coat can minimize this effect. If shrinkage becomes evident, a light application of Pol-Ease Mold Dressing can help to restore the mold to its original dimensions.

Poly 75 Series molds can last many years if stored undistorted on a flat surface in a cool, dry location out of direct sunlight. If occasional outdoor use is required, Poly 75-59, 75-65 and 75-80 perform best and UV resistance can be improved by adding Poly UV Additive. Add 0.5% UV Additive to the total mix weight to reduce the characteristic surface degradation caused by sunlight. Never store Poly 75 Series molds outside as UV exposure will eventually degrade the rubber.

**CLEAN UP:** Tools should be wiped clean before the rubber cures. Denatured ethanol is a good cleaning solvent, but it must be handled with extreme caution owing to its flammability and health hazards. Work surfaces can be waxed or coated with Pol-Ease 2300 Release Agent so cured rubber can be removed.

**SAFETY:** Before use, read product labels and Material Safety Data Sheets. Follow safety precautions and directions. Contact with uncured products may cause eye, skin and respiratory irritation and dermal and/or respiratory sensitization. Avoid contact with skin and eyes. If skin contact occurs, remove with waterless hand cleaner then soap and water. In case of eye contact, flush with water for 15 minutes and call physician. Use only with adequate ventilation. Poly 75 Series products are not to be used where food or body contact may occur. Poly 75 Series products burn readily when ignited.

**STORAGE LIFE:** At least six months in unopened containers stored at room temperature (60-90°F/15-32°C).

**DISCLAIMER:** The information in this bulletin and otherwise provided by Polytek® is considered accurate. However, no warranty is expressed or implied regarding the accuracy of the data, the results to be obtained by the use thereof, or that any such use will not infringe any patent. Before using, the user shall determine the suitability of the product for the intended use and user assumes all risk and liability whatsoever in connection therewith.

July 7, 2005/75.qxd

ACCESSORIES
<b>Poly 74/75 Part C Softener</b> 1 pint (1 lb), 1 gal (8 lb), 5 gal (40 lb)
<b>Poly 74/75 Part X Accelerator</b> 1 pint (1 lb), 1 gal (8 lb)
<b>Pol-Ease® 2300 Release Agent</b> 12-oz can, case of 12 cans
<b>Pol-Ease® 2350 Release Agent</b> 1 qt (1.5 lb), 5 gal (26 lb)
<b>Pol-Ease® 2601 Release Agent</b> 1 qt (2 lb), 5 gal (40 lb), 1 drum (450 lb)
<b>Pol-Ease® 2650 Silicone-Free Release Agent</b> 1 qt (1.5 lb), 5 gal (35 lb), 1 drum (375 lb)
<b>Pol-Ease® Mold Dressing</b> 5 gal (40 lb)
<b>Pol-Ease® Mold Rinse</b> 5 gal (40 lb)
<b>Poly PVA Solution (Green or Clear)</b> 1 qt (2 lb), 5 gal (40 lb)
<b>Poly UV Additive</b> 4 oz, 1 pt (1 lb)
<b>Poly Purge™ Aerosol Dry Gas</b> 10-oz can, case of 12 cans

55 Hilton Street, Easton, PA 18042 • (800) 858-5990 or (610) 559-8620 • fax (610) 559-8626 • www.polytek.com • sales@polytek.com

