

**US Army Corps
of Engineers®**
Cold Regions Research &
Engineering Laboratory

Performance Testing of Hot-Mix Asphalt Aggregates

Vincent C. Janoo and Charles Korhonen

December 1999

Abstract: Hot-mix asphalt (HMA) pavements are subject to thermal cracking, fatigue cracking, rutting, stripping, raveling, and freeze-thaw damage. Some of these distresses are directly affected by the choice of aggregates. Particle shape, surface texture, particle size, pore structure, and particle strength are the most

common characteristics cited for controlling rutting and for maintaining adequate skid resistance. A literature review was conducted to evaluate commonly used and potential test methods for evaluating hot-mix aggregates in term of pavement performance.

How to get copies of CRREL technical publications:

Department of Defense personnel and contractors may order reports through the Defense Technical Information Center:

DTIC-BR SUITE 0944
8725 JOHN J KINGMAN RD
FT BELVOIR VA 22060-6218
Telephone 1 800 225 3842
E-mail help@dtic.mil
msorders@dtic.mil
WWW <http://www.dtic.mil/>

All others may order reports through the National Technical Information Service:

NTIS
5285 PORT ROYAL RD
SPRINGFIELD VA 22161
Telephone 1 703 487 4650
1 703 487 4639 (TDD for the hearing-impaired)
E-mail orders@ntis.fedworld.gov
WWW <http://www.ntis.gov/index.html>

A complete list of all CRREL technical publications is available from

USACRREL (CEERD-IM-HL)
72 LYME RD
HANOVER NH 03755-1290
Telephone 1 603 646 4338
E-mail techpubs@crrel.usace.army.mil

For information on all aspects of the Cold Regions Research and Engineering Laboratory, visit our World Wide Web site:

<http://www.crrel.usace.army.mil>

Special Report 99-20

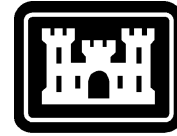

**US Army Corps
of Engineers®**
Cold Regions Research &
Engineering Laboratory

Performance Testing of Hot-Mix Asphalt Aggregates

Vincent C. Janoo and Charles Korhonen

December 1999

Prepared for
NEW HAMPSHIRE DEPARTMENT OF TRANSPORTATION

Approved for public release; distribution is unlimited.

PREFACE

This report was prepared by Dr. Vincent Janoo and Charles Korhonen, Research Civil Engineers, Civil Engineering Research Division, U.S. Army Cold Regions Research and Engineering Laboratory (CRREL). The report was prepared in cooperation with the New Hampshire Department of Transportation and the U.S. Department of Transportation, Federal Highway Administration.

Funding for this project was provided by the New Hampshire Department of Transportation through an intergovernmental cooperative agreement.

The work was conducted at CRREL, and the authors wish to acknowledge the contributions of the following people for successful completion of this project: Technical review of the report was provided by Sally Shoop of CRREL, Richard Lane of the New Hampshire Department of Transportation, and David Hall of the Federal Highway Administration. The authors wish to express their gratitude to Lynette Barna, Civil Engineering Research Division, for preparation and editorial changes of the document. Assistance from the CRREL Technical Information Branch was provided by Dawn Boden in preparation of the graphics used in this report and Maria Bergstad and David Cate in editing and publishing assistance. Recognition is also extended to Bruce Ashley of the Logistics Management Office for reproduction services.

The contents of this report reflect the views of the authors, who are responsible for the facts and the accuracy of the data presented herein. The contents do not necessarily reflect the official views or policies of the New Hampshire Department of Transportation or the Federal Highway Administration at the time of publication. This report does not constitute a standard, specification, or regulation.

CONTENTS

Preface	1
Introduction	1
Parameters and tests indicative of rutting performance	2
Particle index	4
Rugosity	5
Uncompacted voids in aggregates	7
Time index	9
Characterization summary	9
Parameters influencing skid resistance	9
Roughness and texture	10
Macrotexture characterization	12
Microstructure characterization	13
Friction measurement devices	13
Polish–wear testing devices	15
British Accelerated Wear and Polishing Device	15
Small-wheel circular track polishing machine	16
Projection method	16
Summary of test equipment	17
Evaluating frost resistance of pavement aggregates	17
Soundness test	17
Unconfined freeze–thaw test	18
Confined rapid freeze–thaw test	18
Hydraulic fracture test	18
Cryogenic test	19
Slow freeze test	19
VPI single-cycle freeze test	19
Iowa Pore Index test	19
Summary and recommendations	20
Literature cited	20
Abstract	23

ILLUSTRATIONS

Figure

1. Influence of aggregate roundness on rutting potential of asphalt concrete mixtures	2
2. Aggregate classification chart	3
3. Roundness chart for 16- to 32-mm aggregates	3
4. Degree of angularity	4
5. Comparison of pararticle index values for rounded and crushed coarse aggregates ..	4
6. Particle index for different aggregate gradations	5

Figure	
7. Description of pouring device	6
8. Effect of aggregate type on specific rugosity	6
9. NAA particle shape and texture void contents vs. percent natural sand in fine aggregate	7
10. Test apparatus for ASTM C 1252 and modified ASTM C 1252	8
11. Modified NAA particle shape and texture and void contents	8
12. QMOT time index test apparatus	9
13. Road surfacing textural characteristics	10
14. Correlation between macrotexture, microtexture, skid resistance, and speed	10
15. Pavement surface characteristics	11
16. Effect of pavement texture on skid resistance	11
17. Containers of test materials for sand patch test	12
18. Circular patch of test material	12
19. Measurement of diameter of sand patch	12
20. British portable skid resistance tester	13
21. Relationship between British pendulum number and Illinois skid trailer number ...	14
22. Correlation between variable-speed number and skid trailer number at 40 mph	14
23. British wear and polishing device	15
24. Water projection device	16
25. Specimen for projection method	16
26. Correlation between on-road British pendulum number and polishing by projection coefficient C_{pp}	17

TABLE

Table	
1. Recommended aggregate tests	1

Performance Testing of Hot-Mix Asphalt Aggregates

VINCENT C. JANOO AND CHARLES KORHONEN

INTRODUCTION

When one thinks of hot-mix asphalt (HMA) pavement distresses, the following come to mind: thermal cracking, rutting, fatigue cracking, raveling, and moisture-induced damage (stripping). Some of these, such as low temperature and fatigue cracking, are more directly related to the properties of the asphalt cement. The aggregates play a minor role in crack retardation once a crack has formed. Rutting and moisture-induced damage are not only dependent on the asphalt content but on the characteristics of the aggregates in the mixture as well, and thus a proper selection of aggregates can reduce rutting and moisture-induced damage to HMA. For example, rutting can be reduced by the use of large aggregates, and/or angular rough coarse and fine aggregates. Raveling is more of a mixture-proportioning problem, i.e., the amount of asphalt cement in the mixture is critical. Low asphalt content can accelerate the raveling of an HMA mixture. Another distress, not usually mentioned, is the amount of change in skid resistance. Here again, a proper choice of aggregate surface characteristics and shape qualities can significantly enhance skid resistance.

Although aggregates constitute approximately 90% of an HMA mixture, there is no performance grading of aggregates similar to the Strategic Highway Research Program (SHRP) PG system for asphalt cement. Many ASTM and AASHTO index tests attempt to characterize the qualities of aggregates needed for HMA mixtures; they measure size and gradation, aggregate

cleanliness, toughness/hardness, durability soundness, surface texture, particle shape, absorption, and affinity for asphalt. These tests however, do not give any clear indication of the performance of the aggregates in HMA with respect to the distresses mentioned above. SHRP realized the importance of aggregate properties on the performance of HMA pavements, but due to a lack of funds and time, the selection of aggregate properties for the SUPERPAVE mixes was based on "expert consensus." SHRP retained some previously used aggregate tests, such as determining the proportion of flat and elongated particles, sand equivalent tests for determining the amount of plastic fines and dust in the fine aggregates, and the shape and angularity of both the coarse and fine aggregates. No tests were recommended for skid resistance.

Realizing this shortfall, the National Cooperative Highway Research Program (NCHRP) conducted a study on the relationship between exist-

Table 1. Recommended aggregate tests (Kandhal and Parker 1998).

<i>Aggregate properties</i>	<i>Fatigue cracking</i>	<i>Permanent deformation</i>	<i>Raveling</i>	<i>Moisture-induced damage (stripping)</i>
Gradation and size	x	x		
Uncompacted void content of coarse aggregates	x	x		
Uncompacted void content of fine aggregates		x		
Methylene blue tests of fine aggregates				x
Methylene blue test of P200 materials				x
Micro-Deval tests			x	
Magnesium sulfate soundness tests			x	
Particle size analysis of P200 material		x		x

ing aggregate tests and asphalt concrete performance (Kandhal and Parker 1998). The study, based only on laboratory evaluation, recommended a set of aggregate tests that relate to rutting, fatigue cracking, raveling, and stripping performance of HMA pavements (Table 1).

This report discusses test methods proposed by NCHRP for rutting susceptibility and focuses on the two areas not covered by the NCHRP report: skid resistance and freeze–thaw durability characterization. The report also focuses on aggregate characterization and not on test methods that involve mixture testing.

PARAMETERS AND TESTS INDICATIVE OF RUTTING PERFORMANCE

Particle shape, surface texture, particle size, pore structure, and particle strength appear to be the most common characteristics cited for controlling rutting.

Permanent flow or rutting from traffic loading is due to densification and plastic flow of the HMA mixture at high temperatures. Factors such as asphalt content, asphalt grade, air voids and aggregate characteristics, construction practices, temperature, and increase in traffic load/repetitions all have an influence on the rutting potential of a mixture. Although all these factors are important, the effect of aggregates, which comprise up to 90% of the mixture, plays a significant role in controlling rutting, as seen by the recent intro-

duction of stone matrix asphalt (SMA) mixtures in the USA.

To minimize rutting, aggregate interlock is crucial. The shape, angularity, and surface texture of the aggregate affect the interlock. However, this interlock appears to be critical for the fine aggregates, as noted by Uge and Van de Loo (1974), who reported that use of rounded coarse aggregate with crushed fine aggregate also produced rut-resistant HMA mixtures (Fig. 1). A discussion of the various factors that affect pavement rutting can be found in Janoo (1990).

The quantification of the shape, angularity, and surface texture of an aggregate is difficult but not impossible. Several methods involve either direct measurements of aggregate or indirect inference from aggregate properties or from mixture testing. For example, for coarse aggregates, engineers have developed visual classification methods to characterize shape and angularity or index tests that use engineering properties such as porosity to speculate on the shape, angularity, and surface texture of aggregates. In the index test developed by engineers, however, it is not possible to quantify separately the shape, the angularity, or the surface texture. Usually they are lumped together as geometric irregularities. Details on quantification of the shape, angularity, and surface texture of aggregates can be found in Janoo (1998). For coarse aggregates, geologists have a sophisticated system that involves physical measurement of the aggregates. As used by

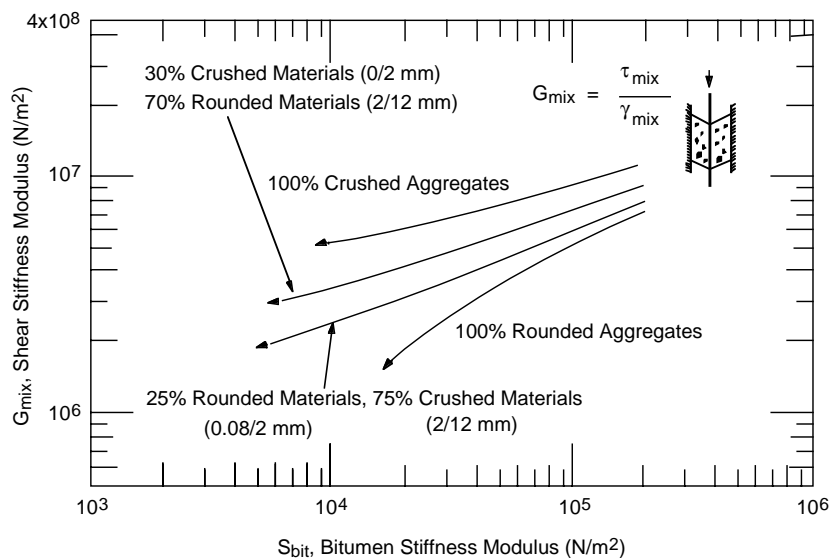

Figure 1. Influence of aggregate roundness on rutting potential of asphalt concrete mixtures.

petrologists, the shape of a coarse aggregate can be described by its length, width, thickness, sphericity, roundness, and angularity. Aggregate classification charts to evaluate shape, roundness, and angularity of aggregates are shown in Figures 2, 3, and 4. Surface texture is more difficult to determine. Traces of magnified surfaces have been used to describe surface texture (Wright 1955). Others, such as Barksdale and Itani (1994), developed roughness scales to describe the texture of aggregates.

For fine aggregates, shape and angularity can be described with image analysis. Computer-

based image analysis has been developed for analyzing aggregate shape, angularity, and roughness. A feasibility study conducted for the Federal Highway Administration (FHWA) on this technology (Wilson et al. 1995) showed that image analysis is a viable tool for distinguishing the shape and angularity of fine sands (manufactured vs. natural). The method involves first capturing magnified images of the aggregates using a high-resolution video camera, and then using an image analysis program to identify and separate the objects and trace the edges of the aggregates. Based on the traces, algorithms in the programs are used to determine the different characteristics of the aggregates. The Quebec Ministry of Transportation (QMOT) routinely uses image analysis of the HMA fine aggregates to distinguish roundness and angularity of the fine aggregates. Additional descriptions of this method can be found in Janoo (1998).

An alternate approach taken by engineers is to infer these characteristics from the mass properties of the aggregates. Several indices such as angularity number, time index, particle index, and rugosity have been identified in the literature.

For coarse aggregates, the angularity number (AN) developed by Shergold (1953) is recommended by the British Standards Institution (1989) for indexing the angularity of natural and crushed aggregates used in concrete. This technology can be easily transferred to HMA. Shergold found that when the aggregates were compacted in a prescribed fashion, the percentage of

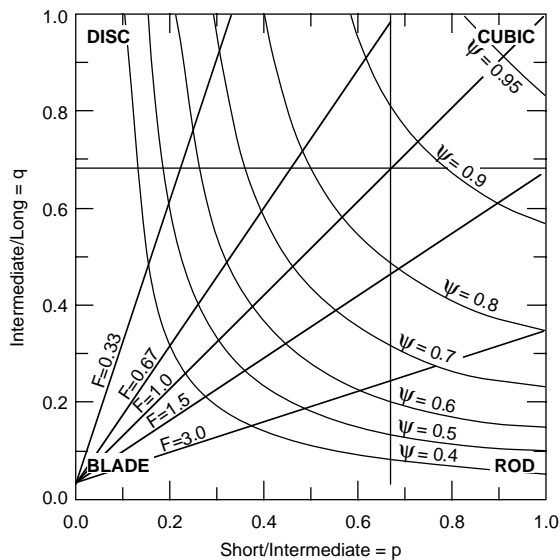

Figure 2. Aggregate classification chart.

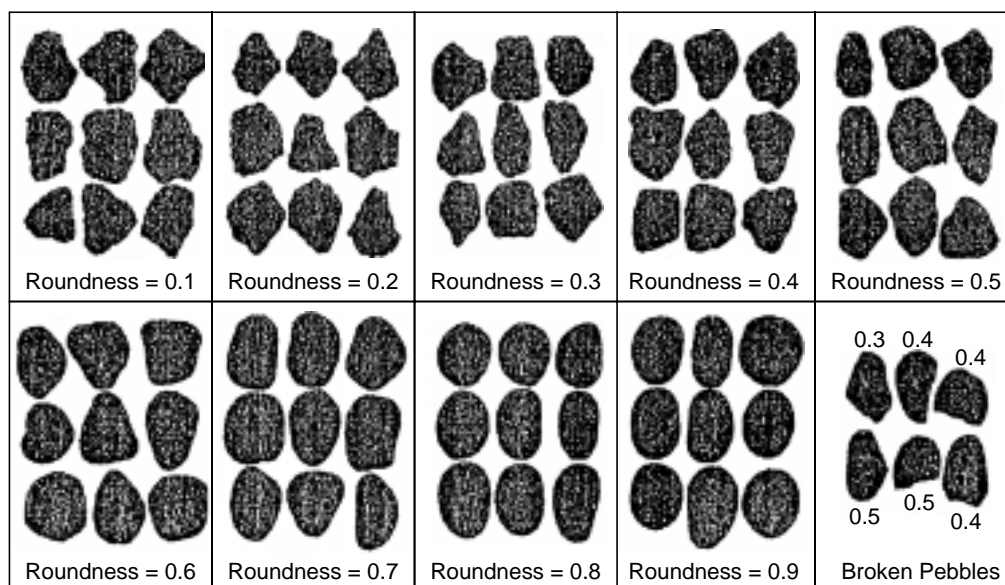

Figure 3. Roundness chart for 16- to 32-mm aggregates.

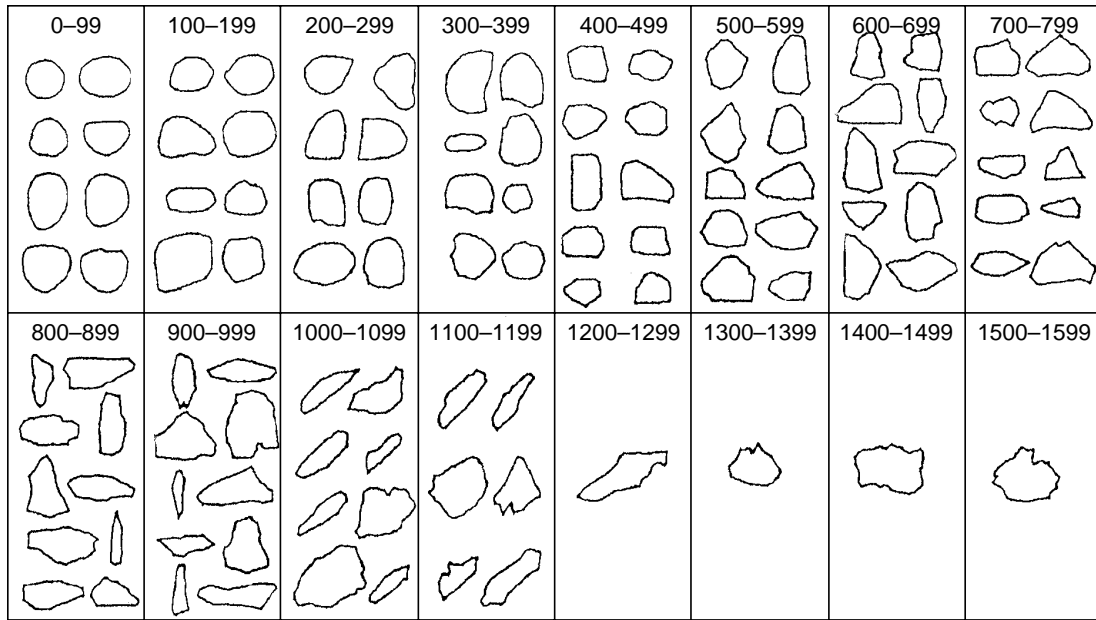

Figure 4. Degree of angularity.

voids in the aggregate mass decreased as the aggregates became more rounded. He also found that as the amount of round gravel increased in a mixture of natural and crushed aggregates, the percentage of voids also decreased. Using round gravel as a reference point, he characterized the angularity of all other aggregates as the difference between the percent voids and 33%. AN is found to range between 0 and 12:

$$AN = \text{percent voids} - 33. \quad (1)$$

Particle index

Another index for characterizing the coarse and fine aggregates in an HMA mixture is the particle index (I_a). The particle index is based on the concept that the shape, angularity, and surface texture of uniformly (single) sized aggregate affects not only the void ratio but also the rate at which the voids change when compacted in a standard mold (Huang 1962). The particle index (I_a) is calculated using eq 2:

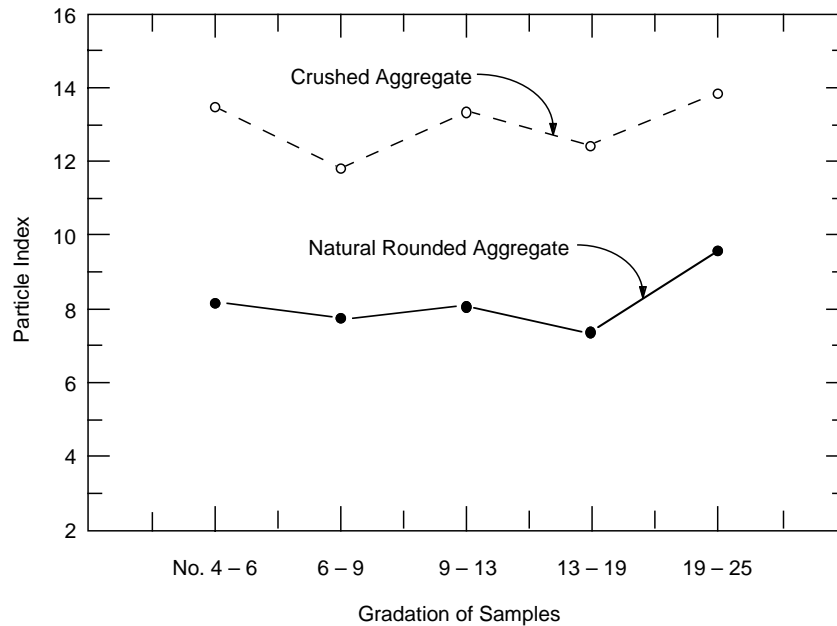

Figure 5. Comparison of particle index values for rounded and crushed coarse aggregates.

$$I_a = 1.25V_{10} - 0.25V_{50} - 32 \quad (2)$$

where V_{10} = % of voids in aggregates at 10 strokes per layer and V_{50} = % of voids in aggregates at 50 strokes per layer.

The results (Fig. 5) indicate that the test method is capable of distinguishing the difference between natural rounded and rough, angular aggregates by the increasing particle index value.

The test is time-consuming because the particle index is developed for individual sieve size aggregates. The Michigan Department of Transportation (Michigan DOT 1983) studied the effect

to separate the interaction of angularity and roughness on aggregate performance. They proposed that the effect of both angularity and roughness be combined into a single term called 'rugosity.'

Later, Ishai and Tons (1971) developed an index to describe this rugosity, called the specific rugosity (S_{rv}). S_{rv} will be approximately equal to zero for smooth spherical particles:

$$S_{rv} = 100 \left(\frac{V_{sr}}{V_p} \right) = 100 \left[1 - \left(\frac{G_{px}}{G_{ap}} \right) \right] \quad (3)$$

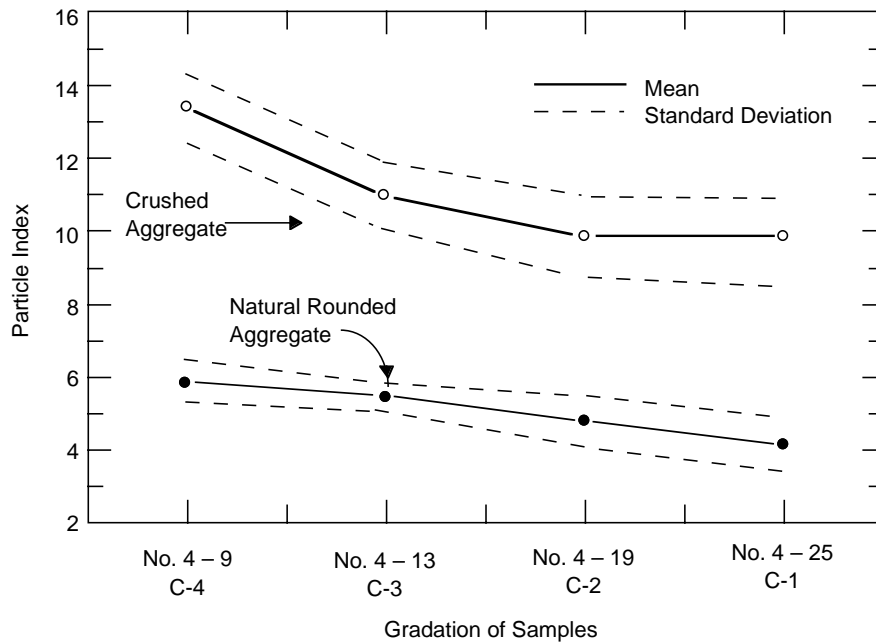

Figure 6. Particle index for different aggregate gradations.

of combining the different sieve sizes on the particle index. The effectiveness of the index in differentiating between natural and crushed aggregates was consistent for all combinations (Fig. 6).

Rugosity

Another method based on flow of aggregates through a given sized orifice can also be used to differentiate physical aggregate properties. The initial work with HMA aggregates was done by Tons and Goetz (1968), who developed the packing volume concept to characterize the shape, angularity, and roughness of the aggregates used in bituminous mixtures. The test was developed for both the coarse (12 mm) and fine fractions. They found that although the shape of the particle could be quantified separately, it was difficult

where S_{rv} = specific rugosity (%)
 V_{sr} = volume between the packing volume membrane and the volume of macro- and microsurface voids
 V_p = packing volume of the particle
 G_{px} = packing specific gravity
 G_{ap} = apparent specific gravity.

The apparent specific gravity can be calculated using ASTM C 127-88 (1995), *Standard Test for Specific Gravity and Absorption of Coarse Aggregate* (AASHTO T 85-85 1998). G_{px} is determined from the pouring test developed by Ishai and Tons (1977). The pouring test involves taking two single-sized samples and pouring them into a standard container using a standard procedure. One of the particles used is a standard (smooth,

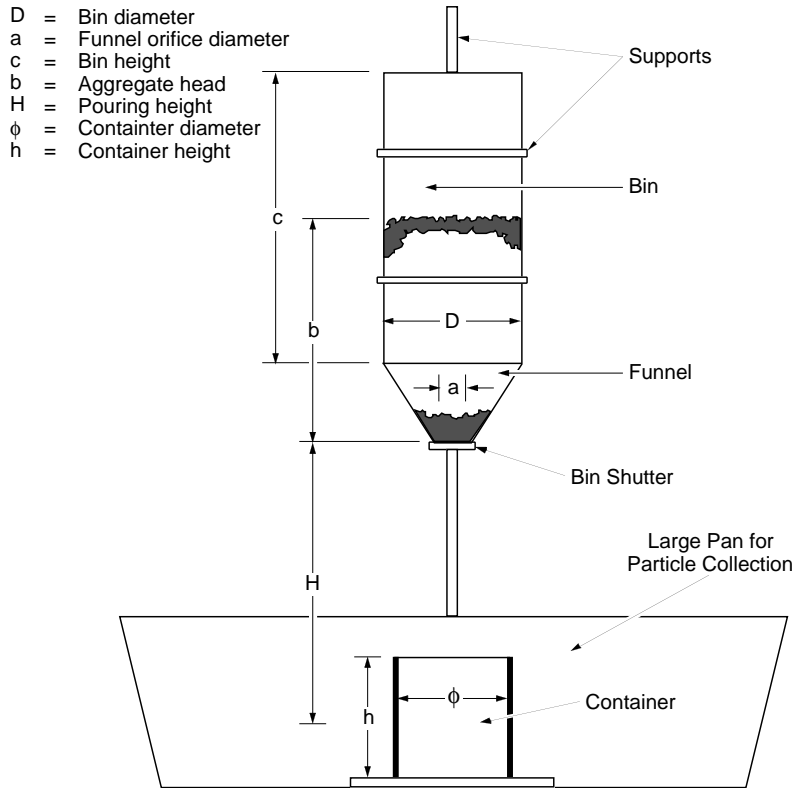

Figure 7. Schematic description of pouring device.

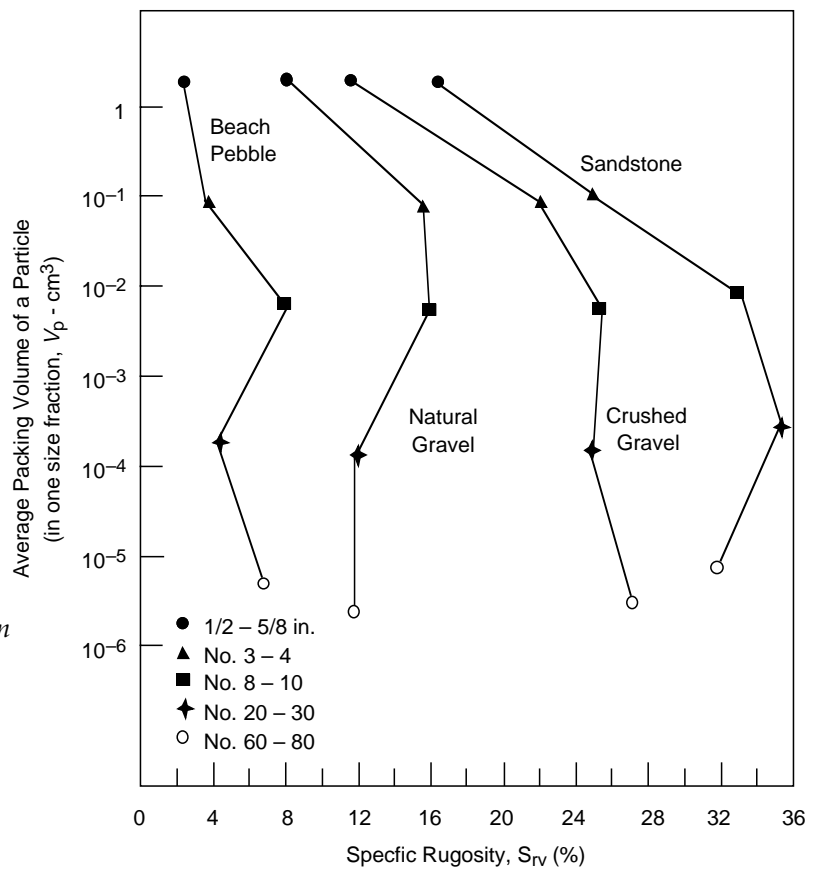

Figure 8. Effect of aggregate type on specific rugosity.

spherical glass beads) with a known packing specific gravity, G_{ps} . The other sample is the test particles for which G_{px} is sought. G_{px} is a function of the ratio of the weight of the test particles to the standard particles:

$$G_{px} = \left(\frac{\sum W_x}{\sum W_s} \right) G_{ps}. \quad (4)$$

A schematic of the pouring test is given in Figure 7. Typical results on the effect of different aggregates on the specific rugosity are shown in Figure 8. The specific rugosity increases as the angularity and roughness increase. One drawback of this test is that it is time-consuming because tests have to be done on individual sieve sizes.

Uncompacted voids in aggregates (ASTM C 1252)

This test method is similar to the specific rugosity test described above. The exception is that the aggregates need not be separated into various sieve sizes. The test for fine aggregates has been standardized by ASTM C 1252 (1995), *Standard Test Methods for Uncompacted Void Content of Fine Aggregate (as Influenced by Particle Shape, Surface Texture, and Grading)*. Initially developed by the National Aggregate Association (NAA), it involves allowing the fine aggregates to fall freely into a calibrated cylinder from a specified height. The excess material is removed and weighed. The

weight of aggregate together with the bulk specific gravity of the aggregate are used to calculate the uncompacted void content:

$$UCV = \frac{V_{cyl} \frac{M}{G_{sb}}}{V_{cyl}} \times 100 \quad (5)$$

where UCV = uncompacted void content (%)

V_{cyl} = volume of cylinder (cm^3)

M = mass of aggregate in cylinder (g)

G_{sb} = bulk specific gravity of aggregates.

Figure 9 shows the UCV increasing with increasing percent of crushed fine particles. Method A in Figure 9 refers to a standard gradation of the fine aggregates (i.e., the gradation of selected sieve sizes), and method C refers to the gradation of the minus no. 4 portion of the as-received material. The standard gradation in method A consists of a gradation made from a known weight of material from specific sieves.

Aldrich (1996) modified this test for determining the uncompacted void content of coarse aggregates. A schematic of both the fine and coarse aggregate test apparatus is shown in Figure 10. The test coarse aggregate passed the 19-mm sieve and was retained on the no. 4 sieve. A test protocol similar to that used in ASTM C 1252 (1995) was developed for the coarse aggregates. Utilizing method 1, 5000 g of as-received material is used, or individual aggregate sizes ranging

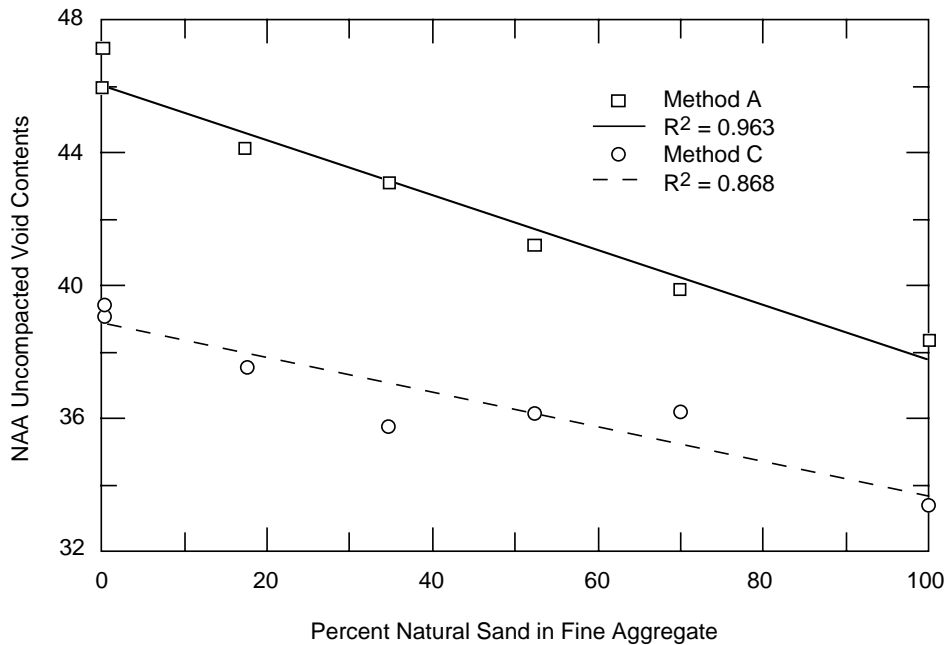

Figure 9. NAA particle shape and texture void contents vs. percent natural sand in fine aggregate

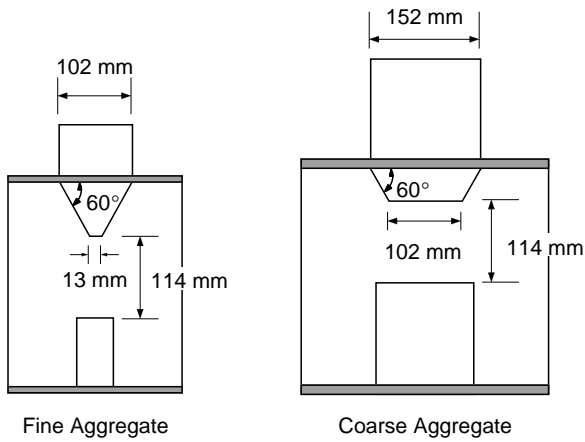

Figure 10. Test apparatus for ASTM C 1252 and modified ASTM C 1252.

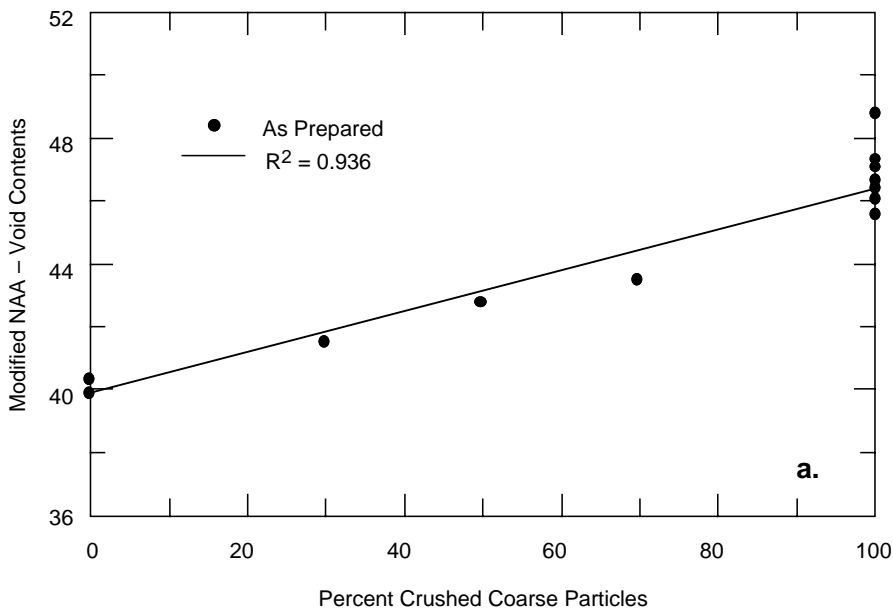
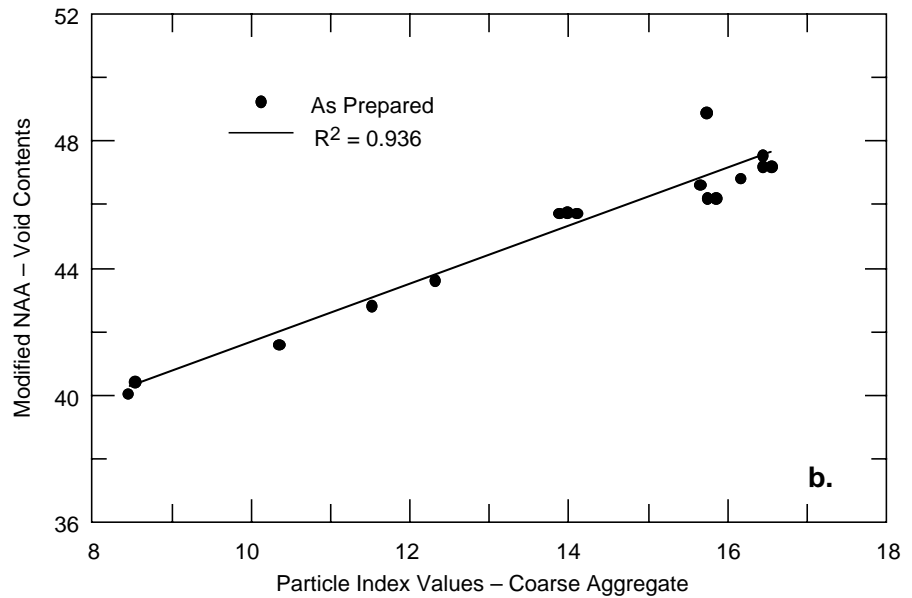

Figure 11. Modified NAA particle shape and texture void contents vs. (a) percent crushed particles (Aldrich 1996), and (b) particle index values of coarse aggregate.



from 19 to 25 mm, 25 to 9.5 mm, and 9.5 mm to no. 4 are tested separately and the UCV averaged from the individual fraction sizes. As shown in Figure 11a, the modified NAA method developed by Aldrich (1996) for the coarse fraction of the HMA mixture clearly indicates that the UCV increases with increasing percent of crushed coarse particles. In addition, Aldrich (1996) showed a good correlation between the results from the modified NAA test for coarse aggregates and the particle index value (Figure 11b). Overall, this is a fairly simple test to conduct, and correlation between rutting potential and aggregate characterization can be easily developed.

Time index

Similar in concept to the uncompacted void tests, a test method developed by the Quebec Ministry of Transportation characterizes the angularity and surface texture of aggregates using the rate of flow of the aggregate through a known-diameter opening (Fig. 12). Additional details on this apparatus can be found in Janoo (1998).

The index, the flow coefficient (C_e), is a function of the time it takes 7 kg of material to move through a 60-mm-diameter opening for material passing the 20-mm sieve and retained on the 4-mm sieve. A different size is used for the fine aggregates. In addition, the flow coefficient depends on the bulk specific gravity. Based on

limited tests, the flow coefficient for crushed gravel was 92.2 and for crushed stone was 115 (Janoo 1998).

Characterization summary

In summary, it was found that several methods are available for characterizing the shape, angularity, and surface texture of HMA aggregates. It is difficult to separate the effect of individual features of the aggregate, with the exception of petrographic methods. All of the tests tend to provide the effect of the overall shape, angularity, and roughness. The NAA and modified NAA tests seem the easiest to use and implement. The time flow test used by the Quebec Ministry of Transportation also appears to be easy to implement.

PARAMETERS INFLUENCING SKID RESISTANCE

For HMA pavements, skid resistance depends on the friction developed between the pavement surface and the tire. This friction is dependent on the microscopic and macroscopic roughness of the pavement surface, the polish-wear characteristics of the aggregates, and the ability of the surface to drain (Beaton 1976). Marek (1972) reported that 50% of the initial skid resistance is lost during the first two years of pavement service and that the single most important factor that affects the reduction of skid resistance is the polishing characteristics of the aggregates in an HMA mix. Other factors that affect the skid resistance of the pavement surface are wetness of the surface, seasonal variation, and temperature.

The skid resistance of a wide range of dry surfaces is high and fairly constant. When these surfaces get wet, however, the skid resistance drops and is very dependent on the surface type. There is seasonal variation: the skid resistance is higher on wet roads during the winter than in the summer (Hosking and Woodford 1976) because in winter the road surface is contaminated by sanding and salting and the removal of fine material increases the roughness of the microtexture. In the summer, continuous abrasion of the macrotexture produces fines that coat the microtexture and reduce the skid resistance.

The friction of the surface is indexed from field tests following various standardized tests (ASTM E 274 [1994] and E 1551[1994]). The procedure is based on measurements of the frictional force developed between a standard tire at a standard inflation pressure and the wetted pavement sur-



Figure 12. QMOT time index test apparatus.

face. Since the frictional force between the tire and the pavement surface is a function of the vehicle speed, it is usually reported at a speed of 65 km/hr. The frictional coefficient is multiplied by 100 and reported as the skid number (SN).

Roughness and texture

The microscopic and macroscopic roughness are characterized by the texture of the aggregate surface and by the overall roughness of the pavement surface due to protrusion of the aggregate surfaces, respectively. Macro- and microtextures are illustrated in Figure 13. Macrotexture has the great-

different minerals present in the aggregate (Tremblay et al. 1995).

The macroscopic roughness is provided by spacing between the aggregate from 0.5 to 50 mm (horizontal) and 0.2 to 10 mm (vertical) (Donbavand 1989). This spacing provides channels for rapid drainage of water from the surface and is important at vehicle speeds greater than 50 km/hr (Donbavand 1989). Therefore, at speeds higher than 50 km/hr, the skid resistance depends primarily on the spacing provided by the coarse aggregates (Beaton 1976).

The microtexture refers to the irregularities on

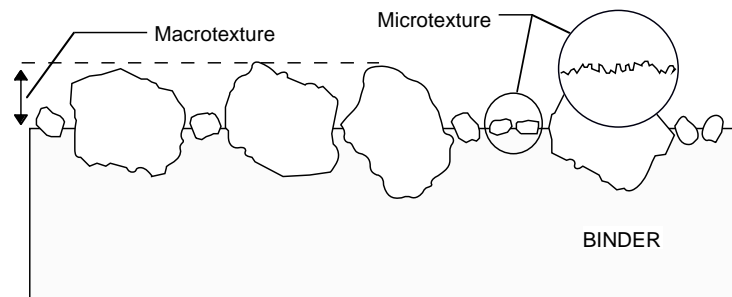

Figure 13. Road surfacing textural characteristics (Tremblay 1995).

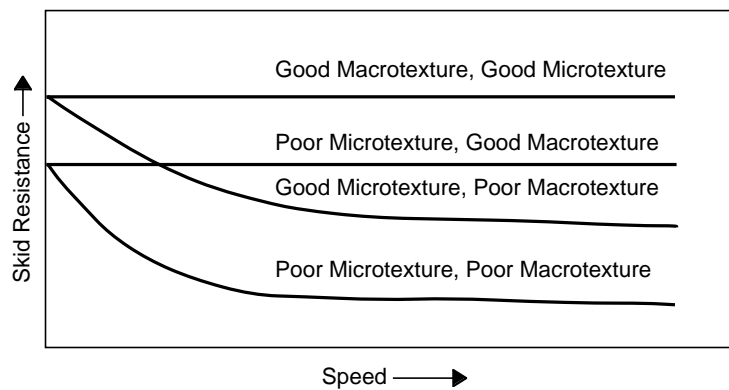

Figure 14. Correlation between macrotexture, microtexture, skid resistance, and speed (Tremblay 1995).

est influence on the change in friction with speed. Figure 14 illustrates the effect of the macro- and microtextures on skid resistance as a function of speed. Clearly, to maintain a constant high skid resistance value at various speed levels, the pavement surface has to have both good macro- and microtextures. The change in the texture depends on the aggregate resistance to fragmentation, wear, and polishing. Aggregate fragmentation and wear depend on the toughness and hardness of the aggregate minerals and the aggregate itself. Polishing depends on the difference in hardness of

the surface of the coarse and fine aggregates. It is also affected by the amount of fines in the HMA mix (Tremblay et al. 1995). The effect of different types of pavement surfaces on the macro- and microtextures is illustrated in Figure 15. The terms viscous and dynamic fluid pressure alleviation in Figure 15 relate to the natural flow and flow under the impact of a moving tire. The effect of texture on skid resistance is shown in Figure 16. Several observations can be made. First, the microtexture can provide adequate skid resistance at lower speeds, such as in urban areas (line



Pavement	Texture		Fluid Pressure Alleviation	
	Micro	Macro	Viscous	Dynamic
	Low	Low	Poor	Poor
	Low	Medium	Poor	Good
	High	Low	Excellent	Poor
	High	Medium	Excellent	Good
	Low	High	Fair	Excellent
	High	High	Excellent	Excellent
	Medium	High	Good	Excellent

Figure 15. Pavement surface characteristics.

3). However, it is important at all speeds and is a vital component for overall skid resistance. Second, the use of rounded coarse or fine aggregates results in low skid resistance values (sample 2 and 4 in Figure 16).

Several laboratory tests are available to study the change in macro- and microtextures under repeated loading in the laboratory. Methods for measuring texture can be categorized into volumetric, profile, topography, contact, drainage, and miscellaneous measurements (Rose et al. 1972). Brief descriptions of some of the tests are provided here. Details and references to these and other devices can be found in Rose et al. (1972).

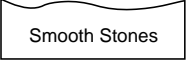
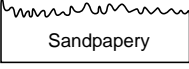
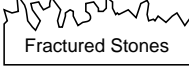
It must be realized that different test methods produce different results. It may not be possible to correlate results from one test to another. The most common test used today for determining the macrotexture depth is the sand patch test, described in the next subsection.

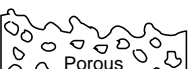
Volumetric measurements are commonly used for macrotexture depth determinations. These include the sand patch, modified sand patch, vibrating sand patch, sand track, grease smear, and silicone putty tests. These tests differ in the test materials and the patch geometry.

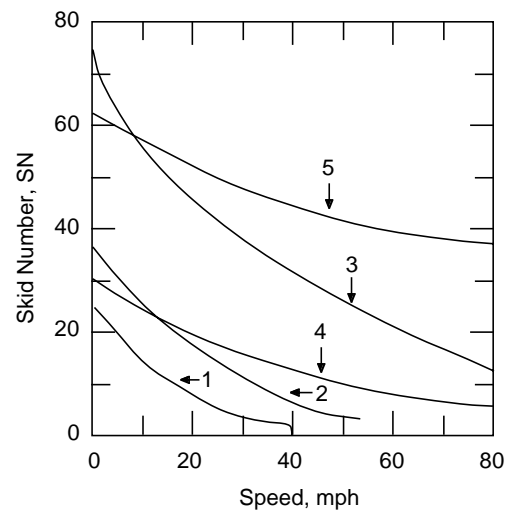





- 1  Smooth
- 2  Fine Textured, Rounded
- 3  Fine Textured, Gritty
- 4  Coarse Textured, Rounded
- 5  Coarse Textured, Gritty

Figure 16. Effect of pavement texture on skid resistance.

Profile measurement tests that could be adapted for the laboratory include the texturemeter, linear traverse, light, and wear/roughness meter tests. The texturemeter, developed by the Texas Transportation Institute, consists of a series of evenly spaced vertical parallels in a frame. With the exception of two, the rods can move vertically and are independent of one another. A string is attached to the movable end and to the frame. The texturemeter produces a straight line on a smooth surface and a dial indicator has been calibrated to zero. If there are any irregularities, the string produces a zig-zag line and results in a dial reading greater than zero. The reading is proportional to the coarseness of the macrotexture: the coarser the surface, the higher the reading.

Other methods that use microscopes and/or light are the linear traverse, light, and the wear and roughness meter. The linear traverse method developed by the Kansas Highway Commission uses a motorized lathe and a stereo microscope with the shaft of a potentiometer attached to the microscope focusing shaft. The specimen is moved transversely under the microscope. The operator keeps the surface under constant focus, thus changing the potentiometer voltage. This results in a tracing of the surface texture.

Surface texture can also be determined by light sectioning. In this method, a beam of light is passed through a slit at an angle. Based on the reflection of the light, the apparent profile height can be determined mathematically.

The wear/roughness meter also uses light to measure the mean wear height and mean texture. The data from this device provide a surface plot of maximum depth and distribution of the peaks of the observed surface. Details on this device can be found in Rosenthal et al. (1969).

Texture can also be quantified with topographic measurements of pavement surface using stereo photography. Pairs of photographs are taken



Figure 17. Containers of test materials for sand patch test.

using a specially designed camera. With the aid of a stereo comparator and a parallax bar, relative heights can be measured using stereo photos of successive points on the surface.

Other methods such as casting, molding, ink, and photographic emulsion prints have been used to obtain the surface texture. Detailed study of the magnified cast or print is then made in the laboratory.

Macrotexture characterization

Sand patch test

The sand patch test (ASTM E 965 1995) is used to assess the average macrotexture depth of a pavement surface. Values over 0.80 mm are considered excellent. Below 0.60 mm, the macrotexture is inadequate and can lead to extremely slippery conditions (Tremblay et al. 1995).

The test involves placing a known volume of material on the dry surface of the test specimen. Figure 17 shows the predetermined volume of test material in the container and test specimen. The test material is made from solid round glass spheres graded between the no. 60 and no. 80 sieves. This material is then spread into a circular patch with a disk (Fig. 18). The diameter of the patch is measured (Fig. 19). At least four measurements are made, and the average diameter is used to determine the average surface macrotexture depth ($MATX_d$). The macrotexture depth is calculated from the following equation:

$$MATX_d = \frac{4V}{\pi D^2} \quad (6)$$

where V is the test material volume and D is the average diameter of area covered by the test material.

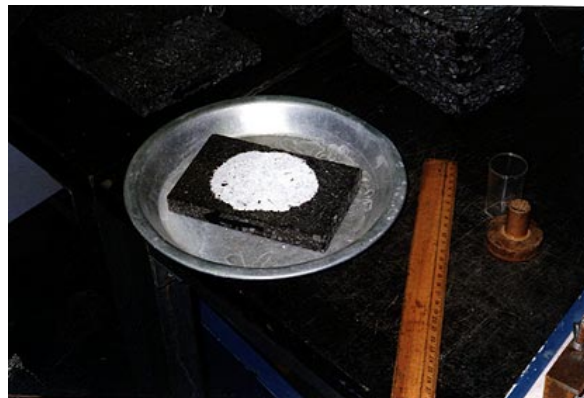

Figure 18. Circular patch of test material.



Figure 19. Measurement of diameter of sand patch.

Surface drainage test

The amount of time for a surface to drain can also be used as an indicator of the surface texture. A drainage meter (Moore 1966), 13 mm in diameter and 13 mm in height containing a known volume of water under atmospheric pressure, is placed on the pavement surface. A rubber ring is glued to the bottom of the cylinder and acts similarly to tire treads on the pavement surface. The amount of time taken for the water to flow out of the tank is related to the macrotexture of the pavement surface. High flow rates indicate high macrotexture depths.

Microstructure characterization

The change in the microstructure of a pavement surface is difficult to quantify and can be inferred from the changes in its frictional properties. This is done using an accelerated polishing device and a friction measurement system. The frictional prop-

erties of the pavement surface are usually determined in the laboratory using either the British portable skid resistance tester or the North Carolina State University variable-speed friction tester. Both these test methods are standardized by ASTM.

With respect to accelerated polishing, the tests are mostly done on wheel tracking systems. Examples of such tests are the small-wheel circular track wear and polishing machine, the Georgia skid tester, and the British polishing wheel. Some of these devices were fabricated by individual state DOTs or by universities and are not available commercially. The French have developed a polishing method using high-pressure water on a pavement surface. The equipment is less complex than the circular wheel and appears to correlate well with changes in the frictional properties due to polishing. The following discussion will start with the two friction testers currently standardized by ASTM followed by descriptions of several accelerated polishing devices.

Friction measurement devices

British portable skid resistance tester

The British skid resistance tester (BSRT) (Fig. 20), also called the British pendulum skid tester, can be used both in the laboratory and in the field. The tester consists of a pendulum that is free to swing through 180°. A rubber shoe slider is attached to the bottom end of the pendulum. In the position shown in Figure 20, the pendulum contains potential energy. When released, the potential energy is converted to kinetic energy that is dissipated by friction on the rubber shoe, which slides over the surface. A graduated scale on the pendulum registers the maximum swing

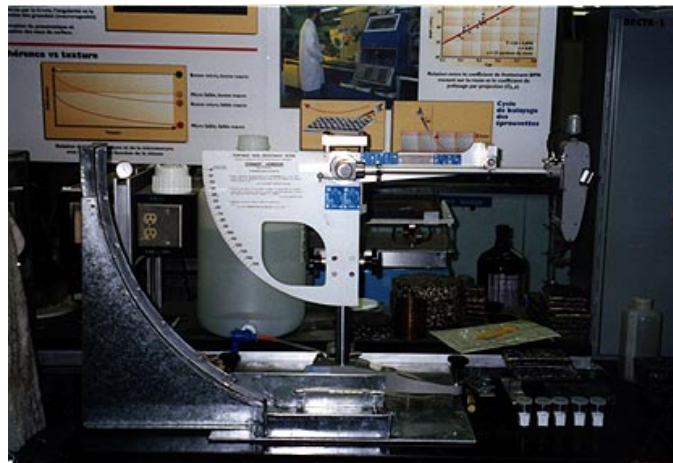

Figure 20. British portable skid resistance tester.

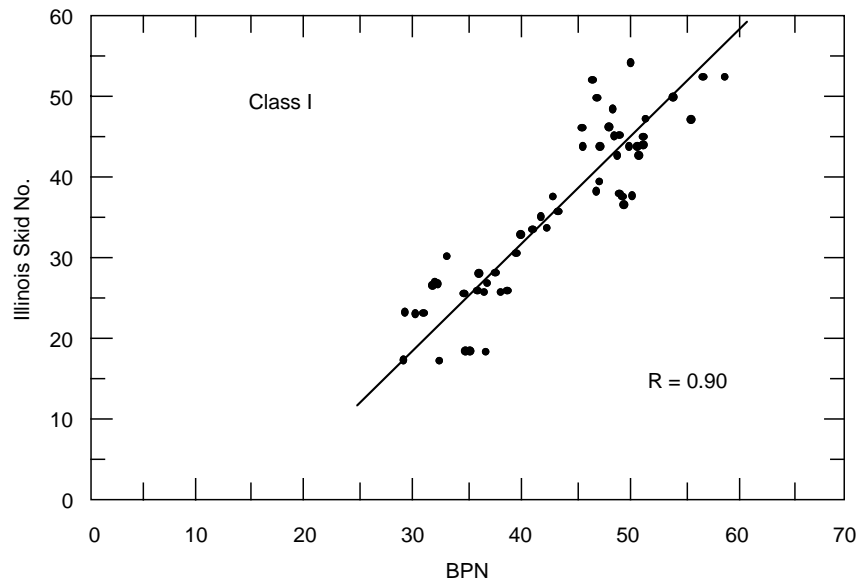

Figure 21. Relationship between British pendulum number and Illinois skid trailer number.

of the pendulum. Test method ASTM E 303 (1995), *Standard Test Method for Measuring Surface Frictional Properties Using the British Pendulum Tester*, uses the BSRT to measure the frictional properties of the microtexture.

The result from the BSRT is the British pendulum number (BPN), which relates well to skid numbers obtained in the field (Fig. 21). (The term Class I in Figure 21 refers to an Illinois DOT road classification system.) Sometimes, the BPN value is converted and reported as a polished stone value (PSV). The PSV value is the BPN value at the end of 6 hours of testing.

The advantages of this device are that it is portable, has a low initial cost, and can test in different orientations. Its disadvantages include that results from coarse macrotexture are questionable, it can only simulate low-speed skidding (780 m/hr), and it requires laborious calibration. To maintain consistency between different testers, a calibration process is used with a standard aluminum surface. Good agreement has been reported between two testers calibrated with this procedure.

NCSU variable-speed friction tester

The variable-speed friction tester (VST) is similar to the BSRT except that it has a locked-wheel smooth rubber tire at the bottom of the pendulum. It can also be used in the laboratory and in the field. One advantage of this device is that it can be used to simulate variable vehicle speed, something the British skid resistance tester can-

not. Another advantage of this device over the BSRT is that it can be used to determine the frictional properties of coarse and open graded mixes. As with the BSRT, this test has been standardized by ASTM under E 707-90 (1995).

As with the BSRT, the friction value is read from the scale and is presented as the variable

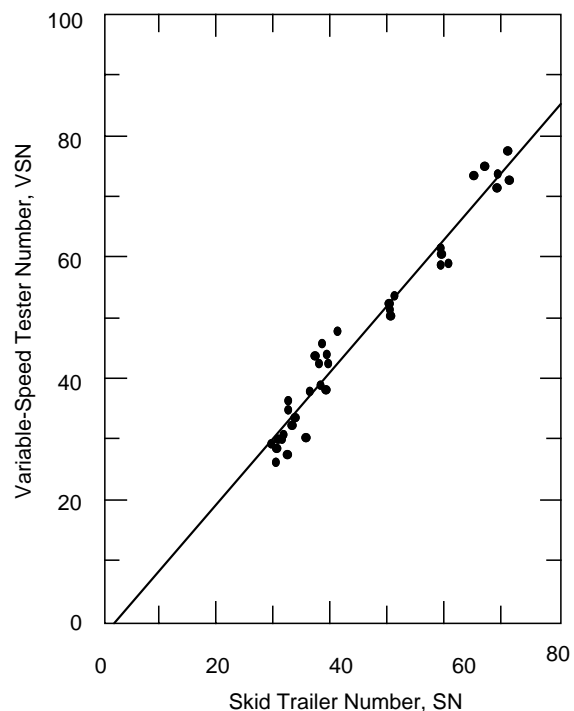

Figure 22. Correlation between variable-speed number and skid trailer number at 40 mph.

speed number (VSN). The VSN relates well to the skid numbers collected from the field (Fig. 22). This device is not as commonly available as the BSRT.

Polish–wear testing devices

With respect to testing, five characteristics need to be evaluated for selection of skid-resistant aggregates: texture, shape, mineral constituents, chemical composition, and gradation (Beaton 1976). The shape (angularity) of the aggregates can be determined with the tests discussed in the previous section. Mineral constituents can be determined from petrographic analysis. Tremblay et al. (1995) concluded that aggregate type (mineral constituents) plays a significant role in maintaining skid resistance and that the skid resistance from limestone/dolomite aggregates tends to wear quickly and thus decrease rapidly. Volcanic aggregates also showed low but stable resistance to skidding, but their resistance to wear was high, and pavement surfaces with these type of aggregates tended to maintain their macrotexture over time. Sandstone made from quartz, feldspar, and clay minerals showed the highest resistance to polishing. Marek (1972) came to similar conclusions and reported ‘polish resistant’ aggregates included siliceous gravels, granites, diabase, quartzite, sandstones, and expanded shales. This corresponds to the hardness of the minerals that comprise these rocks.

The mineral constituents give information on the wear-polish characteristics of the aggregates and in turn on the texture of the pavement surface. However, if used alone, the information has to be indexed to field performance. The acid insoluble test (ASTM D 3042 1995) can also be used to characterize the wear-polish characteristics of limestone aggregates, which can exhibit skid resistance ranging from extremely slippery to very good (Marek 1972) due to their mineralogical and textural properties. The interpretation and use of the test results are controversial (Beaton 1976), however, and the acid insoluble test is recommended for laboratory evaluation and not as a primary indicator of wear-polish.

Currently, NHDOT uses the Los Angeles abrasion test to evaluate the wear characteristics of HMA aggregates. This test is described in AASHTO T-96-94 (1998), *Standard Test Method for Resistance to Degradation of Small Size Coarse Aggregate by Abrasion and Impact in the Los Angeles Machine*. It involves placement of a known weight of material in a drum. Several steel spheres of known weights

are placed in the drum together with the aggregates. The drum is then rotated, and the steel ball creates an impact load on the aggregates. After 500 revolutions, the material finer than the no. 12 sieve is weighed and any loss is noted. The L.A. abrasion number is the percent passing the no. 12 sieve. No standard value is mandated, and most states tend to limit it to 40. The L.A. abrasion number does not correlate well with field performance. High values for slag and limestone aggregates have been generated from this test, and pavements constructed with these aggregates have shown good performance in the field.

British Accelerated Wear and Polishing Device

The British Accelerated Wear and Polishing Device (BAWPD) was designed to accelerate wear and polish of a pavement surface under a pneumatic tire approximately 20 cm in diameter at an inflation pressure of 310 kPa. The speed of the tire is approximately 420 m/hr (Fig. 23).

Fourteen aggregate test specimens are mounted on a 41-cm-diameter and 6-cm-wide wheel. One drawback with this method is that the



Figure 23. British wear and polishing device.

samples are curved and need to be made manually. The wheel is pressed onto the surface with a normal load of 391 N. It usually takes about 6 hr to complete the test. The tire is free to rotate on its axis and is driven by the friction between the grit and the pavement samples. Coarse grit is used to accelerate the wear and fine grit to accelerate polishing. Water is used to wet the pavement surface. Additional details on the test equipment and procedure can be found in the British standard procedure BS 812 (British Standards Institution 1989).

Small-wheel circular track polishing machine

The small-wheel circular track polishing machine is similar to the BAWPD discussed above (ASTM E 660 1995), but the track is in the horizontal plane and can hold up to 12 circular, 15-cm-diameter test specimens. The test track is 91 cm in diameter and has four smooth wheels driven at a rate of 30 rpm around the test track. This device is currently being updated by North Carolina State University. Instead of a circular track, the device will be a linear track.



Figure 24. Water projection device.

Projection method

A new accelerated polishing method using high-pressure water was developed jointly by Laboratoire des Chaussées of the Ministère des Transport du Québec (MTQ) and the French Laboratoire Ponts et Chaussées (LRPC). This method uses high-pressure water (10 MPa) and a fine abrasive pointed at an angle of 40° to the pavement surface. The sample is placed on a table that is computer-controlled to move in increments of 0.25 mm in the XY direction (Fig. 24). The water and abrasive are collected in the chambers below the test device. The fine abrasive is recycled for future testing. The sample is 150 mm by 100 mm (Fig. 25) and can be manufactured mechanically using a rolling wheel compactor or a kneading compactor. The test takes 3 hr per sample.

The sample is removed and its friction properties are determined using the British skid resistance tester. The frictional properties obtained from the tester are identified as the polishing by projection coefficient (C_{pp}). Figure 26 shows a reasonable relationship between the C_{pp} and on-road BPN values.



Figure 25. Specimen for projection method.

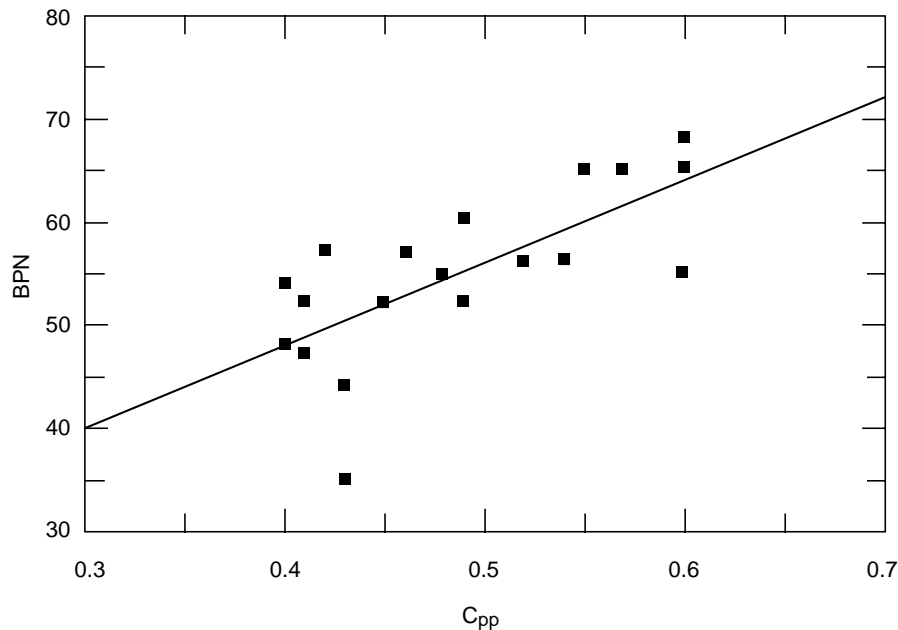

Figure 26. Correlation between on-road British pendulum number and polishing by projection coefficient C_{pp} (Tremblay 1995).

Summary of test equipment

In summary, the British skid resistance tester is commonly used to characterize the changing frictional properties of pavement surface. In the U.S., laboratory-accelerated polishing tests are uncommon. The frictional values (BPN) are related to field measurements of skid number. In other countries, such as Canada, laboratory accelerated tests on aggregates are routinely conducted using the British wear and polish device or using the projection method (in Quebec).

EVALUATING FROST RESISTANCE OF PAVEMENT AGGREGATES

The durability of aggregate depends on the amount of water that freezes within it and on its ability to resist and/or accommodate the resulting expansion. Thus, durability is related to pore volume—more precisely to pore size distribution—and to the aggregate’s modulus. Typically, only those pores that are narrow enough to absorb water and at the same time are large enough that water can freeze at normal temperatures are the problem.

Numerous tests have been proposed over the years to study the durability of construction materials exposed to freezing and thawing, but pavement performance is still the best measure of aggregate quality. This section reviews testing procedures for those most closely related to test-

ing and selecting aggregates for use in cold regions pavements and identifies where additional research is needed.

Soundness test

Most highway departments rely on the sulfate soundness test to determine the frost resistance of aggregate. This is one of the earliest laboratory tests used to predict the durability of aggregates; it was mentioned in the 1800s and, after some modifications, it has become today’s AASHTO T 104 (1990) (ASTM C 88 1981). Aggregates are repeatedly soaked in either sodium sulfate or magnesium sulfate solutions and are then dried in an oven. The test simulates the expansive force of water freezing within the aggregate pores by growing sulfate crystals in the pores.

The appeal of this test is its simplicity and the speed at which it can be conducted. The major problem is that it does not duplicate the freezing process in rock. Crystal growth during oven drying creates internal expansion that can dilate the aggregate, but the internal stresses that develop due to freezing water are not solely related to crystal (ice) growth. A major cause of stress during freezing is hydraulic pressure produced by water expelled from the freeze front due to expansion of the ice against the pore walls. Moreover, it is well known that the temperature at which water freezes within any porous material varies with the size of the pore: the smaller the

pore, the lower the freezing temperature. Since aggregate includes a range of pore sizes, not all pores freeze at one temperature, whereas in the sulfate test, all pores, regardless of size, experience expansive forces caused by crystal growth. Consequently, the mechanism of internal destruction caused by the sulfate soundness test does not duplicate that of natural freezing. The literature contains examples of aggregate that failed the sulfate test but performed well in service and vice versa.

Unconfined freeze–thaw test (AASHTO T 103)

Modern refrigeration equipment provides an alternative to the sulfate soundness test for measuring aggregate durability. This equipment was first used to test the aggregate in an unconfined condition; that is, not confined within concrete mixtures as it is normally found. Traditionally, unconfined freeze–thaw tests have either evaluated the damage caused by a certain number of freeze–thaw cycles or they have determined the number of freeze–thaw cycles needed to cause a certain amount of damage. The basic procedure, AASHTO T 103 (1990), is to subject aggregate to repeated cycles of freezing and thawing. Variations on this procedure have included vacuum saturation of aggregate, as opposed to merely submerging the aggregate in water; alcohol–water, as opposed to water, as the wetting medium to aid penetration of pores; soaking the aggregate in salt solutions, as opposed to just water, to increase frost damage; and varying the freezing and thawing rates. Despite these and other variations on the freeze–thaw test procedure, the results obtained by unconfined freezing and thawing of aggregate have not always provided good correlation to service life.

The problem is that freezing unconfined aggregate is not the same as freezing aggregate confined in concrete. Though the freezing process is the same in either case, the interaction between the aggregate and its immediate surroundings creates the difference between the two testing conditions. As ice forms in a pore of an aggregate, the approximate 9% volume change that accompanies this process squeezes unfrozen water against the walls of the pore. This hydraulic pressure, in the case of unconfined aggregate, can be handled if the aggregate can elastically deform, or if the water can escape into a nearby empty void or to the outside boundary of the aggregate. For confined aggregates, the outside pressure relief depends on the ability of the concrete

matrix to absorb the escaping water into empty pores. In addition, even if the aggregate can dilate without cracking, pavement damage can only be avoided if the pavement matrix can also expand without cracking. Thus, aggregate that can elastically accommodate water frozen within its pores could show no effect from unconfined testing but could show considerable damage when tested in concrete if the concrete matrix was relatively impermeable or if it was unable to accommodate the dilation of the aggregate. Aggregate that wets by capillarity may take on more water when exposed to a free water surface than when confined in a pavement, particularly if the matrix has smaller pores than those in the aggregate, in which case water will be preferentially absorbed by the matrix. In this case, the aggregate would likely suffer more damage when tested unconfined than when tested confined.

Confined rapid freeze–thaw test (ASTM C 666 A and B)

A popular test procedure for evaluating the frost durability of concrete and aggregate is ASTM C 666 (1990) and its many variants around the world. It consists of two methods: method A, which freezes and thaws concrete in water, and method B, which freezes concrete in air and thaws it in water. One freeze–thaw cycle lasts from 2 to 5 hr, and the test can last up to 300 or more cycles. The correlation between this test and field performance has not always been good. The major weakness with this test is a very rapid cooling rate compared with that in nature. The hydraulic pressures that might be caused by a relatively slowly advancing freeze front in nature are probably much lower than the unrealistically fast-moving freeze fronts caused by this test. Another objection to this test is that up to 5 months can pass before results are available. Though this test has several shortcomings, it will continue to be popular until a better method is available.

Hydraulic fracture test

Recently, a new test was developed to simulate the hydraulic forces generated by freezing water inside aggregate without having to freeze the aggregate. In this test, aggregate submerged in water is subjected to high pressures. Upon sudden release of the pressure, air compressed within the pores forces water to flow away from the pore in much the same way as freezing causes unfrozen water to flow away from a freeze front. The fact that this creates very rapid pressure changes and

that the entire aggregate is pressurized, as opposed to only freezing sites, suggests that this test could be quite different from natural freezing. Generally, aggregates that can withstand more than 100 pressure cycles are quite durable, and those that produce fracture in 5% of the aggregate particles in less than 50 pressure cycles tend to exhibit poor frost resistance. Though this test has shown reasonable correlation to field performance in limited testing, more experience is needed to assess it.

Cryogenic test

The cryogenic test (Korhonen and Charest 1995) examines the efficacy of cycling aggregate between hot water and liquid nitrogen. Modified from AASHTO T 103 (1990), the test consists of immersing water-saturated aggregate in liquid nitrogen for about 1 minute followed by a 2-minute immersion in hot water. Within 10 freeze–thaw cycles, aggregates susceptible to frost damage are readily identified. The test, however, is not capable of ranking aggregates of moderate to good performance.

Slow freeze test (ASTM C 671)

It has been documented that cooling rates in the field rarely exceed a few degrees per hour, but the ASTM C 666 (confined rapid freeze–thaw) test subjects concrete to much higher cooling rates. ASTM C 671 (1981), on the other hand, consists of cooling concrete at a rate of -2.8°C per hour. The specimens are held in a 2°C bath for two weeks before being frozen. Though this test has shown good correlation with field performance, it is very time consuming.

VPI single-cycle freeze test

In the VPI single-cycle freeze test, a concrete beam is subjected to -18°C air while length change and temperature are measured over a 4-hr period. The test is rapid compared with ASTM C 671 (1981) and has been successful in identifying very durable and nondurable aggregate. Other testing is needed to rank aggregates of moderate durability.

Iowa Pore Index test

The Iowa Pore Index test acknowledges the importance of pore size in aggregate durability. It consists of measuring the amount of water that enters aggregate submerged in water when pressurized to 241 kPa. The amount of water absorbed during the first minute of the test is con-

sidered to be a measure of the beneficial voids in the aggregate. A second reading, taken after 15 minutes, indicates the relative portion of voids that are frost susceptible. Large amounts of secondary water indicate that the aggregate is susceptible to frost damage. This test seems to give good correlation to ASTM C 666 (1990) results, though there is not always a good correlation with field performance.

Assuming that the first minute represents beneficial voids appears to be a shortcoming of this test. In nature, the first pores to fill with water are those that are small enough to exhibit capillarity. The larger “beneficial” voids, provided they are not connected to the surface, will not fill with water unless they are under hydrostatic pressure (or gravity drainage). Thus, a 24-hr soak followed by additional wetting under pressure should be investigated as a modification to this test.

In summary, the experience of transportation officials, pavement engineers, researchers, and others is that, whether aggregates are confined within Portland cement concrete (PCC) or within asphalt cement concrete (ACC) pavements, they are not always immune to damage caused by cold weather. D-cracking, a common distress in PCC pavements, is the disintegration of coarse aggregates by frost action, and stripping, a common distress in HMA pavements, is the disbonding of coarse aggregates from the asphalt matrix during cold weather. Both deterioration mechanisms lead to pavement damage whose root cause appears to be excessive volume changes caused by the freezing of saturated aggregate. When water freezes inside particles of rock, the tendency is for the rock to expand, which can be great enough to crack the pavement matrix or to rupture the aggregate or both.

Currently, the best way to measure volume expansion of aggregate is when it is confined within concrete. In this manner, stresses from hydraulic forces within discrete particles of aggregate and those from water escaping from the aggregate into the surrounding matrix are accounted for. However, this test is time-consuming—making, curing, and testing specimens requires considerable effort—and does not always correlate to field performance.

A simpler method is to measure the volume expansion of unconfined aggregate. Though this is different from being confined in concrete, it would identify those aggregates that expand unusually or that expel a large amount of water. It would also avoid the variabilities associated with

consistency in fabricating laboratory specimens, and it would measure an important response mechanism of aggregate to freezing. Sneck et al. (1972) and Davison (1982) describe such a test. They placed rock particles into a glass container fitted with a calibrated tube and filled with alcohol, and they observed that the volume of alcohol abruptly changed each time the container was cooled below the freezing point of water. It does not appear that this test was pursued any further. Another variation is to consider freezing aggregate in alcohol while it is suspended from a scale. Any volume change should be noted as a change in weight.

SUMMARY AND RECOMMENDATIONS

Hot-mix asphalt aggregates play a significant role in controlling pavement distresses such as rutting, skid resistance, and freeze-thaw deterioration. This report provides a state-of-the-art summary of existing and new, promising laboratory test methods and devices for characterizing the aggregate.

Several laboratory tests for rutting were identified, ranging from sophisticated image analysis to determination of flow time of aggregates. The NAA uncompacted void value test appears to be simple and has been found to correlate well with aggregate shape, angularity, and texture. The flow time index method used by the Quebec Ministry of Transportation also appears to show great promise as a simple tool for evaluating the same properties.

The macro- and microtexture of the pavement surface appears to control the skid resistance of the pavement surface. The sand patch test is commonly used to characterize the macrotexture of the pavement surface.

The frictional properties of microstructure are determined using frictional testers. The most common one is the British skid resistance tester. The wear and polishing characteristics of the aggregates can be determined by several wheel polishing devices. Quebec MOT uses high-pressure water projection to conduct accelerated polishing, and friction results from the test appear to correspond well to those obtained from the British pendulum number.

For freeze-thaw durability, aggregate expansion was identified as the major contributor to pavement frost damage. A variation to the expansion measurement of unconfined aggregate described by Sneck et al. (1972) and Davison

(1982), appears to be a quick and simple approach to indexing aggregates based on propensity to expand during freezing.

LITERATURE CITED

AASHTO T 85-85 (1998) *Specific Gravity and Absorption of Coarse Aggregate*. Washington D.C.: American Association of State Highway Transportation Officials.

AASHTO T 96-94 (1998) *Standard Test Method for Resistance to Degradation of Small Size Coarse Aggregate by Abrasion and Impact in the Los Angeles Machine*. Washington, D.C.: American Association of Highway Transportation Officials.

AASHTO T 103-83 (1990) *Standard Method of Test for Soundness of Aggregates by Freezing and Thawing*. Washington D.C.: American Association of State Highway Transportation Officials.

AASHTO T 104-86 (1990) *Standard Method of Test for Soundness of Aggregate by Use of Sodium Sulfate or Magnesium Sulfate*. Washington D.C.: American Association of State Highway Transportation Officials.

Aldrich, A.C. (1996) Influence of aggregates gradation and particle shape/texture on pavement deformation of hot-mix asphalt pavements. U.S. Army Corps of Engineers, Waterways Experiment Station, Technical Report GL-96-1.

ASTM C 88-76 (1981) *Standard Test Method for Soundness of Aggregates by Use of Sodium Sulfate or Magnesium Sulfate*. Annual Book of ASTM Standards, Part 14. Philadelphia: American Society for Testing and Materials.

ASTM C 127-88 (1995) *Standard Test Method for Specific Gravity and Absorption of Coarse Aggregate*. Annual Book of ASTM Standards, Part 14. Philadelphia: American Society for Testing and Materials.

ASTM C 666-84 (1990) *Standard Test Method for Resistance of Concrete to Rapid Freezing and Thawing*. Annual Book of ASTM Standards, Part 14. Philadelphia: American Society for Testing and Materials.

ASTM C 671-77 (1981) *Standard Test Method for Critical Dilation of Concrete Specimens Subjected to Freezing*. Annual Book of ASTM Standards, Part 14. Philadelphia: American Society for Testing and Materials.

ASTM C 1252-93 (1995) *Standard Test Methods for Uncompacted Void Content of Fine Aggregate (as Influenced by Particle Shape, Surface Texture, and Grading)*. Annual Book of ASTM Standards, Part 14. Philadelphia: American Society for Testing and Materials.

- ASTM D 3042-92** (1995) Standard test method for insoluble residue in carbonate aggregates. *Road and Paving Materials; Pavement Management Technologies*, **04**(03).
- ASTM E 274-90** (1994) Standard test method for skid resistance of paved surfaces using a full-scale tire. *Road and Paving Materials; Pavement Management Technologies*, **04**(03).
- ASTM E 303-93** (1995) Standard test method for measuring surface frictional properties using the British Pendulum Tester. *Road and Paving Materials; Pavement Management Technologies*, **04**(03).
- ASTM E 660-90** (1995) Standard practice for accelerated polishing of aggregates or pavement surfaces using a small-wheel, circular track polishing machine. *Road and Paving Materials; Pavement Management Technologies*, **04**(03).
- ASTM E 707-90** (1995) Standard test method for skid resistance measurements using the North Carolina State University variable-speed friction tester. *Road and Paving Materials; Pavement Management Technologies*, **04**(03).
- ASTM E 965-87** (1995) Standard test method for measuring the macrotexture depth using a volumetric technique. *Road and Paving Materials; Pavement Management Technologies*, **04**(03).
- ASTM E 1551-93a** (1994) Standard specification for special purpose, smooth-tread tire, operated on fixed braking slip continuous friction measuring equipment. *Road and Paving Materials; Pavement Management Technologies*, **04**(03).
- Barksdale, R.D., and S.Y. Itani** (1994) Influence of aggregate shape on base behavior. *Transportation Research Record*, **1227**: 171–182.
- Beaton, J.L.** (1976) Providing skid resistant pavements. *Transportation Research Record*, **622**.
- British Standards Institution** (1989) Testing aggregates. BS 812.
- Davison, J.I.** (1982) Volume change due to freezing in plastic masonry mortar. In *Masonry: Materials, Properties, and Performance* (J.G. Borchelt, Ed.). American Society for Testing and Materials, ASTM STP 778, p. 27–37.
- Donbavand, J.** (1989) Skidding resistance of road surfaces—Implications for New Zealand. Road Research Unit, Transit New Zealand, Wellington, New Zealand, Road Research Unit Bulletin 81.
- Horne, W.B.** (1974) Elements affecting runway traction. SAE paper 740496, p. 29.
- Hosking, J.R., and G.C. Woodford** (1976) Measurement of skidding resistance, Part II. Factors affecting the slipperiness of a road surface. TRRL Report 738, 1976.
- Huang, E.Y.** (1962) A test for evaluating the geometric characteristics of coarse aggregate particles. *Proceedings, American Society of Testing and Materials*, **62**: 1223–1242.
- Ishai, I., and E. Tons** (1971) Aggregate factors in bituminous mixture designs. University of Michigan, Ann Arbor, Report 335140-1-F.
- Ishai, I., and E. Tons** (1977) Concept and test method for a unified characterization of the geometric irregularity of aggregate particles. *Journal of Testing and Evaluation*, **5**(1): 3–15.
- Janoo, V.C.** (1990) Use of soft grade asphalts in airfields and highway pavements in cold regions. USA Cold Regions Research and Engineering Laboratory, Special Report 90-12.
- Janoo, V.C.** (1998) Quantification of shape, angularity, and surface texture of base course materials. USA Cold Regions Research and Engineering Laboratory, Special Report 98-1.
- Kandhal, P.S., and F. Parker, Jr.** (1998) Aggregate tests related to asphalt concrete performance in pavements. National Cooperative Highway Research Program, Transportation Research Board, NCHRP Report 405.
- Korhonen, C., and B. Charest** (1995) Assessing cryogenic testing of aggregates for concrete pavements. USA Cold Regions Research and Engineering Laboratory, Special Report 95-4.
- Krumbein, W.C.** (1941) Measurement and geological significance of shape and roundness of sedimentary particles. *Journal of Sedimentary Petrology*, **11**(2): 64–72.
- Lees, G.** (1964) The measurement of particle shape and its influence in engineering materials. *Journal of the British Granite and Whinestone Federation*, London, **4**(2): 1–22, 1964.
- Marek, C.R.** (1972) Review, selection and calibration of accelerated wear and skid resistance testing equipment. Illinois Cooperative Highway Research Program, University of Illinois at Urbana-Champaign, Interim report – Phase 1, Project IHR-406.
- Moore, D.F.** (1966) Prediction of skid-resistance gradient and drainage characteristics for pavements. *Highway Research Record*, **131**: 181–203.
- Michigan DOT** (1983) Evaluation of the straight line gradation chart and the particle index test. Research Report No. R-1210.
- Rose, J.G., J.W. Hutchinson, and B.M. Gallaway** (1972) Summary and analysis of the attributes of methods of surface texture measurements. In *Proceedings, Symposium on Skid Resistance of Highway Pavements*, ASTM.
- Rosenthal P., F.R. Haselton, K.D. Bird, and P.J. Joseph** (1969) Evaluation of studded tires, perfor-

mance data and pavement wear measurements. National Cooperative Highway Research Program, Highway Research Board, Report 61,

Shergold, F.A. (1953) The percentage of voids in compacted gravel as a measure of its angularity. *Magazine of Concrete Research*, **5**(13): 3–10.

Sneck, T., et al. (1972) Winter masonry, building technology and community development. Technical Research Centre of Finland, Publication 1, Helsinki.

Tons, E., and W.H. Goetz (1968) Packing volume concepts for aggregates. *Highway Research Record*, **236**: 76–96.

Tremblay, G., S. Julien, A. Leclerc, and B. Auger

(1995) The role of aggregates in road surfacing texture and skid resistance. In *Proceedings, Transportation Association of Canada, Victoria, British Columbia*.

Uge, P., and P. Van de Loo (1974) Permanent deformation of asphalt mixes. *Canadian Technical Asphalt Association*, **29**: 307–342.

Wilson, J.D., L.D. Klotz, and C. Nagaraj (1995) Automated measurement of aggregate indices of shape. Federal Highway Administration Report FHWA RD-95-116.

Wright, P.J.F. (1955) A method of measuring the surface texture of aggregate. *Magazine of Concrete Research*, **7**(21): 151–160.

REPORT DOCUMENTATION PAGE

Form Approved
OMB No. 0704-0188

Public reporting burden for this collection of information is estimated to average 1 hour per response, including the time for reviewing instructions, searching existing data sources, gathering and maintaining the data needed, and completing and reviewing this collection of information. Send comments regarding this burden estimate or any other aspect of this collection of information, including suggestions for reducing this burden to Department of Defense, Washington Headquarters Services, Directorate for Information Operations and Reports (0704-0188), 1215 Jefferson Davis Highway, Suite 1204, Arlington, VA 22202-4302. Respondents should be aware that notwithstanding any other provision of law, no person shall be subject to any penalty for failing to comply with a collection of information if it does not display a currently valid OMB control number. PLEASE DO NOT RETURN YOUR FORM TO THE ABOVE ADDRESS.

1. REPORT DATE (DD-MM-YY) December 1999		2. REPORT TYPE		3. DATES COVERED (From - To)	
4. TITLE AND SUBTITLE Performance Testing of Hot-Mix Asphalt Aggregates				5a. CONTRACT NUMBER	
				5b. GRANT NUMBER	
				5c. PROGRAM ELEMENT NUMBER	
6. AUTHOR(S) Vincent C. Janoo and Charles Korhonen				5d. PROJECT NUMBER	
				5e. TASK NUMBER	
				5f. WORK UNIT NUMBER	
7. PERFORMING ORGANIZATION NAME(S) AND ADDRESS(ES) U.S. Army Cold Regions Research and Engineering Laboratory 72 Lyme Road Hanover, New Hampshire 03755-1290				8. PERFORMING ORGANIZATION REPORT NUMBER Special Report 99-20	
9. SPONSORING/MONITORING AGENCY NAME(S) AND ADDRESS(ES) New Hampshire Department of Transportation				10. SPONSOR / MONITOR'S ACRONYM(S)	
				11. SPONSOR / MONITOR'S REPORT NUMBER(S)	
12. DISTRIBUTION / AVAILABILITY STATEMENT Approved for public release; distribution is unlimited. Available from NTIS, Springfield, Virginia 22161.					
13. SUPPLEMENTARY NOTES					
14. ABSTRACT Hot-mix asphalt (HMA) pavements are subject to thermal cracking, fatigue cracking, rutting, stripping, raveling, and freeze-thaw damage. Some of these distresses are directly affected by the choice of aggregates. Particle shape, surface texture, particle size, pore structure, and particle strength are the most common characteristics cited for controlling rutting and for maintaining adequate skid resistance. A literature review was conducted to evaluate commonly used and potential test methods for evaluating hot-mix aggregates in term of pavement performance.					
15. SUBJECT TERMS Aggregates Hot-mix asphalt Rutting Freeze-thaw Laboratory testing Skid resistance					
16. SECURITY CLASSIFICATION OF:			17. LIMITATION OF OF ABSTRACT	18. NUMBER OF PAGES	19a. NAME OF RESPONSIBLE PERSON
a. REPORT UL	b. ABSTRACT UL	c. THIS PAGE UL			19b. TELEPHONE NUMBER (include area code)
				27	

[to contents](#)