



THE STATE OF NEW HAMPSHIRE
DEPARTMENT OF TRANSPORTATION



Victoria F. Sheehan
Commissioner

William Cass, P.E.
Assistant Commissioner

Bureau of Environment
Tel. (603) 271-3226
Fax (603) 271-7199

April 30, 2020

Michael Hicks
US Army Corps of Engineers
Regulatory Branch
696 Virginia Road
Concord, MA 01742-2851

Re: Individual Section 404 updated Permit Application Materials
Derry-Londonderry, 13065 (Exit 4A)

Dear Mr. Hicks:

Forwarded herewith is the Individual Section 404 updated Permit Application materials in response to the New Hampshire Department of Environmental Services (NHDES) Request for More Information prepared by Normandeau Associates, Inc. and Fuss & O'Neil, Inc. for the NH Department of Transportation (NHDOT). The Towns of Derry and Londonderry, and the NHDOT, in cooperation with the Federal Highway Administration (FHWA) are proposing the discharge of dredged or fill material into Waters of the United States for the purpose of construction of a new interchange on I-93 (known as Exit 4A), and other transportation improvements to reduce congestion and improves safety along NH Route 102.

A complete project description is included within the previously submitted permit application.

This response to NHDES's RFMI includes a Comprehensive Report stamped by licensed Professional Engineer and Certified Wetland Scientist (in the State of New Hampshire), Final Plans Stamped by licensed Professional Engineer, Final Coordination with New Hampshire Natural Heritage Bureau (NHNHB) and New Hampshire Fish and Game (NHFG), Trolley Car Lane Stream Resource Classification and Description, Impact Assessment, Mitigation Goals and Approach, Stream Restoration Design, Plans, Narrative, Hydrologic and Hydraulic Modeling summary of analyses showing Net Balance of Flood Storage, Stream Construction Methodology, Photographs / Photo Stations, Stream Restoration / Re-Establishment Monitoring Plan, Stream Grading Plan, Planting Plan, Wetland Impact Plans showing that the impacts have not changed for the project and Erosion Control plans.

The final Environmental Impact Statement and FHWA Record of Decision are available at: <http://www.i93exit4a.com/documents.aspx>. The response to NHDES's RFMI is available electronically at: <https://www.nh.gov/dot/org/projectdevelopment/environment/units/program-management/wetland-applications.htm#D>.

Sincerely,

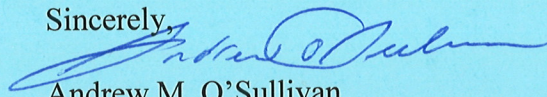

Andrew M. O'Sullivan
Wetlands Program Manager
Bureau of Environment

Enclosures

cc: Town of Derry (via certified mail)
Town of Londonderry (via certified mail)
Karl Benedict, NHDES (via E-mail)
Beth Alafat and Jean Brochi,, EPA (via E-mail)
Maria Turr, USF&WS (via E-mail)
Carol Henderson, NHF&G (via E-mail)
Keith Cota, NHDOT (via E-mail)
Marc Laurin, NHDOT (via E-mail)

S:\Environment\PROJECTS\DERRY\13065\Wetlands\4302020 RFMI Response to NHDES\Individual ACOE 04-30-2020.docx

RESPONSE TO NHDES REQUEST FOR MORE INFORMATION
NHDES # 2018-03134

TROLLEY CAR LANE STREAM RELOCATION
LONDONDERRY, NEW HAMPSHIRE



Submitted to:
NEW HAMPSHIRE DEPARTMENT OF TRANSPORTATION
BUREAU OF ENVIRONMENT

APRIL 2020



FUSS & O'NEILL



<p>SHANNON REED BEAUMONT No. 12527 LICENSED PROFESSIONAL ENGINEER - STATE OF NEW HAMPSHIRE -</p> <p><i>Shannon Beaumont</i> 4/29/20</p>	<p>KRISTEN A. HAYDEN No. 13142 LICENSED PROFESSIONAL ENGINEER - STATE OF NEW HAMPSHIRE -</p> <p><i>Kristen Hayden</i> 04/29/2020</p>	<p>LEE E. CARBONNEAU No. 123 CERTIFIED WETLAND SCIENTIST - STATE OF NEW HAMPSHIRE -</p> <p><i>Lee E. Carbonneau</i> 4/29/20</p>
---	--	---

For Hydraulics

For Hydrology

For Wetlands

Prepared by: Fuss and O'Neill, Inc. and Normandeau Associates, Inc.

RESPONSE TO NHDES REQUEST FOR MORE INFORMATION
NHDES # 2018-03134

TROLLEY CAR LANE STREAM RELOCATION

LONDONDERRY, NEW HAMPSHIRE

NHDES has requested the submittal of additional information to complete the review of the Exit 4A Londonderry-Derry Project (NHDES # 2018-03134). The requested items include:

- **Final plans** with a PE stamp
- **Final Coordination with NHB and NHFG** regarding recommendations for the species listed per NHB19-3453
- Timeframe for 30-day RFMI review **Time Extension Agreement** necessary by March 15, 2020
- **Trolley Car Lane stream resource classification**

In addition, NHDOT and NHDES have agreed to a **mitigation approach** for the Trolley Car Lane stream relocation that requires an ARM fund payment in an amount to be determined after post-construction monitoring. This has been adjusted based on the stream resource classification.

This agreement is also dependent on **stream restoration design and plans**, which are being submitted with this RFMI response. NHDES has requested that the stream channel reconstruction design address the following elements:

- Bank full width
- Entrenchment Ratio
- Sinuosity
- Net floodplain
- Existing forested buffer
- Native planting plan
- Stream bed simulation material
- Longitudinal profile and grading plan
- Accommodate perpendicular tributary flows to Trolley Car stream
- Accommodate for any increased flow volume due to additional impervious (BFW/ER)
- Methodology of stream reconstruction

NHDES has also requested a Trolley Car Lane **Stream Restoration/Re-establishment Monitoring Plan**.

These highlighted items are addressed below and in attachments as noted (in approximate order).

1.0 Final Plans with a PE stamp

Final plans stamped by a Professional Engineer are included with this submittal as a separate file/attachment.

2.0 Final Coordination with NHB/NHFG

Correspondence with the New Hampshire Natural Heritage Bureau and New Hampshire Fish and Game Department is provided in **Attachment A**. In accordance with the request from NHFG, the following notes have been added to the plan set:

- Contact NHFG immediately if state threatened or endangered species are encountered during site surveys or during project construction. Melissa Doperalski 603-479-1129 or NHFG Wildlife Administration at 603-271-2461. Photographs of animals should be taken if feasible to help in identification.
- All erosion control materials will be wildlife-friendly, made from natural woven fibers (no plastic mesh products) without fixed knots and without welded plastic components.
- If the species Nuttall's reed grass (*Calamagrostis cinnoides*), or any other listed species, is identified within the project area, please complete a rare species reporting form and document the population using GPS, then contact NHB. If plants are found within the project area but outside of impact areas, contact NHB to discuss whether installation of protective orange fencing during construction may be warranted.

The remaining recommendations are expected to be included in the wetland permit conditions and will be adhered to by the contractors. The species profile sheets in Appendix A for black racers, spotted turtles, and Blanding's turtles will be provided to the contractors and construction monitors for assistance in identifying and reporting protected species.

3.0 Timeframe for 30-day RFMI review Time Extension Agreement necessary by March 15, 2020

A Time Extension Agreement is being provided by NHDOT separately and is not included in this document.

4.0 Trolley Car Lane Stream Resource Classification and Description

The construction of the Exit 4A ramps and sound walls on the western side of I-93 will require the relocation of Stream S1, also known as The Trolley Car Lane stream/Wheeler Brook, and will partially fill in Wetland 14, through which S1 flows. Stream S1 enters the project area from the north within a forested wetland (Wetland 14), and flows in and out of this wetland on its way south between I-93 and Trolley Car Lane until it passes through a culvert under I-93 near the Ash Street/Pillsbury Road bridge and outlets approximately 1,200 feet south of Ash Street on the east side of the highway. From I-93, the stream flows east under Londonderry Road and continues south into Wheeler Pond. Portions of the stream appear to have been previously relocated and channelized, probably when I-93 was originally constructed. The Northern section in Wetland 14 is braided, flowing among rocks and hummocks in several channels, before coalescing into a single channel with several intermittent tributaries from the east and west.

Approximately 1,700 linear feet of stream S1 will be impacted and will be relocated to accommodate sound walls for I-93 and the new Exit 4A interchange ramp. This was addressed in the Exit 4A FEIS and state and federal wetland permit applications submitted in 2020 and 2018, respectively. These documents identify S1 as entirely intermittent within the project area, based on observations of dry conditions during the field surveys and previously collected data in NHDOT project files. Upon analysis of additional existing data and review of new data, NHDES, NHDOT and Normandeau agreed that the northern impacted segment of 603 linear feet should be considered intermittent, and the stream below this location (1100 linear feet of impact) is perennial. This finding is supported by the size of the watershed (0.69 square miles) as determined through StreamStats, a watershed size which is typically consistent with perennial streams; channel dimensions and current understanding of stream hydrogeomorphology; and other project-related documents that identified the stream as perennial. This reclassification of a portion of the stream as perennial will affect the calculation of stream impacts and mitigation requirements for the Exit 4A project, as described in Section 5.0 below. A walk along the length of the stream within the project area was also conducted in 2020 to photo-document current stream conditions. Photo-documentation of the stream channel as it appeared in April 2020 is provided in **Attachment B**.

5.0 Impact Assessment, Mitigation Goals and Approach

Impacts are proposed along 1,703 linear feet of stream S1, located east of Trolley Car Lane along the proposed Exit 4A SB off-ramp, for stream relocation. The state and federal wetland applications for the Exit 4A project included ARM fund calculations for mitigation of wetland, vernal pool, and stream impacts. The impacts associated with Stream S1 were not included in the stream ARM fund calculator, as its relocation was assumed to be self-mitigating, with final design to be provided by the Design-Build team. Upon review of the wetland permit application materials, NHDES has now determined that the relocated/restored stream may be considered partially self-mitigating if certain conditions are met. First, the design must meet as many of the design criteria identified in Table 3-1 of the Normandeau stream survey report as possible, plus some additional requirements (outlined in Section 6.0 below). Further, the Trolley Car Lane Stream Restoration shall be monitored in accordance with the NHDES Mitigation Program Stream Restoration/Re-establishment Monitoring Plan (Monitoring Plan, **Attachment C**) dated April 28, 2020 to determine if it is successful.

The associated final stream compensatory mitigation value is \$739,285 (see Table 1 for details). If NHDES determines the stream relocation has been successfully completed in accordance with the Monitoring Plan, then a 50% credit will be applied towards compensatory mitigation. A balance total of \$369,643 would be submitted to the Aquatic Resource Mitigation (ARM) fund within 120 days following notification by NHDES to the NHDOT. If the project has not successfully completed stream relocation plan parameters after three years of monitoring, then a balance of \$739,285 shall be submitted to the Aquatic Resource Mitigation (ARM) Fund within 120-days of notification from NHDES.

Exit 4A In-Lieu Fee Summary

As calculated in Exhibit D - Mitigation of the 2020 NHDES Wetland Permit Application, there is no change to the direct or secondary impacts or In-Lieu-Fee calculations for vegetated wetlands and vernal pools.

The total In-Lieu-Fee quantity due upon Governor and Council (G&C) approval of the Design-Builder’s contract, \$3,769,086.39, has not changed. However, as noted above, an additional ARM fund payment for stream S1 relocation will be required after three years of post-construction monitoring. If the relocation/restoration is deemed successful, the additional fee will be \$369,643. If it is determined to be unsuccessful, the additional fee will be \$739,285 as shown in Table 1.

Table 1. Exit 4A Proposed In-Lieu Fee Summary

Resource	Impact Quantity	In Lieu Fee Estimate	Assumptions
All Wetlands	210,643 sf (4.84 acres)	\$1,061,965.82	Includes direct impacts to wetlands/vernal pools in accordance with NHDES Rules Wt 800.
Secondary Impacts “Edge Effects”	89,298 sf (2.05 acres)	\$450,199.74	Mitigation for secondary “Edge Effects” are calculated as recommended in the 2016 USACE Mitigation Guidance.
Vernal Pools Loss	286,000 sf (6.57 acres)	\$1,441,881.41	Mitigation for functional loss of 4 medium and 1 high value vernal pool based on ratios recommended in 2016 USACE Mitigation Guidance
Vernal Pools - Secondary	78,000 sf (1.79 acres)	\$393,240.38	For partially or indirectly impacted vernal pools, modeled to drop in value
Streams	1,703 lf	\$421,799.04	Impacts to channels of streams and banks of perennial streams in accordance with NHDES Rules Wt 800.
INITIAL TOTAL		\$3,769,086.39	Due upon G&C approval of Design-Builder’s Contract
S1 –Successfully Restored*	2,803 lf	+\$369,643 or	For impacts to Stream S1 –if successful after 3 years of monitoring
S1 –Restoration Unsuccessful*	2,803 lf	+ \$739,285	For impacts to Stream S1 –if unsuccessful after 3 years of monitoring

*Stream S1 ARM fund payment was calculated by NHDES as follows:

603 LF of Intermittent (x1) stream channel= \$159,040

1100 LF of perennial (x3) stream channel – 1/3 for stream bed simulation = 2200 LF = \$580,245

Total = \$739,285

50% if parameters are met after 3-years of post-construction stream relocation monitoring

\$369,643

As previously noted in the 2020 Wetland Application, stream mitigation ARM fund contributions may be further reduced by the costs associated with stream culvert replacement(s) project(s) that are determined to qualify for the Stream Passage Improvement Program (SPIP). These evaluations are to be conducted by DOT in consultation with DES to determine the appropriate stream crossing(s) to mitigate.

6.0 Stream Restoration Design and Plans

Stream surveys were conducted by both Normandeau Associates, Inc. (in 2010) and NHDOT Bureau of Environment (in 2013), and are attached to the Exit 4A NHDES state wetland permit application as Attachment B. The approximate stream cross-section locations at which channel morphology in Table 3-1 were surveyed in these two studies are shown on Figure 1. The approximate locations of the intermittent and perennial segments as now classified for the Exit 4A project are also shown in Figure 1.

Table 3-1. Stream Assessment Table 3-1. Morphological characteristics of the upper, middle and lower reaches of the west stream in wetland complex 14¹

	Upper Interm.	Middle Interm.	Lower Perenn.	Delineative Criteria	
Morphological Characteristic	Reach	Reach	Reach	B Type	E Type
Bankfull Width (ft)	5	6.4	10.8		
Mean Depth (ft)	1.05	0.69	0.59		
Bankfull Cross-Section Area (sq. ft)	5.25	4.4	6.42		
Width/Depth Ratio	4.8	9.3	18.3	>12	<12
Maximum Depth (ft)	1.4	0.89	0.96		
Width of the Flood Prone Area (ft)	150*	25.1	21.7		
Entrenchment Ratio	30*	3.9	2.01	1.4 - 2.2	>2.2
Channel Materials (D50 in mm)	0.0625	0.0625	2.5		
Water Surface Slope	0.005	Dry	0.015	.02 - .039	<.02
Channel Sinuosity	1	1.05	1.04	1 - 1.2	>1.5
Stream Type	E5	E6	B4		

Delineative criteria from Rosgen (1996). Values with * are estimated.

In Figure 1, the blue stars represent approximate locations of the Normandeau stations associated with the upper, lower and middle reaches where metrics in Table 3-1 were recorded (in 2010). The Middle Intermittent Reach data in Table 3-1 was collected from the intermittent reach that must be relocated. (The Upper Reach in Table 3-1 shown at the upper blue star is upstream and outside of the impact area). The Lower Perennial reach data was collected from the perennial segment that will be relocated.

¹ From Table 3-1 in Normandeau Associates, Inc. November 2010. I-93 Exit 4A Interchange Study, Derry-Londonderry, Final Environmental Impact Statement, Stream Relocation Assessment and Conceptual Restoration Plan.

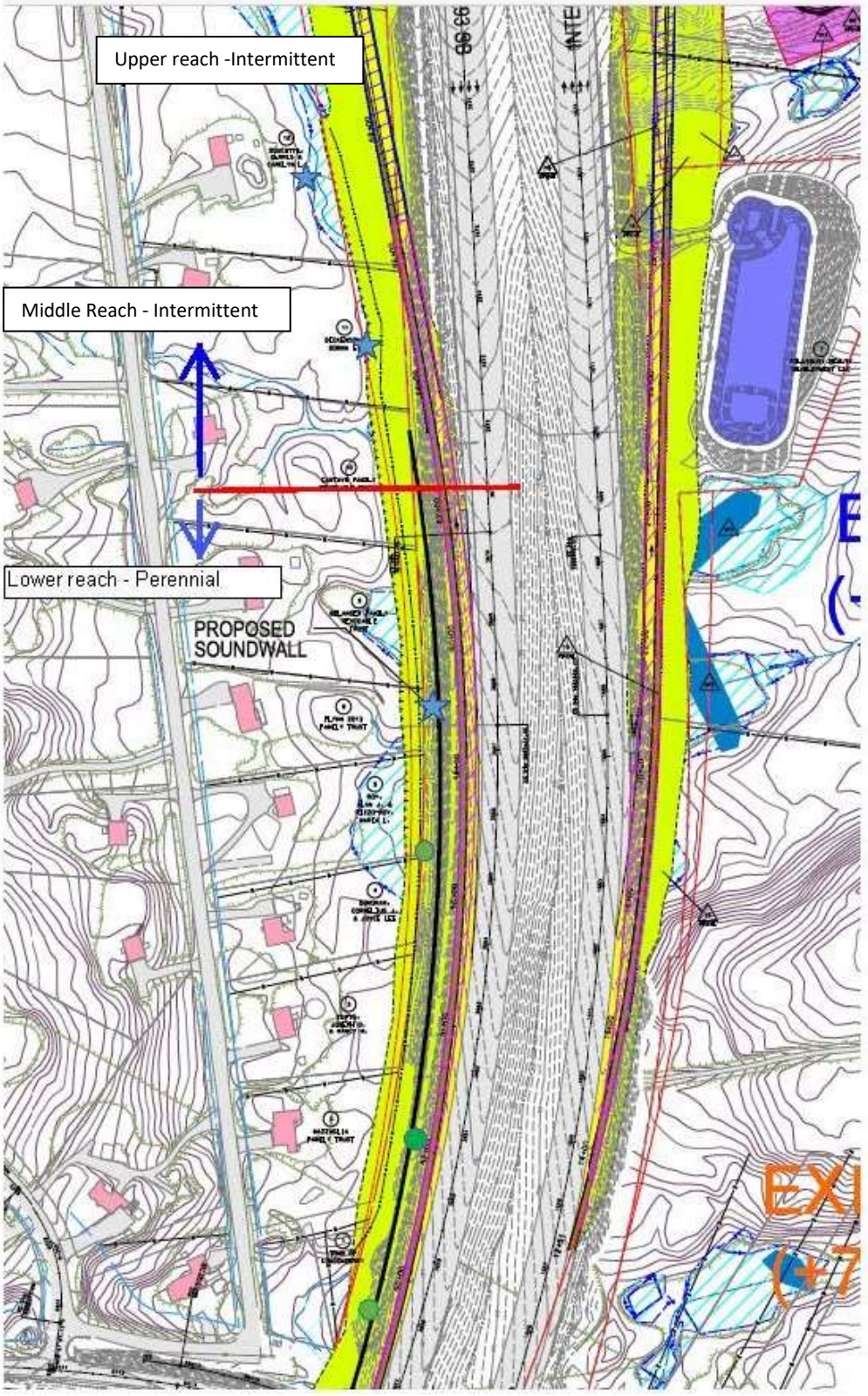

Figure 1. Trolley Car Lane stream (S1) survey locations and segment classification

The green circles correspond to the NHDOT Sections 1, 2, and 3 (north to south) in 2013², also within the perennial reach to be impacted. NHDOT recommendations for the relocated segment based on averages at their sample stations was 10' bankfull width; max channel depth of 1.6 ft. These recommendations are consistent with the Lower Perennial station measured by Normandeau. Channel materials in this perennial reach vary between sand and muck in the slow run and pool locations to gravel and cobble in the riffle and fast run segments.

The information requested by NHDES relevant to the stream relocation/restoration design are described below.

Restoration Design Requirements

Per the Monitoring Plan, the NHDOT and/or the Design-Build team will design as many of the following parameters into the restoration plans as possible:

- Proposed morphological parameters in accordance with Normandeau Assoc. Stream Assessment Table 3-1 (above). Incorporate as many parameters as possible in design for each reach section
- Account for peak volume and peak flow at stream outlet point, due to reduced wetland storage (vs. potential net gain for floodplain creation)
- Design accounts for perpendicular tributary flows
- Include native vegetated stream buffer along constructed portions of stream channel,

The design plans will include;

- Longitudinal profile and cross-section plan
- Net balance of wetland/flood storage area
- Comparison of existing vs. proposed to determine metrics achieved
- Planting plan identifying native plantings along the stream buffer of constructed stream sections
- Methodology of construction (includes timing, proposed stream bed simulation materials installation, dewatering methods, planting install timeframes, etc.)

The Restoration Design Narrative (Section 3.0) describes the stream restoration elements.

A stream restoration grading plan, with relevant notes, is attached (**Attachment D**). The information requested by NHDES relevant to the stream relocation/restoration design are described below.

6.1 Stream Restoration Design Narrative

The construction of the Exit 4A ramps and sound walls on the western side of I-93 will require the relocation of Stream S1 and partial fill in Wetland 14, through which S1 flows. The wetland and stream impacts associated with this portion of the project design were included in the state and federal wetland permit applications for the Exit 4A project. The project has now been redesigned with steeper fill slopes (from 2:1 to 1.5:1) to provide additional room within the existing ROW for stream restoration. This also has the effect of reducing direct wetland impacts in Wetland 14. Wetland impacts associated with

² Bureau of Environment. 10/07/2014. Stream Crossing Assessment Report. Project: I-93 Northern Segment (Stream Relocation Sta 43662+00 to 43670+00 SB "Trolley Car Lane".

stream construction will match impact reductions associated with reduced slope fill, resulting in a net zero change in wetland impacts. Design plans for stream restoration are being submitted with this RFMI response.

Hydrologic Modeling

Peak Volume and Peak Flow

To determine the Pre- and Post-Development runoff conditions, the SCS TR-20 methodology was applied to the site with calculations performed by the software HydroCAD™ (Version 10.0), as developed by Applied Microcomputer Systems. The Post-Development HydroCAD™ model completed by Parsons Brinckerhoff (PB) for the 14633D/14633I contracts was used to determine the Pre-Development runoff conditions for the Exit 4A improvements in the vicinity of the Trolley Car Lane stream for the purposes of comparing peak flows. In addition, the Pre-Development HydroCAD™ model completed by Parsons Brinckerhoff (PB) for the 14633D/14633I contracts was used as the Pre-Development conditions for the purposes of the hydraulic modeling and flood storage evaluation. The original stream assessment completed by Normandeau in 2010 was prior to the I-93 project construction; and therefore it was felt that this was a more appropriate comparison. **Note: Models prepared by PB were used as provided by NHDOT as the final approved models for the I-93 project, and are not part of the analyses prepared and provided by Fuss & O'Neill.**

The Post-Development runoff conditions were determined by adjusting the Pre-Development catchment areas based on the proposed Exit 4A grading and drainage. For areas outside of transportation related impervious, which was adjusted based on proposed edge-of-pavement or the soundwall berm, weighted average CN values by catchment were assumed to remain unchanged. For catchments containing the transportation related impervious areas, CN values were adjusted to account for the additional impervious area. Ponds within the model were also adjusted to account for the impacts from the Exit 4A project. Certain portions of the proposed project will be captured and drain to other drainage structures outside the watershed of the area of study.

All hydrologic models account for the flows from minor tributaries which contribute to the stream watershed. Within the study reach in particular there are three tributaries which enter from the west side, and three tributaries flowing through three culvert crossing locations from east of I-93 to the stream channel. These locations have been shown on the stream grading plan.

Within this watershed, three separate detention areas have been utilized to mitigate the loss of flood storage and attenuate flows as a result of the I-93 and Exit 4A projects; existing B1670, proposed B1012 and a modified detention basin on Seasons Lane. B1670 modeling was updated to ensure that both treatment of the WQV and flood storage of the 50-year event could be provided within the existing basin. B1012 was sized to provide infiltration of the entire 50-year event. The existing detention basin on Seasons Lane was increased in size to provide additional detention of the 50-year event. At the point of interest (inlet of node 286-287 "Existing 60" RCP under Ash St.") the inflow runoff volume (50-year 24-hour storm) has decreased from 73.71 ac-ft (Pre I-93) / 70.96 ac-ft (Post I-93/Pre Exit 4A) to 70.22 ac-ft (Post Exit 4A) and the inflow peak runoff decreased from 152.63cfs (Post I-93 / Pre Exit 4A) to 152.04cfs (Post Exit 4A). Below is a summary table (Table 2) of the flows along the Trolley Car Lane Stream for Pre I-93, Post I-93 and Post Exit 4A. The delta column shows the change from Post I-93/Pre

Exit 4A to Post Exit 4A. The HydroCAD™ Routing Diagram for the Post Exit 4A model and a plans depicting the location of the flows below are included in Attachment E for reference. Full hydrologic models are available upon request.

Table 2. SUMMARY OF PEAK FLOW (CFS) 50-YEAR DESIGN STORM				
ANALYSIS POINT	50-YEAR			Δ
	PRE I93	POST I93	POST Exit 4A	
Inlet to 60" RCP	171.18	152.63	152.04	-0.59
Pond 7 (53+00)	165.34	150.15	149.69	-0.46
Pond 6 (55+75)	160.00	144.47	138.80	-5.67
R14 (60+00)	133.50	117.44	111.47	-5.97
R4 (61+00)	124.48	114.34	105.11	-9.23
Pond 3 (66+00)	106.51	96.42	87.57	-8.85

Hydraulic Modeling

Development of the Existing Hydraulic Model

The Corp of Engineers Hydrologic Engineer Center’s (HEC’s) HEC-RAS River Analysis System was utilized to develop the existing and proposed hydraulic models for this project. The river modeling software GeoHECRAS was utilized to help develop the models (software by CivilGEO, Inc.). This program completely supports HEC-RAS within a 2D and 3D GIS environment. The Pre I-93 surface, clipped to encompass the study area, was imported into the GeoHECRAS program. Channel sections were cut within the GeoHECRAS program to allow a seamless transition from the surface model to the development of the cross-sections for the hydraulic model. As the Pre I-93 surface did not include channel information, additional surveyed cross-sections were obtained at an approximately 100-foot spacing along the length of Stream S1. This survey was then utilized to incorporate the stream channel into the channel sections.

The HEC-RAS program utilizes a Step-Backwater Analysis method. The program calculates energy losses as a result of channel slope and roughness. The existing channel was run utilizing the Pre I-93 flows for the 50-year design flood. The upstream and downstream boundary conditions were based on the normal depth slope of the upstream and downstream reaches. Characteristic Manning’s roughness coefficients of 0.048 for the channel, 0.10 for the west overbank densely wooded areas, and 0.10 for roadway side slope overbank areas, which are still densely vegetated, were selected. The model was run utilizing a mixed flow regime to account for differences in flow types along the length of the channel.

Development of the Proposed Hydraulic Model

As part of the requirements to consider the relocated Stream S1 self-mitigating, the stream should meet as many of the existing morphological stream characteristics as defined in Table 3-1. In order to match the Stream S1 longitudinal slope, the relocated channel was required to be the same length as the existing channel. This would ensure that the overall relocated stream water surface profile would match existing. This new channel was also developed to ensure that each segment of the stream was also as close to the same length as possible. However, the new channel geometry was limited by the available space available between the toe of slope of the Exit 4A ramp roadway embankment and the existing limit of work/right-of-way. Therefore, additional sinuosity had to be provided in the upper portion of the relocated stream to accommodate the required channel length within that section of the reach.

The thalweg elevations along the length of existing Stream S1 were tabulated and plotted on an Excel XY scatter chart. The chart identified three distinct sections of the channel. These sections were broken out into three separate charts; one each for the lower, middle, and upper reaches. The trendline feature in Excel was utilized to determine an average longitudinal channel slope for each section. The channel geometry (bankfull width and mean depth) was developed utilizing Table 3-1. The developed upper reach is equivalent to the observed middle intermittent section of the stream as defined in the table, and the developed middle reach is equivalent to the observed lower perennial section of the stream as defined in the table. The developed lower reach was outside the limits of the original study and is not identified in the table. The geometry for this section of the stream was therefore based on replicating the existing stream geometry as defined by the surveyed cross-sections. The overbank areas were developed to create as much new storage within the space available and still tie back into the existing topography.

Similar to the existing model, the upstream and downstream boundary conditions were based on the normal depth slope of the upstream and downstream reaches. Characteristic Manning's roughness coefficients of 0.045 for the channel, 0.10 for the west overbank densely wooded areas, and 0.04 for roadway side slope overbank areas, which will be revegetated as part of this project but will have very limited storage and steep slopes, were selected. The model was run utilizing a mixed flow regime to account for differences in flow types along the length of the channel. A few small ineffective flow areas were used to model the "dead storage zones" within the floodplain that are disconnected from the main channel. These areas do not contribute to the conveyance characteristics of the channel.

Net Balance of Flood Storage

Although the affected reach of the Trolley Car Lane stream does not flow through a FEMA-mapped floodplain, the functional floodplain will be partially filled for Exit 4A construction, and the flood storage potential of the adjacent wetlands will be reduced.

In an effort to capture the amount of floodplain storage loss as a result of the 4A construction, the storage volume of the existing conditions model for the length of Stream S1 below the 50-year design flood event was determined. HEC-RAS provides the flow area at each cross section. Average end area calculations were determined and multiplied by the length of the channel between the cross-sections to determine the storage volume between each segment of the stream, and then added together to

determine the total storage volume within the affected reach. The HEC-RAS model does not provide an easily defined “flood prone width” location; therefore we utilized the 50-year information easily extracted from HEC-RAS sections. Since the “flood prone width” location based upon 2x the bankfull depth will be lower than the 50-year flood elevation, this method is conservative.

The proposed storage was calculated similarly to the existing storage. However, as most of the proposed 50-year design flood event water surface elevations are lower than existing, the additional proposed flood storage available between the proposed water surface elevation and the existing water surface elevation needed to be calculated. HEC-RAS provides the top width of the flow at each cross section. This width was multiplied by the difference between the existing and proposed water surface elevations at each cross section to come up with the additional storage area, which was then added to the flow area for the proposed model to come up with a total storage area at each cross section.

The difference between the existing (Pre I-93) and proposed storage volume is approximately 1720 cubic yards (46,350 CF).

As noted in the hydrologic modeling section above, additional flood storage has been provided in three detention locations: B1670 (154,900 CF), B1012 (25,500 CF) and expanded detention basin on Seasons Lane (added 10,100 CF). These storage areas are above the water quality volume (WQV) required for treatment. Since these basins provide significant additional storage and attenuate the peak flows and volumes below the Pre I-93 conditions, no additional flood storage is proposed.

Channel Morphology

Longitudinal profile and cross-section plan

The water surface elevations for the existing and proposed hydraulic models were compared. At all but two cross-sections, the proposed water surface elevations were the same or lower than existing. The two cross-sections that showed higher proposed water surface elevations were located just upstream and downstream of the confluence with a perennial stream, and the increase in water surface elevations were contained within the limit of work/right-of-way, resulting in no increase in flooding on abutting properties as compared to the Pre I-93 Stream S1.

To ensure that the water surface slope of the proposed channel still met the slope requirements, the water surface elevations as provided by HEC-RAS were tabulated and graphed similar to the process utilized to identify the proposed channel bed slopes. Chart 1 below shows the existing water surface slope as compared to the proposed.

Chart 1. Existing versus proposed water surface profile

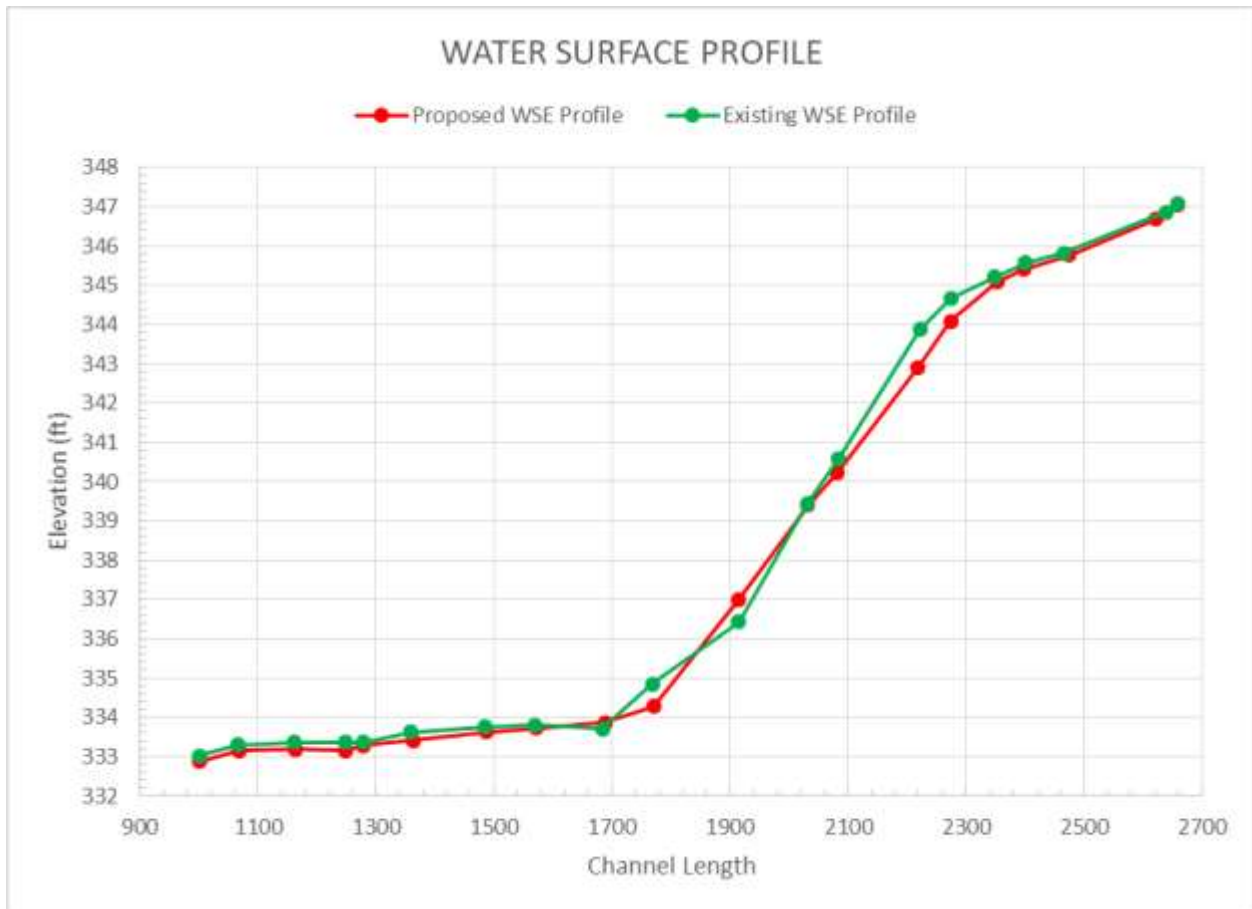

Comparison of existing vs. proposed to determine metrics achieved

Table 3 (Table 3-1 Revised) below has been modified to include the proposed channel morphology and compares the proposed stream restoration design to the stream morphological parameters in Normandeau’s Table 3-1 from the 2010 stream assessment report. The northern (intermittent) reach of designed Stream S1 (Station 23+52 to 26+59) is designed to meet the morphological conditions of the existing middle intermittent stream channel reach in Table 3-1 to the extent possible. The portion of Wetland 14 through which this reach is currently dispersed in braided sections will be partially filled for the construction of the Exit 4A ramps, so the intermittent stream channel will be confined to one channel. Meanders are designed to replace sinuosity to the extent possible within the available construction area. The southern (perennial) portion of the designed stream (Station 17+70 to 23+52) compares to the observed lower perennial stream channel reach in Table 3-1. The lowest portion of the designed channel (Station 10+00 to 17+70) was not included in the original study and was therefore not included in the Table 3. This section of the channel was designed to match the existing morphological characteristics as taken from survey and recent site reconnaissance.

It should be noted that for simplicity of modeling and construction, the delineation between the middle intermittent and lower perennial portion of the stream for the proposed hydraulic and channel design was based on the change in water surface slope of the channel rather than the location identified on Figure 1.

Table 3 (Table 3-1 Revised): Design vs Observed Stream Morphology Parameters

	Observed Middle Intermittent	Designed Middle Intermittent	Observed Lower Perennial	Designed Lower Perennial
Morphological Characteristic	Reach		Reach	
Bankfull Width (ft)	6.4	6.4	10.8	10.8
Mean Depth (ft)	0.69	0.69	0.59	0.59
Bankfull Cross-Section Area (sq. ft)	4.4	3.5	6.42	5.68
Width/Depth Ratio	9.3	9.3	18.3	18.3
Maximum Depth (ft)	0.89	0.69	0.96	0.59
Width of the Flood Prone Area (ft)	25.1	32.3	21.7	29.6
Entrenchment Ratio	3.9	5.0	2.01	2.7
Channel Materials (D50 in mm)	0.0625	1.0	2.5	2.5
Water Surface Slope	Dry	0.006	0.015	0.019
Channel Sinuosity	1.05	1.36	1.04	1.03
Stream Type	E6	E5	B4	B4

It should also be noted that the bankfull cross section area as provided in the observed reaches was a simple calculation of bankfull width times mean depth. The designed bankfull cross section area is smaller only because it takes the channel slopes into account and calculates the trapezoidal shape of the channel.

The observed flood prone width as defined in Table 3 is based on field observations independent of a specific flood event. The proposed flood prone width was determined based on the limits of the floodplain geometry created as part of the proposed model channel geometry development. The proposed model attempted to capture as much storage as possible by creating level floodplains within the limits of property proposed to be acquired for the project. The resulting widths are slightly greater than existing, however, it is difficult to accurately compare the two values as they were determined in very different ways. A slight increase in sinuosity is also identified within the middle intermittent reach as described above to accommodate the required channel length within the available limits of work.

For the intermittent reach, the channel material D50 has been sized to provide stability for the channel section. It is anticipated that over time, finer materials will be deposited within the reach. The designed intermittent stream has been reclassified as an E5 stream based on this material gradation.

In summary, the majority of the morphological characteristics of the proposed channel are as close to the existing characteristics as possible. It should be noted that modifications to the channel geometry may be required to stay within the construction limits at some locations.

Grade control features within the new channel will be required within the limits of the Stream S1 observed riffle pool locations. Additional grade control features will be required at the slope change locations identified in Chart 1 above. These locations are identified on the grading plan, but extend from approximately Station 22+75 to 23+52 and Station 17+70 to 20+82 within in the middle intermittent reach, and from Station 11+64 to 13+62 and Station 10+00 to 10+50 within the lower reach outside the limits of the original study. The grade control features shall be cobble, log, or rock weirs, and shall extend approximately 6 inches above the riverbed elevation.

Conclusion

The proposed channel was designed to recreate the existing morphological features of the channel as closely as possible and maintain as much flow storage as possible. The volume of flow has decreased as compared to existing and water surface elevations have been lowered almost everywhere. In those locations the proposed water surface elevations are higher, the additional volume is contained within the limits of property proposed to be acquired for the project. Therefore, no increase in flood stages on abutting properties will be encountered from the proposed design. Flow and sediment transport characteristics will not be affected in a manner that could adversely affect channel stability and surface water quality based on the drainage area contributing to Stream S1 and the associated wetland areas at the stream culvert outlet pipe at Ash Street.

Re-vegetation Plan

The stream restoration design includes replanting of a native vegetated stream buffer along constructed portions of stream channel. The stated goal is to have a forested buffer on each side of the relocated stream, as currently exists. The stream channel will meander between the toe of the fill slope and the edge of the ROW, and all disturbed locations below the toe of the ramp/soundwall slopes will be restored. This area may be less than 5 ft wide on the east side of the stream in some locations. The disturbed land around the relocated stream channel will be revegetated with a combination of herbaceous and woody vegetation. The area of wetland to be restored is approximately 20,579 sf; and the area of upland to be restored is approximately 11,178 sf. Private property adjacent to the ROW to the west, which is currently forested, will not be disturbed and is expected to remain forested and function as a buffer.

The following planting plan (Table 4) has been developed to revegetate disturbed wetlands, uplands and streambanks as shown on the stream restoration grading plan in Attachment E.

Table 4. Plants for Stream S1 Streambanks/ Buffer Revegetation

Common Name	Scientific Name	Status	Spacing	Plant Size/Type	Quantity	Location
Red Maple	<i>Acer rubrum</i>	FAC	15-20 feet	3-6 ft/Potted/Salvaged	40	Wetland/Upland Buffer
Yellow birch	<i>Betula allegheniensis</i>	FAC	15-20 feet	3-6 ft/Potted/Salvaged	40	Wetland/Upland Buffer
Ironwood	<i>Carpinus caroliniana</i>	FAC	10-15 feet	3-6 ft/Potted/Salvaged	50	Wetland/Upland Buffer
Silky dogwood	<i>Cornus amomum</i>	FACW	3-6 feet	2-3 ft/Potted/Salvaged	250	Wetland/Upland Buffer
Speckled alder	<i>Alnus incana</i>	FACW	3-6 feet	2-3 ft/Potted/Salvaged	150	Wetland Buffer
Spicebush	<i>Lindera benzoin</i>	FACW	3-6 feet	2-3 ft/Potted/Salvaged	150	Wetland Buffer
Black elderberry	<i>Sambucus nigra</i>	FACW	3-6 feet	2-3 ft/Potted/Salvaged	150	Wetland Buffer
Black elderberry	<i>Sambucus nigra</i>	FACW	2-3 feet	Live stakes*	550	Streambank
Silky dogwood	<i>Cornus amomum</i>	FACW	2-3 feet	Live stakes*	550	Streambank
Pussy Willow	<i>Salix discolor</i>	FACW	2-3 feet	Live stakes*	550	Streambank
NE erosion control/restoration mix for moist sites ²			35lbs/acre	hydro-seed, broadcast	17 lbs	Wetland Buffer/Streambank
NE Erosion control/restoration mix for dry sites ²			35lbs/acre	hydro-seed, broadcast	9 lbs	Upland Buffer
Coir Logs for Streambank Stabilization				540	linear ft	Wetland Outer Streambank
Boulders for Steambank stabilization				290	linear ft	Upland Outer Streambank

* Live stakes are only available for purchase or cutting and installation in November-March

All plant quantities in the table above are approximate and may be revised in final design. To the extent possible and in compliance with the draft permit conditions provided by NHDES, existing desirable tree saplings and shrubs will be carefully salvaged from the construction area and cared for in a safe and shaded location until they can be replanted along the restored stream buffer. Native topsoil in locations that are free from invasive species may also be stockpiled and replaced within the buffer area to take advantage of the available seed bank these soils contain.

Live stakes will be installed along the immediate streambank approximately 2 feet apart in two offset rows, in pre-made holes that extend into the water table. These stakes can be installed in coir biologs, between streambank boulders, or directly in bank soil. Purchased and salvaged trees will be spaced without regard to species.

Purchased and salvaged shrubs can be planted in same-species clusters within uplands and wetlands.

Proposed stream bed simulation materials

The D50 of existing streambed materials in the intermittent reach is 0.0625 mm, corresponding to fine sand. In the perennial reach, the D50 is 2.5 mm (very fine gravel). Occasional boulders are also present in the perennial reach. Material to be replaced in the stream will be selected to match the particle gradation below, and existing material will be stockpiled and reused if possible.

Finished streambed materials in the intermittent reach shall have a D50 of approximately 1.0 mm and be as follows:

- 50% of very fine to medium sand (0.062 – 1.0 mm)
- 50% of coarse to very coarse sand (1.0 mm – 2.0 mm)

Finished streambed materials in the perennial reach shall have a D50 of approximately 2.5 mm and be as follows:

- 25% of fine and very fine sand (0.062-0.25 mm)
- 20% of coarse to very coarse sand (0.25 – 2.0 mm)
- 45 % of gravel (2.0 – 64.0 mm)
- 10% of cobble (64 – 180 mm)

Stream restoration materials (bioengineering, stone, large woody debris)

Selected bioengineering and stone materials will be used to stabilize the new streambanks while the plantings are becoming established. The outside stream curves in wetland areas within the intermittent and perennial reaches can be stabilized with coir biologs up to the bankfull elevation, anchored into the wetland soil. The outside stream curves in upland areas can be stabilized with boulders and cobbles up to the bankfull elevation. Approximate linear feet of the materials associated with bank stabilization are included in Table 4. It was estimated that ¼ of the stream banks would require stabilization material, and 60% of the stream will have adjacent wetlands, while 40% are adjacent to uplands.

Riffles and pools should be established within the areas shown in the stream restoration grading plan in Attachment E. In the perennial section of the project, riffles make up approximately 56% of the reach, run is 20% and pools are 24%. Cobbles placed within the channel above stream curves can be used for creating riffle sections. If additional grade controls are needed within the stream channel, boulder/cobble weirs and/or logs embedded into the stream channel and banks can be used to create step pools. Materials salvaged from the construction area may be used for this purpose if they meet the material specifications on the grading plan.

The existing stream runs primarily through forested uplands and wetlands, and woody debris, mostly small woody debris, is present throughout. Large woody debris (LWD) provides habitat value and heterogeneity to a stream channel, and may be added as logs or root wads embedded into the streambank or dropped into or over the streambed to provide cover and shade while vegetation develops.

6.2 Stream Construction Methodology

Installation

Stream restoration construction notes are included in the stream restoration grading plan (Attachment D).

Dewatering methods

The contractor will be required to develop a dewatering plan for approval by NHDES prior to construction. The dewatering plan should address the following elements, at a minimum:

- Clean water bypass / stream diversion

- Method for dewatering proposed stream channel corridor
- Schedule and procedure for introducing stream flow to restored channel

Erosion and Sediment Controls

Temporary erosion and sedimentation controls including jute matting, erosion control socks, silt fence etc. will be installed as appropriate and maintained until vegetation is sufficiently established to hold soils in place. All materials must be “wildlife friendly”, made of natural materials (no plastic) and without knots. Erosion and sediment controls are shown on the Restoration Grading Plan (Attachment E).

Temporary erosion and sedimentation controls will be installed, monitored and repaired in conformance with the approved Erosion Control Plans, permit conditions and NHDOT Standard Specifications for Road and Bridge Construction, 2016.

Restoration schedule

Stream relocation work will be scheduled during a low flow season, either mid- to late summer or early winter. Revegetation will follow in the next available planting season after earthwork is complete, either spring or fall. Planting and seeding must take place when the ground is not frozen. If revegetation takes place in the spring, the first monitoring visit will be conducted late during the growing season of the same year. If revegetation occurs in the fall, monitoring will begin in the following growing season. A construction sequence with approximate dates is shown in Table 5 below:

Table 5 – Construction Sequencing/Sample Schedule

CONSTRUCTION SEQUENCE DESCRIPTION	APPROXIMATE SCHEDULE
Begin stream restoration construction (pending low flow)	Early August 2021
Install erosion and sedimentation controls (including stream diversion)	2 weeks
Flag desirable shrubs and saplings for salvage	0.5 weeks
Stockpile salvaged plant/soil materials	1 week
Excavate new channel	1 week
Grade and install new/salvaged stream channel materials	2 weeks
Replace/augment buffer and bank soils	1 week
Final grade work area/buffer	0.5 weeks
Apply erosion control jute and temporary seed (includes vegetation growth)	4 weeks
Introduce streamflow gradually into new channel	0.5 weeks
Install streambank and buffer plantings (immediately for salvaged/container plants; November to March for live stakes).	4 weeks
Final seeding	Next growing season
Initiate post-construction monitoring (see Monitoring Plan).	Next growing season
Remove temporary erosion and sedimentation controls when soils are stable. (date pending approval of soil stability)	When vegetated

ATTACHMENT A

FINAL CORRESPONDENCE WITH NHHB AND NHFG



NEW HAMPSHIRE NATURAL HERITAGE BUREAU

DIVISION OF FORESTS & LANDS - DNCR

172 PEMBROKE ROAD, CONCORD, NH 03301

(603) 271-2214 <https://www.nh.gov/nhdfl/>

April 2, 2020

Marc Laurin
NH Department of Transportation
PO Box 483
7 Hazen Drive
Concord, NH 03302-0483

RE: Exit 4A, Derry-Londonderry, 13065

This memo is to summarize coordination between the NH Natural Heritage Bureau (NHB) and the NH Department of Transportation (NHDOT) relative to potential rare plant species impacts from the construction of a new exit (4A) on Interstate 93 in Derry and Londonderry.

NHB provided various DataCheck letters throughout the development of the project, and shared digital database records through a Data Sharing Agreement. This data was used to inform rare plant survey planning and protocols.

Rare plant surveys were completed for this project in 2016, and no rare plant species were documented. However, the 2016 DataCheck for this project, NHB16-0960 (dated 4/4/2016), did not include Nuttall's reed grass (*Calamagrostis cinnoides*; synonym *Calamagrostis coarctata*), since the nearby record for this species was not added to the NHB database until 6/21/2016. During 2018 coordination on this project, NHB recommended that pre-construction surveys occur in any areas of appropriate habitat that would be impacted by the project.

This obligate wetland species generally occurs in open wetlands including peatlands, wet meadows, semi-disturbed areas (e.g., along railroad tracks), wetland edges, and utility rights-of-way. The nearby record for the species is within a utility right-of-way. The following NHB database excerpt describes the habitat of the nearby Nuttall's reed grass (*Calamagrostis cinnoides*) occurrence:

“Wet areas in powerline right-of-way. Associated plant species include gray birch (*Betula populifolia*), wrinkle-leaved goldenrod (*Solidago rugosa*), red maple (*Acer rubrum*), meadowsweet (*Spiraea alba* var. *latifolia*), and sweet-fern (*Comptonia peregrina*).”

While this is not the only possible habitat or suite of associated species, this information can inform target survey locations within the project area. The areas most likely to support Nuttall's reed grass (*Calamagrostis cinnoides*) are in Londonderry, just east of I-93, where a section of new proposed roadway would cross through three segments of utility right-of-way. NHB recommends that surveys occur in all wet meadows, edges of wetlands, and PEM/PSS wetlands within the utility right-of-way, as well as any additional habitats that are identified.



NEW HAMPSHIRE NATURAL HERITAGE BUREAU

DIVISION OF FORESTS & LANDS - DNCR

172 PEMBROKE ROAD, CONCORD, NH 03301

(603) 271-2214 <https://www.nh.gov/nhdfl/>

This species Nuttall's reed grass (*Calamagrostis cinnoides*) is in fruit from August to October; mature fruit is necessary to identify the species. NHB recommends that a botanist experienced in grass identification complete the survey for this species. Note: links to information about species identification and ecological characteristics are included on page three, below.

If the species Nuttall's reed grass (*Calamagrostis cinnoides*), or any other listed species, is identified within the project area, please complete a rare species reporting form and document the population using GPS, then contact NHB.

- If plants are found within the project area but outside of impact areas, contact NHB to discuss whether installation of protective orange fencing during construction may be warranted.
- If plants are found within the project area, with a small proportion (less than 10%) within impact areas, contact NHB to discuss. NHB may request seed collection instead of attempting to transplant whole plants, in the event that a small proportion of the overall reproductive population would be impacted. Depending on the extent and nature of the impacts, NHB may request follow-up monitoring to determine if the project would have additional indirect (e.g. hydrological) impacts on the population.
- If plants are found within the project area, with a larger proportion (greater than 10%) within impact areas, contact NHB to discuss. NHB may request transplanting impacted plants in the event that a larger proportion of the overall reproductive population would be impacted. Depending on the extent and nature of the impacts, NHB may request follow-up monitoring of the remaining (non-transplanted) plants, to determine if the project would have additional indirect (e.g. hydrological) impacts on the population.

The Project also involves the relocation of Trolley Car Lane stream, which is located along the west side of I-93, north of the Ash Street/Pillsbury Road bridge over I-93. This restoration project may provide an opportunity and habitat for transplanting impacted Nuttall's reed grass plants. Please contact NHB to discuss further if there will be impacts to >10% of a documented rare plant population, as described above.

Thank you, and please contact me with any questions.

Amy Lamb
Ecological Information Specialist, NH Natural Heritage Bureau
Amy.Lamb@dnrc.nh.gov, 603-892-5162



NEW HAMPSHIRE NATURAL HERITAGE BUREAU

DIVISION OF FORESTS & LANDS - DNCR
172 PEMBROKE ROAD, CONCORD, NH 03301
(603) 271-2214 <https://www.nh.gov/nhdfl/>

Nuttall's reed grass (*Calamagrostis cinnoides*) identification and ecology resources:

<https://www.maine.gov/dacf/mnap/features/calcin.htm>

http://beta.semanticfna.org/Calamagrostis_cinnoides

<https://gobotany.nativeplanttrust.org/species/calamagrostis/cinnoides/>

https://explorer.natureserve.org/Taxon/ELEMENT_GLOBAL.2.149330/Calamagrostis_coarctata

From: [Doperalski, Melissa](#)
To: [Laurin, Marc](#)
Cc: [Benedict, Karl](#); [Mauck, Ridgely](#)
Subject: NHB19-3453 (NHB18-2355) Derry-Londonderry, 13065 - Exit 4A
Date: Friday, April 10, 2020 2:56:47 PM
Attachments: [racer flyer Winchester.pdf](#)
[Derry-Londonderry 13065 - Exit 4A.msg](#)
[Spotted Blandings Flyer Feb2020.pdf](#)

Marc,

NHFG has reviewed the information provided for the proposed project that includes a new interchange one mile north of Exit 4 on Interstate 93 in Londonderry and Derry. The project would consist of an easterly only new construction access that would connect with Folsom Road and traverse along Folsom and Tsienneto Roads. It appears that Preferred Alternative A is the alternative moving forward although I do not have confirmation. In either scenario, all alternatives would be within the same vicinity that the NHB datacheck was completed. The NHB Datacheck Results Letter (NHB19-3453 – former NHB18-2355) resulted in the following species records within the project area: Blanding’s turtle (state endangered), spotted turtle (state threatened), Northern black racer (state threatened), New England cottontail (state endangered), smooth green snake (species of special concern) and Jefferson/Blue-spotted salamander complex (tracked) species.

The FEIS for the project included specific state T&E mitigation “impact minimization and mitigation” for all species listed on the NHB datacheck results letter (section 4.17.3 Mitigation). This includes (note there are additional details within section 4.17.3 that apply – below is a summary) * denotes additional information that NHFG wishes to be included but was not detailed in the FEIS:

- The project area will be searched prior to project construction for Northern black racers as well as other reptiles as noted above prior to construction and before heavy machinery is brought onsite.
- Surveys would be conducted by a qualified biologist during appropriate weather conditions and all areas that may be impacted would be thoroughly searched.
- Note that multiple surveys may be needed depending on sequence and timing of ground-disturbing activities.
- All species encountered during the survey will be moved to an area outside of the active construction zone but nearby and in the direction they are moving in (if applicable).
- NHFG would be contacted immediately if any of the species encountered are threatened or endangered species.
 - *The following language should be included on site plans:
 - **Contact NHFG immediately if state threatened or endangered species are encountered during site surveys or during project construction. Melissa Doperalski 603-479-1129 or NHFG Wildlife Administration at 603-271-2461. Photographs of animals should be taken if feasible to help in identification.**
- *Contact NHFG immediately if a potential Northern black racer hibernacula is found (this applies to spring surveys (April – May). If project construction may occur prior to June, please contact NHFG for additional information on potential hibernacula.
- Wildlife exclusionary fencing will be installed prior to September 15th to exclude snakes from returning to potential hibernacula. Wildlife exclusion fencing will be installed to include

the work area as well as any material storage areas.

- Wildlife exclusionary fencing will be maintained and kept on site through the duration of the project and removed once the project has been completed.
- *Northern black racers are good climbers and can likely climb exclusionary fence measures. Site personal shall be provided information that helps to identify Northern black racers and other species as listed above in addition to NHFG contact and communication during the life of the project. (flyer and factsheet information provided by NHFG that are currently available for use). New England cottontail information and reporting can be found on the NHFG website at <https://www.wildlife.state.nh.us/wildlife/profiles/ne-cottontail.html>. Smooth green snake information can be found at <https://wildlife.state.nh.us/wildlife/profiles/smooth-green-snake.html>.
- *Wildlife exclusionary fence installation: If using a traditional silt fence NOTE that the wood posts should be placed such that they are located on the INSIDE of the project site. This is opposite to how they are installed if they are used for water quality measures. In addition, the fencing should be buried 8-12 inches below grade as several animals can burrow underneath fencing. (note not for permitting – there is a company that offers fencing that is specifically designed for wildlife exclusion – [Animex](#).)
- All erosion control materials will be wildlife-friendly. *We request that the type of material be specified on site plans.*

It is understood that Compensatory mitigation will be primarily an ARM fund payment, but may include other local infrastructure improvement projects through SPIP program.

Just for future reference, we would prefer the locational discussion (Table 4.17-2; column “Observations within the last 25 years”) not be included. This information isn’t necessary for this type of review and can often be confusing for the reader or misinterpreted. Locational data is considered confidential and should not be included in any public documents and is protected from right-to-know requests. Only the top letter portion of the NHB letter can be included in a public document.

Thank you for your patience in our review. Please let me know if there are additional questions you may have or are in need of addition information or clarification for the comments above.

Melissa

Melissa Doperalski

Certified Wildlife Biologist®

Nongame and Endangered Wildlife Program

New Hampshire Fish and Game Department

11 Hazen Drive

Concord, New Hampshire 03301

Melissa.doperalski@wildlife.nh.gov

Phone: 603-271-1738

<http://www.wildlife.state.nh.us/nongame/index.html>



Check out reptiles and amphibians of NH!

<http://www.wildlife.state.nh.us/nongame/reptiles-amphibians.html>

Report your sightings of reptiles and amphibians in 3 ways:

- 1) Email details of observation or completed form to RAARP@wildlife.nh.gov
- 2) Enter your observation online at <http://nhwildlifesightings.unh.edu>.
- 3) Mail your reporting slip <http://www.wildlife.state.nh.us/nongame/documents/raarp-report-form.pdf>

From: Laurin, Marc <Marc.Laurin@dot.nh.gov>
Sent: Thursday, March 26, 2020 7:50 AM
To: Doperalski, Melissa <Melissa.Doperalski@wildlife.nh.gov>
Subject: Re: Derry-Londonderry, 13065 - Exit 4A

Melissa,

The FEIS Section 4.17 can be accessed on the Exit 4A web site at

http://www.i93exit4a.com/assets/FEIS_ROD/Volume_I/Section_4.17_-_Threatened_and_Endangered_Species.pdf

Let me know if you need anything else.

Marc

From: Doperalski, Melissa
Sent: Wednesday, March 25, 2020 3:48:38 PM
To: Laurin, Marc
Subject: RE: Derry-Londonderry, 13065 - Exit 4A

Can you also send me the pages in the FIS that discuss the other species identified through the NHB datacheck process and how they were considered for this project please?

I have communications in my file from Sarah that specifically address concerns to black racers but I don't have that we communicated regarding the other T&E species that were identified by the NHB datacheck results letter.

Melissa

From: Doperalski, Melissa
Sent: Wednesday, March 25, 2020 3:17 PM
To: Laurin, Marc <Marc.Laurin@dot.nh.gov>
Subject: RE: Derry-Londonderry, 13065 - Exit 4A

Thank you

From: Laurin, Marc <Marc.Laurin@dot.nh.gov>
Sent: Wednesday, March 25, 2020 3:10 PM
To: Doperalski, Melissa <Melissa.Doperalski@wildlife.nh.gov>
Subject: RE: Derry-Londonderry, 13065 - Exit 4A

Melissa,

The latest report we received is NHB19-3453, a previous report was NHB18-2355.

Thanks,

Marc

From: Doperalski, Melissa <Melissa.Doperalski@wildlife.nh.gov>
Sent: Wednesday, March 25, 2020 1:01 PM
To: Laurin, Marc <Marc.Laurin@dot.nh.gov>
Subject: RE: Derry-Londonderry, 13065 - Exit 4A

Morning Marc,

Thank you for your patience, I have transitioned to working from home so still getting adjusted. Can you provide me with the NHB number please for this review. We file our project comments based on that number.

Thanks,
Melissa

From: Laurin, Marc <Marc.Laurin@dot.nh.gov>
Sent: Tuesday, March 24, 2020 9:49 AM
To: Doperalski, Melissa <Melissa.Doperalski@wildlife.nh.gov>
Subject: RE: Derry-Londonderry, 13065 - Exit 4A

Melissa,

Have you been able to evaluate the Exit 4A information as we discussed last week? Karl Benedict at DES is asking to have a complete list of NHFG final comments/recommendation to evaluate and include as a condition to their Wetland Permit as soon as possible. I understand that this is not

business as usual and we are all coping as best we can with the situations we are in now. Let me know if there is anything I can provide that would help you with your review.

If you could give me a time frame that I could relate to Karl that would be helpful.

Thanks,

Marc

From: Laurin, Marc
Sent: Monday, March 02, 2020 12:25 PM
To: Doperalski, Melissa Melissa.Doperalski@wildlife.nh.gov
Subject: Derry-Londonderry, 13065 - Exit 4A

Melissa,

Kim Tuttle informed me that you were the person reviewing the Exit 4A project for state fish and wildlife concerns.

On January 15th Lee Carbonneau, of Normandeau Associates, sent Kim the attached email regarding DES's Wetlands Bureau questions about if DOT has properly addresses any F&G concerns on the project.

Could you please review and let me know of any concerns or questions you have on the project. We want to make sure we have all the appropriate information from F&G that would need to be factored in by the Wetland's Bureau for their issuance of a Dredge and Fill permit.

Thanks,

Marc Laurin
Senior Environmental Manager
Bureau of Environment
NH Department of Transportation
(603) 271-4044

Northern Black Racer

(New Hampshire state threatened species)



- Solid black with a white throat and chin
- Slender with glossy scales, 3-6 ft. long
- Hatchlings are very small and patterned



**Immediately report sightings to NH Fish and Game
Melissa Doperalski (603-419-1129) or
Brendan Clifford (603-944-0885)**

***Please report promptly, noting specific location and date
Photographs strongly encouraged***





PLEASE REPORT OBSERVATIONS OF RARE TURTLES

*The NH Fish & Game Department is requesting
observations of four turtle species*



Blanding's turtle

(State Endangered)

Large, dark/black domed shell
with lighter speckles.

Distinct yellow throat/chin.

Aquatic but often moves on land.



Spotted turtle

(State Threatened)

Small, mostly aquatic with
black or dark brown with
yellow spots.

Fairly flat shell compared
to Blanding's turtle.

Spots vary in color and
number.

Report sightings immediately to NHFG Wildlife Division at 603-271-2461 (M-F 8-4) or to
NHFG Wildlife Biologist Melissa Doperalski 603-479-1129 (cell) anytime.

Please report promptly, noting specific location and date – Photographs strongly encouraged

ATTACHMENT B

PHOTOGRAPHS/PHOTO STATIONS APRIL 2020

Trolley Car Lane Stream (S1) - 2020 Photo Stations

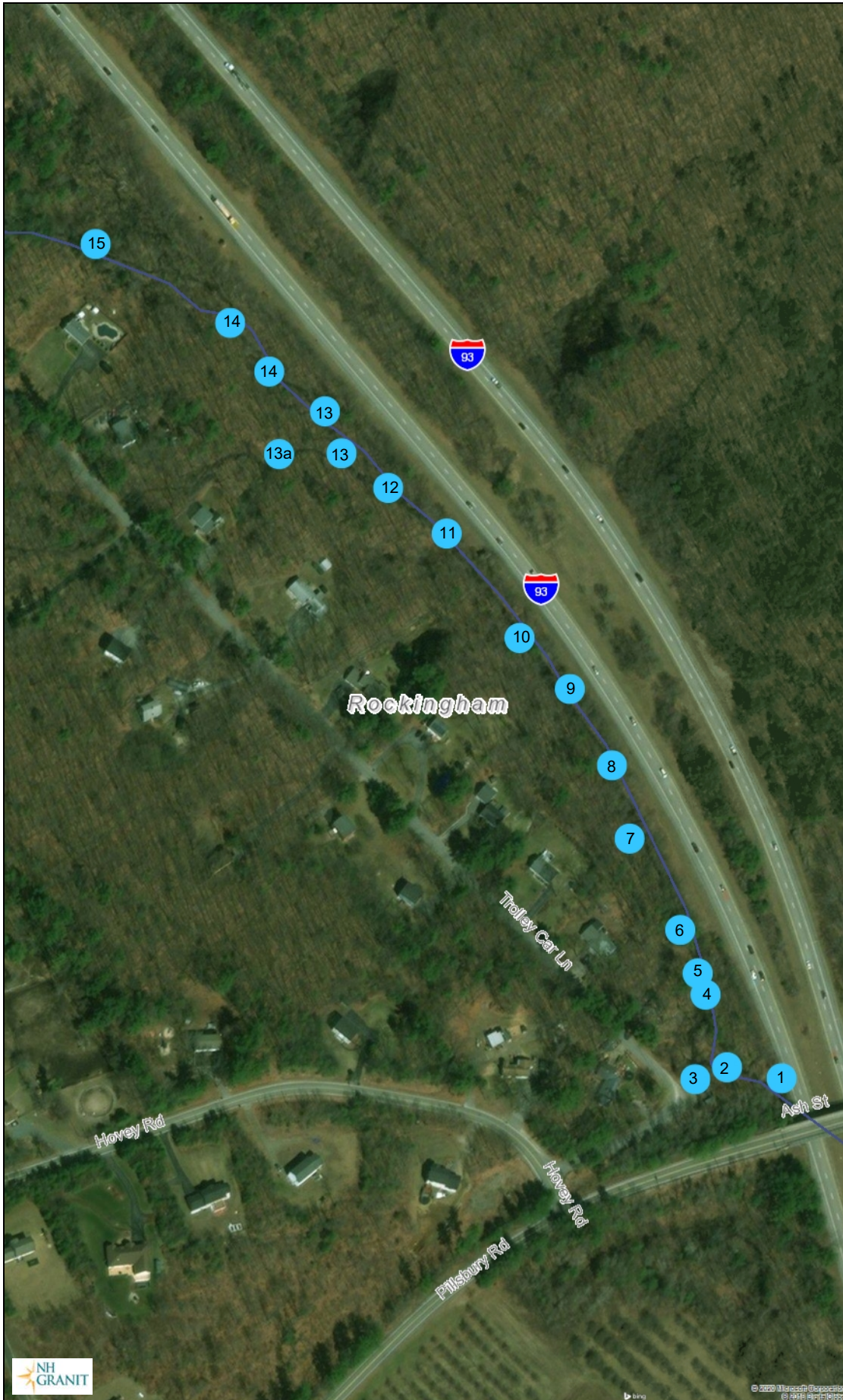

Legend

- State
- County
- City/Town
- Stream Centerlines
 - Perennial Stream
 - Intermittent Stream
- Artificial Paths
- Other Water Features
 - River
 - Spillway
 - Inundation Area
 - Dam/Weir
 - Canal/Ditch
 - ⊗ Rapids
- Photo Station Location

Map Scale

1: 3,247

© NH GRANIT, www.granit.unh.edu

Map Generated: 4/27/2020



Notes



Stream S1 (Trolley Car Lane stream) Photos – April 1, 2020
South to North



Station 1 – Stream outlet culvert. The invasive *Reynoutria japonica* dominates streambank. The east bank is cleared for construction. The outlet pipe is scheduled to be extended in May 2020 by the I-93 project. Water is 2-3" deep, and drops several inches over a log just upstream of the culvert. Gravel substrate at this location.

Stream S1 (Trolley Car Lane stream) Photos – April 1, 2020
South to North



Station 2. View downstream at edge of forest just above disturbed area. *Reynoutria japonica* is present along the streambank. Substrate is gravel and cobble.



Station 2. View upstream *Alnus incana* and *Cornus amomun* are dominant along stream channel. Gravel and cobble substrate. Thalweg in this run segment is approximately 16" deep.

Stream S1 (Trolley Car Lane stream) Photos – April 1, 2020
South to North



Station 3. Small stream tributary that enters S1 from the west through a culvert under Trolley Car Lane. Approximately 2' wide and 2-3" deep.

Stream S1 (Trolley Car Lane stream) Photos – April 1, 2020
South to North



Station 4. S1 crosses the ROW fence at this location. View is downstream. Stream is a run here, with *Lindera benzoin* in the adjacent wetland, and *Carpinus caroliniana* along the stream.



Station 4. Fence across the stream, view upstream. Stream is approximately 12" deep, sand and organic substrate.

Stream S1 (Trolley Car Lane stream) Photos – April 1, 2020
South to North



Station 5. View across S1 from the ledge outcrop on the western bank, to a recently constructed surface drainage outlet from I-93. Streamside shrubs include *Corylus americana* and the invasive *Berberis thunbergii*.

Stream S1 (Trolley Car Lane stream) Photos – April 1, 2020
South to North



Station 6. Channelized, gravel substrate run and riffle segment within steep rocky banks. No floodplain in this location. Small *Pinus strobus*, *Fraxinus pennsylvanica* and *Acer rubrum* present along the streambanks.

Stream S1 (Trolley Car Lane stream) Photos – April 1, 2020
South to North



Station 7. S1 where it flows through Wetland 16 in a channel approximately 20' wide and 12" deep. This section is a slow run or pool. *Acer rubrum* and *Betula allegheniensis* trees and wetland shrubs, including *Lindera benzoin*, *Ilex verticillata*, and invasive *Berberis thunbergii* dominate. Sand and organic substrate.

Stream S1 (Trolley Car Lane stream) Photos – April 1, 2020
South to North



Station 8. Above: Flow enters from culvert under I-93, draining Wetland 15 and associated stream located on east side of I-93.

Below: View upstream of culvert. Run and riffle segment bordered by *Acer rubrum* trees in a narrow floodplain.



Stream S1 (Trolley Car Lane stream) Photos – April 1, 2020
South to North



Station 9. Channelized stream in a slightly wider floodplain wetland. Channel is approximately 10' wide, and 9" deep, with sand and organic substrate. Stream edge is dominated by *Lindera benzoin*, *Acer rubrum*, *Onoclea sensibilis*, *Osmunda cinnamomea*, *O. claytoniana*, and *Symplocarpus foetidus*. Also what appears to be *Forsythia* sp.



Stream S1 (Trolley Car Lane stream) Photos – April 1, 2020
South to North



Station 10. An small, intermittent stream enters from the west from a small pond. The *Fraxinus* and *Acer* trees have shallow exposed roots. S1 is approximately 10' wide at this location, but a pool approximately 20' X 20' is also present at this confluence.



Stream S1 (Trolley Car Lane stream) Photos – April 1, 2020
South to North



Station 11. A culvert under I-93 introduces flow from Wetland 16 and VP3 located on the east side of I-93 at this location. S1 is more sinuous here, with slight but numerous bends. Thalweg is approximately 12" deep, with gravel substrate. Run and occasional riffles with branches and other organic debris. A seepy wetland borders to the west. Dominant streambank plants include *Carpinus caroliniana*, *Acer rubrum*, *Cornus amomum*, and *Sambucus canadensis*.

Stream S1 (Trolley Car Lane stream) Photos – April 1, 2020
South to North



Station 12. ROW fence crosses in this location. This is also the approximate border between the intermittent and perennial reaches. Riffles with cobble, boulder and gravel substrate. Channel is approximately 8' wide and water is 8-12" deep. Small trees but relatively few shrubs grow along the bank.

Stream S1 (Trolley Car Lane stream) Photos – April 1, 2020
South to North



Station 13 (above) and 13a (left). Intermittent reach, looking upstream at the braided sections of the main stream. Substrate is boulder and cobble; islands are forested with small *Acer*, *Fraxinus* and *Carpinus* trees. . Downstream of Station 13, the stream is in one channel. A side tributary (left, Station 13a), drains land west of Trolley Car Lane and joins S1.

Stream S1 (Trolley Car Lane stream) Photos – April 1, 2020
South to North



Station 14. The main channel splits in this location, with a tributary off to the east. Each channel is approximately 3-4' wide and sinuous, with runs and riffles. Wide floodplain, primarily wetland. *Fraxinus*, *Acer*, *Carpinus*, *Ostrya virginiana*, *Quercus rubra*, *Symplocarpus foetidus*, and ferns dominate.



Stream S1 (Trolley Car Lane stream) Photos – April 1, 2020
South to North



Station 15. The main branch of S1 enters the project site from the northwest at this location. The channel is 5-8' wide, well-defined, with sand and gravel substrate, running through a forested wetland. Dominant streamside and wetland vegetation includes *Lyonia ligustrina*, *Symplocarpus foetidus*, *Acer rubrum*, *Betula allegheniensis*, sedges and ferns.



ATTACHMENT C

STREAM RESTORATION/RE-ESTABLISHMENT MONITORING PLAN

**NHDES Mitigation Program
Stream Restoration/Re-establishment Monitoring Plan**

Project Name: Trolley Car Lane Stream Restoration/Re-establishment		
Project Information	<i>Main Project Contact</i> Andrew O’Sullivan	<i>Main Project Contact-</i> NH Department of Transportation
	<i>Address</i> NHDOT, PO Box 483, 7 Hazen Drive, Concord, NH 03302-0483	
	<i>Site Location – West of I-93 and east of Trolley Car Lane between Pillsbury Road and 28 Trolley Car Lane, Londonderry, NH</i>	<i>Project Dates:</i> Construction summer 2021 Monitoring spring 2022- summer 2026
	<i>Permit numbers and approval dates</i> 2018-03134	
Monitoring Information	<i>Monitoring Contact- Andrew O’Sullivan Wetlands Project Manager, NHDOT</i>	<i>Monitoring Contact -</i>
	<i>Monitoring Contact</i> NHDOT, PO Box 483, 7 Hazen Drive, Concord, NH 03302-0483 (603) 271-0556 Andrew.O’Sullivan@dot.nh.gov	
	<i>Reporting Period Dates- filled in for each monitoring report</i> December 31, 2022 December 31, 2024 December 31, 2026	

1. Monitoring Plan Structure

- The pre- and post-construction monitoring parameters, methods to assess each parameter, and the targets for each metric (i.e. performance measures) are identified in Tables 1 and 2. These should be reviewed and agreed upon by the NHDES, USACE, project partners, and a NHDES Wetlands specialist.
- A pre-construction survey was completed in 2010 to document baseline conditions at the site for comparison with subsequent data to assess channel and floodplain response to the restoration and culvert upgrade activities. A photo-survey was also conducted in early spring 2020 to record observed channel conditions.
- Post-construction monitoring will be conducted during a moderate flow (spring/fall) and low flow (late summer) period each year for the first, third and fifth years, and within 24 hours following one ≥ 50 -year storm event — if one occurs within the 5-year time frame.
- Monitoring reports shall be submitted by December 31 of the monitoring year to Cheryl Bondi at Cheryl.bondi@des.nh.gov, Lori Sommer at Lori.Sommer@des.nh.gov, and other pertinent NHDES personnel and partners involved with this project.
- By the 3rd year post-construction actions must be taken to remove all remaining sediment controls, silt fences, and nylon netting from the banks and riparian area.

Photographic evidence indicating that there are no remaining erosion controls structures in the project area must be provided in the year 3 monitoring report.

2. Project Summary

The NHDOT will relocate approximately 1,700 linear feet of the Trolley Car Lane stream (Stream S1, Wheeler Brook) within the existing I-93 ROW to accommodate sound walls for the I-93 expansion and the new Exit 4A interchange ramp. Portions of stream S1 will be permanently shifted west by up to 50 feet to accommodate the fill slopes along the highway, and the stream will be reconstructed as an open, functional stream channel with adjacent vegetated buffer. Additional flood storage will be provided just upstream of the project area to compensate for the flood storage that will be lost as a result of fill in Wetland 14, through which stream S1 flows. Culverts which carry flow from tributary streams and wetlands on the east side of I-93 to Stream S1 will be extended under the fill to meet the relocated stream channel.

3. Project Goals

Stream S1 will be reconstructed to maintain the hydraulic capacity of stream flow and re-create as many of the morphological characteristics of the existing intermittent and perennial stream reaches as possible. The goals of the restored stream are to:

- Avoid any increase in the incidence of flooding within or below the affected stream reach;
- Maintain similar velocities and flow as currently exist within the stream reaches, and accommodate the existing side tributaries from the east and west;
- Re-establish channel sinuosity, bankfull width and depth ratios, and entrenchment ratios to the extent practicable within the constraints of the available ROW;
- Establish channel materials and profile grade controls to allow natural stream channel dynamics within the relocated reach; and
- Establish a buffer of native vegetation along constructed portions of stream channel.

Table 1. Summary of restoration goals and monitoring parameters to evaluate success of the Trolley Car Lane Stream Restoration project in Londonderry NH.

Restoration Goal	Purpose	Monitoring Parameters
Flood Hazard Mitigation	Documenting flooding events at the outlet of the 60 inch culvert to assess if flood risks have not increased.	<ul style="list-style-type: none"> • Reports from highway department and local knowledge on culvert overtopping • Photos during large flood events • Inspection following large storms
Channel can adequately pass streamflows and sediment	Measuring the stream channel shape and substrate types within the relocated reach to show whether the relocated stream's flood prone area design properly accommodates stream flow and sediment.	<ul style="list-style-type: none"> • Floodplain and bankfull widths • Wetted widths • Bankfull height • Water depths (include deepest section) • Channel slope • Substrate types
Stormwater Treatment and Road Runoff Control	Regular inspection of the erosion control measures and stream banks will demonstrate if the structures are functioning as designed, trapping sediment efficiently, and alleviating bank erosion issues.	<ul style="list-style-type: none"> • Visual assessment of the stability/function of stormwater control structures • Bank erosion assessment
Restore floodplain plants	Assessments of the plantings within the relocated stream's planted buffer will show the percent of buffer plantings that have survived and whether there has been invasive species establishment.	<ul style="list-style-type: none"> • Community structure- % plant cover • Invasive species presence/cover • Planting survival • Plant condition
Cross-sections	Cross-sections will show channel adjustments (i.e., degradation, aggradation, widening, narrowing) in response to the stream relocation.	<ul style="list-style-type: none"> • Install cross sections across the main channel at 12 locations including at grade control structures and at the tributary confluences. See attached map for approximate locations.
Longitudinal Profile	Longitudinal surveys will show how the channel slope is adjusting to the grade controls installed in the stream. Any aggradation, scour, and identified steep section of channel that affect site passage for aquatic organisms will be noted.	<ul style="list-style-type: none"> • One longitudinal profile will be surveyed on the mainstem. Data will be collected using a total station. Please see map for approximate locations.

4. Survey Methods

Define the Monitoring Reach

The length of stream and riparian area that will be monitored are outlined on the site map (Map 1). The monitoring reach will include approximately 1,800 feet, and extend at least 5-10 bankfull widths upstream of the relocated stream as access permits, and downstream to the existing 60-inch culvert under I-93.

Flood Hazard Mitigation

Document how the new stream channel passes flows and sediment during large storm events. Collect any reports from road agents, highway department, and local residents following large precipitation or snow melt events on overtopping, erosion, and channel flooding. Submit this evidence as a narrative and provide a description of any damage that may have occurred and include photos if they are available.

Channel can Adequately Pass Streamflows and Sediment

A set of 12 cross-sections will be established using wooden posts or flagging, upstream and within the relocated channel (Map 1). The number of upstream cross-sections will be limited and will only be established in the area directly upstream of the relocated stream. The downstream cross sections will be placed 1) directly below the beginning of the re-established channel, 2) across and in between any grade controls (rock weirs or vanes), and 3) downstream of the tributary confluences with the existing channel (Map 1). At each cross-section measure:

- 1) Bankfull width
- 2) Wetted width
- 3) Bankfull height at 5 evenly spaced intervals across the cross-section
- 4) Water depth at 5 evenly spaced intervals across the cross-section- be sure that one measurement captures the **deepest** section of the cross section
- 5) The dominant and subdominant substrate types (Diagram 2)
- 6) Take one photo across the river from right bank to left bank

*Refer to the *New Hampshire Stream Crossing Initiative: Field Manual* for instructions on how to determine bankfull height and width, measure across the channel, and determine substrate types.

Stormwater Treatment and Road Runoff Control

Walk the entire length of the monitoring reach and visually assess the banks for signs of erosion. Indicators of erosion include undercutting of the stream bank, bank slumping, exposed roots, and falling trees. At locations where bank erosion is observed take a photo and indicate its location on the site map. Document the severity and provide a description of the bank. Once an area of bank erosion has been identified, continue to monitor and document changes over time in subsequent reports.

In areas where bank stabilization work was done, assess whether they are structurally intact and performing as designed, and include observations of damage, wear to the structures, or soil instability (i.e. presence of rills, gullies, fissures). Visually assess the erosion control measures

that have been installed. Document whether the erosion control measures and other structures are functioning as designed and whether they have been damaged. Take photos of all structures.

Restore Floodplain Benches and Plants

Monitor the area where the New England seed mix was applied and native woody vegetation (elderberry, pussy willow and silky dogwood stakes, and container-grown and/or salvaged spicebush, dogwood, elderberry, alder, ironwood, yellow birch and red maple) were planted within the flood prone restoration area on left and right banks) depicted in Map 1. Visually estimate the plant cover including diversity and percent cover within 1-meter plots that are placed in the riparian area adjacent to each cross section (Map 1). Assess the survival and condition of plantings, as well as any new plants that have been recruited to the restoration area. Estimate the percent cover of any invasive species in the floodplain. Take photos of each of the vegetation plots.

Established Cross-sections

The monitored cross sections were selected based on the engineers designed grade controls in the existing plan set. These locations will be used together to provide information on the project restoration's goal of a stable channel elevation in the restored reach. The cross-sections will be georeferenced (post-construction), flagged, and mapped for monitoring consistency (Map 1). Several of the monitoring parameters, such as sediment distribution, photo stations, and longitudinal profile data, will be evaluated at each cross-section for long-term observations of change. Once established, these cross-section locations will not change. Preliminary visual assessments will be made prior to initiating construction and use of spatial imaging (such as LiDAR or aerial photos) will be used to aid in long term review of the channel changes. Channel and bank features will be collected as part of the monitoring protocol at established cross-sections. The following data will be observed and recorded: areas of aggradation, bed scour, bank erosion, and changes to installed structures (i.e. bioengineering materials, wood additions, rock weirs, grade control stones, and constructed step-pools). Cross-section measurements within the project reach will include floodplain width, bankfull width, wetted width, and water surface elevations/depths.

Longitudinal Profiles

One longitudinal profile (long-pro) will be created as part of this monitoring plan. The long-pro will extend the entire length of the monitoring area which is approximately 1,800, including the relocated channel and the immediately upstream reach. Beginning immediately below where stream flow was diverted for construction, the long-pro monitoring will primarily collect thalweg elevations but also include newly developed instream features such as riffles, boulder constrictions, and large pools. Additional measurements, concentrated at established cross-sections, will include areas of interest such as depositional features and downstream scour at grade control features to observe changes in channel geometry. Newly formed habitat features (i.e. pools, riffles, and runs) will be documented, as well as instream habitat structures such as log jams, downed trees, and newly entrained large boulders.

Photo Documentation

Photos should be taken from the **same locations** for each monitoring event and included on the site map. Take repeated photos at these locations: 1) all downstream gradient structures (rock weirs/vanes and step-pools, if designed), 2) across the stream channel from right bank to left bank at each cross section 3) views of the stream channel directly upstream 4) views of the stream channel directly downstream 4) erosion control structures and 9) areas of the floodplain where plantings were done. Photos may be included in an appendix, submitted as a separate file, or in the text to correspond with the data for each parameter.

Map 1. Diagram showing locations of the cross sections (red lines), vegetation plots (orange boxes) within the monitoring reach at Trolley Car Lane Stream, Londonderry, New Hampshire.

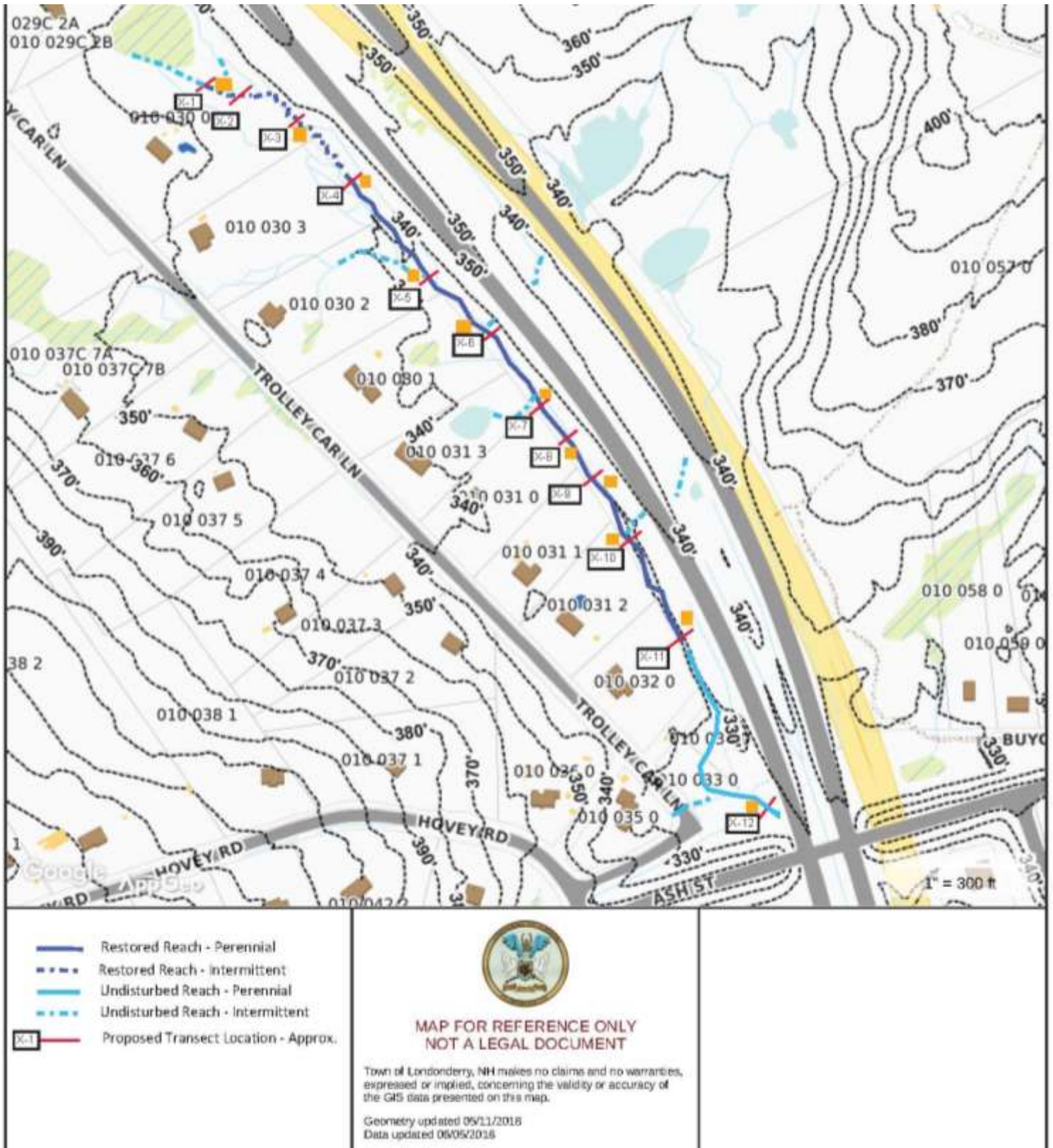

Table 2. Summary of Restoration Goals and Performance Measures for Trolley Crossing Lane Stream Restoration. Describe the current conditions on the site post-construction (at Year 1, 3, and 5) relative to the restoration goals. Summarize the data for each of the monitoring parameters to substantiate the success (or failure) relative to the specified performance standards listed in Table 3.

Restoration Goal and Description	Pre-Restoration- 2020 Baseline Condition (as measured in 2010)	Target Post-Restoration Condition	Year 1- 2022 Parameter Observations	Year 3-2024 Parameter Observations	Year 5- 2026 Parameter Observations	Explanation on target performance standards
Flood Hazard Mitigation	Stream flows can flood adjacent wetlands on occasion, but no flooding at 60 inch culvert.	No increase in downstream flooding at 60 inch culvert outfall.				
Channel can adequately pass streamflows and sediment	No evidence of scour and erosion visible along channel or at tributary confluences.	No evidence of scour along channel. No evidence of scour and erosion at the tributary confluences.				
Stormwater Treatment and Road Runoff Control	Runoff of road material and banks adjacent to the road enter the stream during rain events.	Improved treatment of stormwater runoff with BMP erosion controls.				
Restore floodplain plants	Forested wetlands and uplands with sparse shrub understory; dense fern/forb ground cover in wetlands; invasive shrubs present.	Plantings be successful and healthy and meet at least 75% cover native plantings in the planting areas.				

<p>Retain hydraulic continuity between the tributaries and main channel.</p>	<p>Three intermittent stream tributaries enter from the east and two from the west.</p>	<p>No evidence of scour along the channel.</p> <p>No evidence of scour and erosion at the tributary confluences.</p>				
<p>Longitudinal Profile</p>	<p>Drop of 16 feet through the reach, with several steps and pools.</p>	<p>Sediment and water are continuous through the relocated stream if designed Drop of 16 feet through the reach, with several steps and pools</p>				

5. Monitoring Results

Factors that may affect monitoring

Document any significant changes in the watershed that have occurred that may influence the response of the stream to the restoration activities such as, land use change, installation of water control structures, nearby development, and upstream road crossings. Provide stream flow estimates (USGS Stream Stats) if any large precipitation events have occurred that may affect the monitoring parameters.

Remedial Actions and Adaptive Management

Provide a summary of any remedial actions taken during the monitoring year and justifications as to why those actions were required. Include activities such as removing debris, replanting, controlling invasive plant species (with biological, herbicidal, or mechanical methods), regrading the site to achieve desired hydrology, and application of additional topsoil, soil amendments, or streambed materials, and provide the dates that remedial work was done.

Flood Hazard Mitigation

Have there been any reports of the area flooding during extreme precipitation events, or overall have hydraulic conditions been maintained? Have there been any large storm events in the monitoring time frame in which flooding beyond the floodplain occurred or the existing 60-inch culvert failed to pass streamflow?

Culvert Adequately Passes Streamflows and Sediment

Describe how channel shape and sediment distributions have changed compared with pre-restoration conditions. Have the bankfull widths upstream of the restoration site changed in response to the stream restoration work? Provide cross-sectional data showing how areas of aggradation and scour have evolved in response to changes in sediment transport and flows through the reach. Describe how sediment distributions in the monitoring reach have changed since restoration and whether restoration resulted in mobilization and redistribution of fine sediments.

Stormwater Treatment and Road Runoff Control

Report the status of the erosion control measures and bank stabilization structures on the restoration site. Are the stormwater treatment structures in place and functioning as intended? Summarize data collected on bank conditions and describe the overall level of bank stability across the site. Are there any areas of active erosion, aggradation, or bank failure of concern that may require remedial actions? If temporary measures are no longer needed, have they been removed?

Maintain full aquatic organism passage

Summarize the physical aspects of the channel that are facilitating aquatic organism passage such as the sediment continuity, water depths, and water velocity throughout the channel. Are there any obstructions to fish and aquatic organisms that would prevent movement upstream and downstream such as steep sections of channel? Are fish and other aquatic organisms that

may have been present still able to migrate to the extent that was possible prior to stream relocation? What aquatic organisms and wildlife have been observed using the site and what do they use it for (passage, nesting, feeding, shelter, etc.)?

Restore floodplain plants

Summarize the plant community in the floodplain benches in terms of plant diversity, percent cover, and persistence of plantings. Describe the survival rates for plantings and the overall health and condition of the surviving plants. Does the riparian vegetation appear to be providing soil stability and controlling runoff and erosion into the stream? Are there invasive species present in the restored portions of the monitoring reach and have actions been taken to remove those plants?

6. Conclusions

Summarize the overall status and conditions of the Trolley Crossing Lane stream restoration. Has the site progressed as expected? Has the site successfully achieved the project goals and approved performance standards or is it trending toward success as of the date of this report? If performance or success standards are not being met or other issues have been identified, include a brief discussion of the difficulties encountered and probable causes. What are the recommended remediation measures? Specific recommendations for any additional corrective or remedial actions including a time table must be provided.

Diagram 1 - Example of a cross-section and measurements collected across the stream.

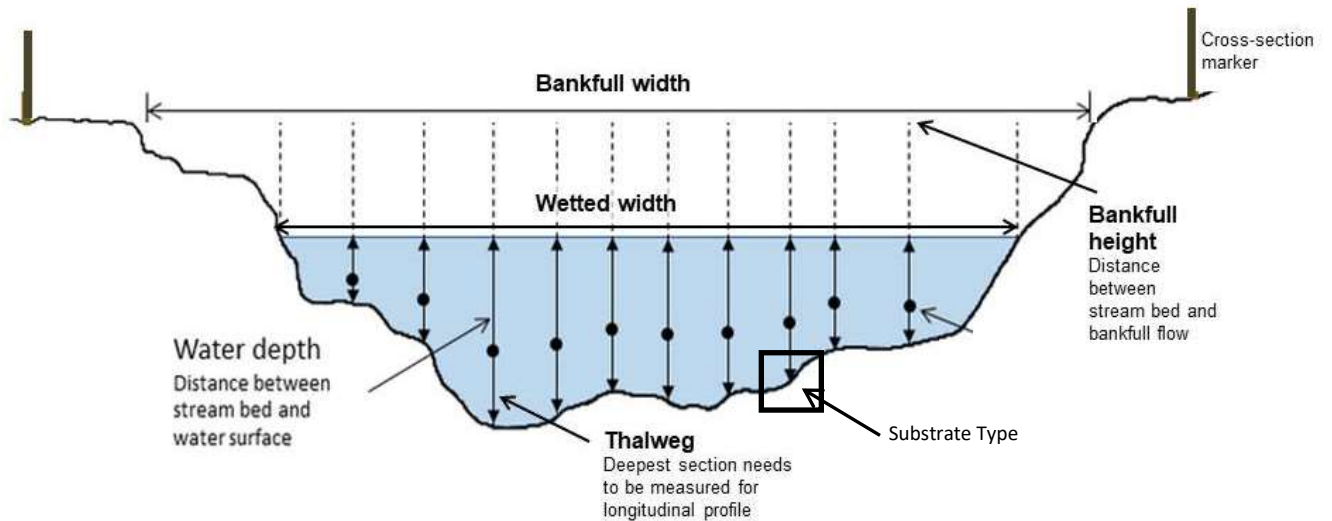

Diagram 2 - Grain sizes of different substrate types.

<u>Type</u>	<u>Grain size(in.)</u>	<u>Relative size</u>
BEDROCK	>160	bigger than a Volkswagen Bug
BOULDER	10.1-160	about the size of a basketball to a Volkswagen Bug
COBBLE	2.51-10	about the size of a tennis ball to basketball
GRAVEL	0.08-2.5	about size of peppercorn to a tennis ball
SAND	<0.08	the size of silt to the size of a peppercorn
SILT/CLAY	<0.002	grains are extremely fine and smaller than sand
UNKNOWN	Cannot assess due to turbid water or limited visibility.	

Appendices

Appendix A – Final Design and as-built Plans

If alterations were made to the approved restoration/enhancement plan due to conditions found in the field, as-built plans showing appropriate topography for type of restoration, structures including any inlet/outlet structures, grading, etc. must be submitted. These need only be submitted once and may be included in future monitoring reports by reference. If plantings were part of the project design, include the location and extent of the designed plant community types (e.g., shrub swamp).

Appendix B- Other supporting documents and photos

References

Chapman, A. 2013. New Hampshire Department of Environmental Services (NHDES) Protocols for Collection, Identification, and Enumeration of Freshwater Fishes.

<https://www.des.nh.gov/organization/divisions/water/wmb/biomonitoring/documents/20131118-fish-col-sop.pdf>

Chapman, A. 2013. New Hampshire Department of Environmental Services (NHDES) Protocols for Macroinvertebrate Collection, Identification and Enumeration.

<https://www.des.nh.gov/organization/divisions/water/wmb/biomonitoring/documents/20131118-macroinverts-col-sop.pdf>

Collins, M., K. Lucey, B. Lambert, J. Kachmar, J. Turek, E. Hutchins, T. Purinton, and D. Neils. 2007. Stream Barrier Removal Monitoring Guide. Gulf of Maine Council on the Marine Environment. www.gulfofmaine.org.

New Hampshire Volunteer River Assessment Program (VRAP) Water Quality Monitoring Sampling Protocols. *New Hampshire Department of Environmental Services*. 2018.

<https://www.des.nh.gov/organization/divisions/water/wmb/vrap/documents/vrap-protocols.pdf>

Statewide Asset Data Exchange System (SADES) New Hampshire Stream Crossing Initiative: Field Manual. *New Hampshire Department of Environmental Services*. 2018.

<https://www.des.nh.gov/organization/divisions/water/wetlands/documents/culvert-assessment-protocol.pdf>

Steckler, P., Lucey, K., Burdick, B., Glode, J., and Flanagan, S. 2017. New Hampshire's Tidal Crossing Assessment Protocol. The Nature Conservancy. Prepared for the New Hampshire Department of Environmental Services Coastal Program, Concord, NH.

Stream Visual Assessment Protocol Version 2, Part 614. National Biology Handbook Subpart B-Conservation Planning. United States Department of Agriculture, Natural Resources Conservation Service. 190-VI-NBH, December 2009.

https://www.nrcs.usda.gov/Internet/FSE_DOCUMENTS/nrcs144p2_042678.pdf

ATTACHMENT D
STREAM RESTORATION GRADING PLAN

STREAM RESTORATION NOTES:

1. FINAL STREAM DIVERSION/EROSION CONTROL PLANS SHALL BE PREPARED BY A PROFESSIONAL ENGINEER. THOSE PLANS SHALL DETAIL THE TIMING AND METHOD OF STREAM FLOW AND DIVERSION DURING CONSTRUCTION AND SHOW TEMPORARY SILTATION/EROSION/TURBIDITY CONTROL AND OTHER STABILIZATION MEASURES AND WATER QUALITY CONTROLS TO BE IMPLEMENTED.
2. LIMITS OF AUTHORIZED WORK WITHIN WETLAND AREAS ALONG THE TROLLEY CAR LANE STREAM RELOCATION SHALL BE IDENTIFIED AND MARKED PRIOR TO CONSTRUCTION.
3. EROSION AND SEDIMENT CONTROL MEASURES SHALL BE INSTALLED PRIOR TO ANY EARTH MOVING ACTIVITY THAT WILL INFLUENCE OR AFFECT STORMWATER RUNOFF.
4. THE STREAM CONSTRUCTION MONITORING SHALL BE PERFORMED BY AN INDIVIDUAL(S) WITH A COMBINATION OF EDUCATION AND EXPERIENCE, SUCH AS A FLUVIAL GEOMORPHOLOGIST OR HYDROLOGIST, WHO HAS KNOWLEDGE SUFFICIENT TO ENABLE THE INDIVIDUAL TO EVALUATE STREAM SYSTEMS. THE PERMITTEE SHALL NOTIFY NHDES OF THE NAME AND CONTACT INFORMATION OF THE QUALIFIED PROFESSIONAL(S) AND SHALL RE-NOTIFY NHDES OF ANY CHANGES OF QUALIFIED PROFESSIONAL(S).
5. EXISTING DESIRABLE SHRUBS IN AREAS TO BE FILLED OR DISTURBED BY CONSTRUCTION SHALL BE FLAGGED FOR SALVAGE. THESE PLANTS MAY BE EITHER INSTALLED IMMEDIATELY ALONG THE RELOCATED STREAM CHANNEL OR STOCKPILED IN A NEARBY SHADED LOCATION WITH ROOT SYSTEMS PROTECTED AND CARED FOR UNTIL INSTALLATION.
6. PLANT AND SOIL MATERIALS FROM LOCATIONS WITH INVASIVE SPECIES AS IDENTIFIED IN THE INVASIVE SPECIES CONTROL MANAGEMENT PLAN SHALL NOT BE REUSED ON SITE, BUT SHALL BE DISPOSED OF IN ACCORDANCE WITH NHDOT BEST MANAGEMENT PRACTICES FOR THE CONTROL OF INVASIVE AND NOXIOUS PLANT SPECIES (2018).
7. CLEAR AREAS ONLY AS NEEDED TO MEET THE REQUIREMENTS OF THE SPECIFIC RESTORATION/CONSTRUCTION TASK TO BE COMPLETED. INSTALL CONSTRUCTION FENCING TO PREVENT ACCIDENTAL DISTURBANCE OF AREAS OUTSIDE OF THE WORK AREA.
8. ALL SOIL MOVING EQUIPMENT SHALL BE THOROUGHLY CLEANED TO MAKE IT FREE OF SOIL, NON-NATIVE INVASIVE SPECIES OR OTHER DEBRIS THAT COULD CONTAIN OR HOLD SEEDS PRIOR TO BEING DELIVERED TO THE PROJECT SITE. EQUIPMENT SHALL BE CONSIDERED FREE OF NON-NATIVE OR INVASIVE SPECIES AND OTHER SUCH DEBRIS WHEN A VISUAL INSPECTION BY THE ENGINEER, COMPLETED PRIOR TO THE EQUIPMENT BEING MOVED TO THE SITE, DOES NOT DISCLOSE SUCH MATERIAL PRESENT.
9. NATIVE MATERIAL REMOVED FROM THE "TROLLEY CAR LANE STREAM" STREAM BED SHALL BE STOCKPILED SEPARATELY AND REUSED TO EMULATE A NATURAL CHANNEL BOTTOM WITHIN THE CHANNEL. MATERIALS USED TO EMULATE A NATURAL CHANNEL BOTTOM MUST BE CONSISTENT WITH THE STREAMBED MATERIALS IDENTIFIED IN THE REFERENCE REACH AND SHALL NOT INCLUDE ANGULAR RIPRAP OR GRAVEL UNLESS SPECIFICALLY IDENTIFIED ON THE APPROVED PLANS. ANY RIP RAP LOCATED ACROSS THE STREAM CHANNEL BED SHALL BE LOCATED SUBGRADE WITH STREAM BED SIMULATION AT THE CHANNEL BED SURFACE IN ORDER TO MAINTAIN LOW-FLOW AND NATURAL BED MATERIAL CONDITIONS.
10. NATIVE TOPSOIL IN LOCATIONS THAT ARE FREE FROM INVASIVE SPECIES MAY BE STOCKPILED AND REPLACED WITHIN THE BUFFER AREA TO TAKE ADVANTAGE OF THE AVAILABLE SEED BANK THESE SOILS CONTAIN.
11. SEGREGATE AND STOCKPILE THE EXCAVATED MATERIALS, SOIL MATERIALS AND DEBRIS. STOCKPILE (SEPARATELY) INVASIVE-FREE WETLAND SOIL, UPLAND SOIL, CHANNEL MATERIAL, BOULDERS AND LOGS, AND PROTECT WITH EROSION CONTROLS AS NEEDED. TEMPORARY STOCKPILE AREAS MUST NOT RESULT IN ADDITIONAL WETLAND OR STREAM IMPACTS BEYOND THOSE INCLUDED IN THE PROJECT WETLAND PERMITS.
12. ANY IMPORTED SOILS SHALL BE FREE OF INVASIVE PLANT MATERIAL, TOXIC SUBSTANCES, DEBRIS AND LARGE ROCKS AND BE SUITABLE FOR ESTABLISHING AND MAINTAINING NATIVE VEGETATION.
13. THE CONTRACTOR SHALL SUBMIT A WATER CONTROL PLAN (PLAN) FOR APPROVAL BY THE ENGINEER PRIOR TO MOBILIZATION. THE PLAN MUST DETAIL THE STEPS TO CONTROL, DIVERT AND RESTORE SURFACE WATER FLOW WITHIN THE PROJECT AREA. OVERALL, THE PLAN WILL BE THE CONTRACTOR'S PLAN THAT MEETS ALL PERMIT REQUIREMENTS AND IS SUBJECT TO APPROVAL BY THE ENGINEER.
14. THE CONTRACTOR SHALL MONITOR THE WEATHER, RAINFALL AND STORM WARNINGS ISSUED BY THE NATIONAL WEATHER SERVICE THROUGHOUT THE PROJECT AND SHALL REMOVE ALL EQUIPMENT AND MATERIALS THAT MAY BE AFFECTED BY FLOOD FLOWS FROM THE TROLLEY CAR LANE STREAM AREA.

STREAM CHANNEL/BANK CONSTRUCTION NOTES:

1. CHANNEL BED MATERIAL - SUITABLE EXCAVATED MATERIAL USED FOR CONSTRUCTION OF STREAM BED SHALL MEET THE GRADATION REQUIREMENTS AS FOLLOWS:
 - A. FINISHED STREAMBED MATERIALS IN THE INTERMITTENT REACHES SHALL HAVE A D50 OF APPROXIMATELY 1.0 MM WITH 50% OF VERY FINE TO MEDIUM SAND (0.062-1.0 MM) AND 50% OF COARSE TO VERY COARSE SAND (1.0-2.0 MM).
 - B. FINISHED STREAMBED MATERIALS IN THE PERENNIAL REACHES SHALL HAVE A D50 OF APPROXIMATELY 2.5 MM WITH 25% OF FINE AND VERY FINE SAND (0.062-0.25 MM), 20% OF COARSE TO VERY COARSE SAND (0.25-2.0 MM), 45% OF GRAVEL (2.0-64.0 MM) AND 10% OF COBBLE (64-180 MM).
2. CHANNEL BED MATERIALS SHALL CONSIST OF AN INERT MATERIAL THAT IS HARD, DURABLE STONE AND COARSE SAND FREE FROM LOAM, CLAY, SURFACE COATINGS AND DELETERIOUS MATERIALS. THE COLOR OF STONE USED FOR STREAMBED RECONSTRUCTION SHALL BE EITHER EARTH TONES OR MEDIUM TO DARK GRAY AND SHALL BE APPROVED BY THE ENGINEER PRIOR TO PLACEMENT.
3. GRADE CONTROLS WITHIN THE STREAM CHANNEL SHALL BE INSTALLED AS NOTED ON PLANS TO RE-CREATE RIFFLES AND POOLS. COBBLE/BOULDER WEIRS AND/OR LOGS EMBEDDED INTO THE STREAM CHANNEL AND BANKS SHALL BE USED FOR THIS PURPOSE. TO THE EXTENT POSSIBLE, BOULDERS AND LOGS FROM THE IMMEDIATE PROJECT AREA SHALL BE USED.
4. BOTH ARMS OF WEIR SHALL TIE INTO THE BANKS AT BANKFULL HEIGHT. THE CENTER OF THE STRUCTURE SHALL BE THE LOWEST PORTION OF THE STRUCTURE, SET BELOW BANKFULL HEIGHT.
5. THE OUTSIDE STREAM CURVES IN WETLAND AREAS WITHIN THE INTERMITTENT AND PERENNIAL REACHES SHALL BE STABILIZED WITH COIR BIOLOGS UP TO THE BANKFULL ELEVATION, ANCHORED INTO THE WETLAND SOIL. THE OUTSIDE STREAM CURVES IN UPLAND AREAS SHALL BE STABILIZED WITH BOULDERS AND COBBLES UP TO THE BANKFULL ELEVATION.
6. BANK ROCK PLACED ALONG CHANNEL BANKS SHALL BE SUB-ROUNDED TO ROUNDED RIVER STONE.

SDR PROCESSED	NEW DESIGN	SHEET CHECKED	AS BUILT DETAILS
DATE	DATE	DATE	DATE
NUMBER	DATE	STATION	STATION
DESCRIPTION	REVISIONS AFTER PROPOSAL		

DATE 4/28/2020
 DATE 4/28/2020



STATE OF NEW HAMPSHIRE			
DEPARTMENT OF TRANSPORTATION • BUREAU OF HIGHWAY DESIGN			
TROLLEY CAR LANE STREAM NOTES			
DGN	STATE PROJECT NO.	SHEET NO.	TOTAL SHEETS
13065GRADE-NOTES	13065	1	6

SDR PROCESSED	DATE	DATE	DATE	DATE	DATE	DATE
NEW DESIGN	LEC/SRB	4/28/2020	4/28/2020	4/28/2020	4/28/2020	4/28/2020
SHEET CHECKED	ETC/NCF					
AS BUILT DETAILS						

REVISIONS AFTER PROPOSAL

STATION

STATION

DATE

NUMBER

DESCRIPTION

PLANTING TABLE

Common Name	Scientific Name	Status	Spacing	Plant Size/Type	Quantity	Location
Red Maple	<i>Acer rubrum</i>	FAC	15-20 feet	3-6 ft/Potted/Salvaged	40	Wetland/Upland Buffer
Yellow birch	<i>Betula allegheniensis</i>	FAC	15-20 feet	3-6 ft/Potted/Salvaged	40	Wetland/Upland Buffer
Ironwood	<i>Carpinus caroliniana</i>	FAC	10-15 feet	3-6 ft/Potted/Salvaged	50	Wetland/Upland Buffer
Speckled alder	<i>Alnus incana</i>	FACW	3-6 feet	2-3 ft/Potted/Salvaged	250	Wetland Buffer
Silky dogwood	<i>Cornus amomum</i>	FACW	3-6 feet	2-3 ft/Potted/Salvaged	150	Wetland/Upland Buffer
Spicebush	<i>Lindera benzoin</i>	FACW	3-6 feet	2-3 ft/Potted/Salvaged	150	Wetland Buffer
Black elderberry	<i>Sambucus nigra</i>	FACW	3-6 feet	2-3 ft/Potted/Salvaged	150	Wetland Buffer
Silky dogwood	<i>Cornus amomum</i>	FACW	2-3 feet	Live stakes*	550	Streambank
Pussy Willow	<i>Salix discolor</i>	FACW	2-3 feet	Live stakes*	550	Streambank
Black elderberry	<i>Sambucus nigra</i>	FACW	2-3 feet	Live stakes*	550	Streambank
NE erosion control/restoration mix for moist sites			35lbs/acre	hydro-seed, broadcast	17 lbs	Wetland Buffer/Streambank
NE Erosion control/restoration mix for dry sites ²			35lbs/acre	hydro-seed, broadcast	9 lbs	Upland Buffer
Coir Logs for Streambank Stabilization				540	lf	Wetland Outer Streambank
Boulders for Steambank stabilization				290	lf	Upland Outer Streambank

* Live stakes are only available for purchase or cutting and installation in November-March

CONSTRUCTION SEQUENCE:

- INSTALL EROSION AND SEDIMENTATION CONTROLS
- FLAG DESIRABLE SHRUBS AND SAPLINGS FOR SALVAGE
- STOCKPILE SALVAGED PLANT/SOIL MATERIALS
- EXCAVATE NEW CHANNEL
- GRADE AND INSTALL NEW/SALVAGED STREAM CHANNEL MATERIALS
- REPLACE/AUGMENT BUFFER AND BANK SOILS
- FINAL GRADE WORK AREA/BUFFER
- APPLY EROSION CONTROL JUTE AND SEED
- INTRODUCE STREAMFLOW GRADUALLY INTO NEW CHANNEL
- INSTALL STREAMBANK AND BUFFER PLANTINGS (IMMEDIATELY FOR SALVAGED/CONTAINER PLANTS; NOVEMBER TO MARCH FOR LIVE STAKES)
- INITIATE POST-CONSTRUCTION MONITORING (SEE MONITORING PLAN)
- REMOVE TEMPORARY EROSION AND SEDIMENTATION CONTROLS WHEN SOILS ARE STABLE

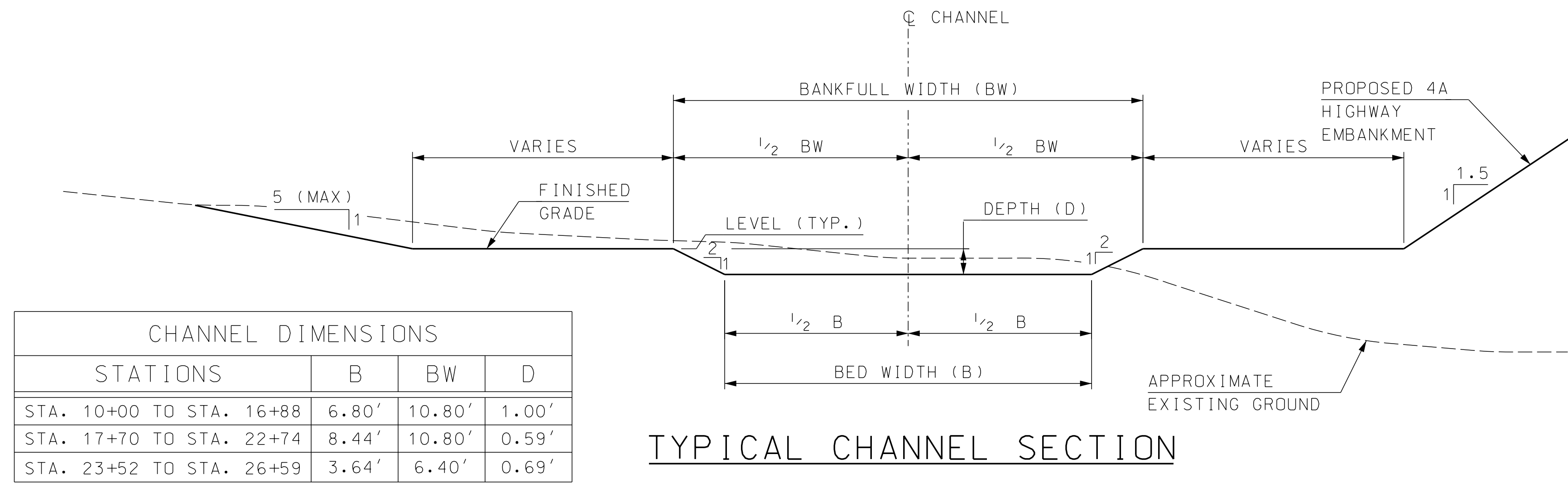

STATE OF NEW HAMPSHIRE			
DEPARTMENT OF TRANSPORTATION • BUREAU OF HIGHWAY DESIGN			
TROLLEY CAR LANE STREAM PLANTING TABLE & SECTION			
DGN	STATE PROJECT NO.	SHEET NO.	TOTAL SHEETS
13065GRADE-NOTES	13065	2	6

SDR PROCESSED		DATE		DATE		DATE		DATE	
NEW DESIGN		LES/SRB		2/6/2020		2/6/2020		2/6/2020	
SHEET CHECKED		ETC/NCF							
AS BUILT DETAILS									

REVISIONS AFTER PROPOSAL	STATION	DESCRIPTION

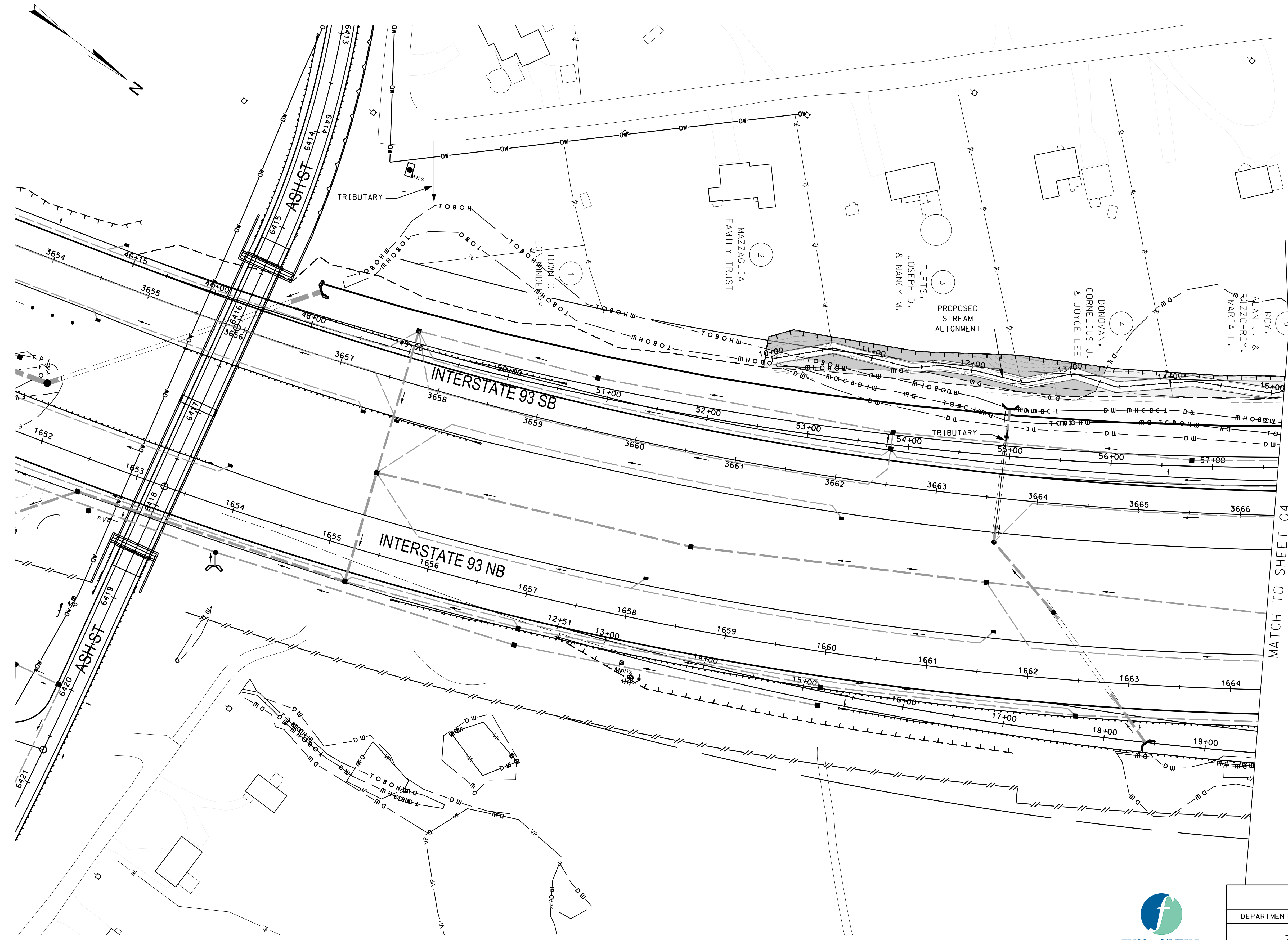

MATCH TO SHEET 04



LEGEND

	RESTORED WETLAND
	RESTORED UPLAND

CHANNEL GRADE CONTROL FEATURE LOCATIONS

STATION
22+75 TO 23+52
17+70 TO 20+82
11+64 TO 20+82
10+00 TO 10+50



STATE OF NEW HAMPSHIRE			
DEPARTMENT OF TRANSPORTATION • BUREAU OF HIGHWAY DESIGN			
TROLLEY CAR LANE STREAM GRADING PLAN			
DGN	STATE PROJECT NO.	SHEET NO.	TOTAL SHEETS
13065GRADE	13065	3	6

SDR PROCESSED	DATE	2/6/2020
NEW DESIGN	DATE	2/6/2020
SHEET CHECKED	DATE	2/6/2020
AS BUILT DETAILS	DATE	

REVISIONS AFTER PROPOSAL	DESCRIPTION	STATION

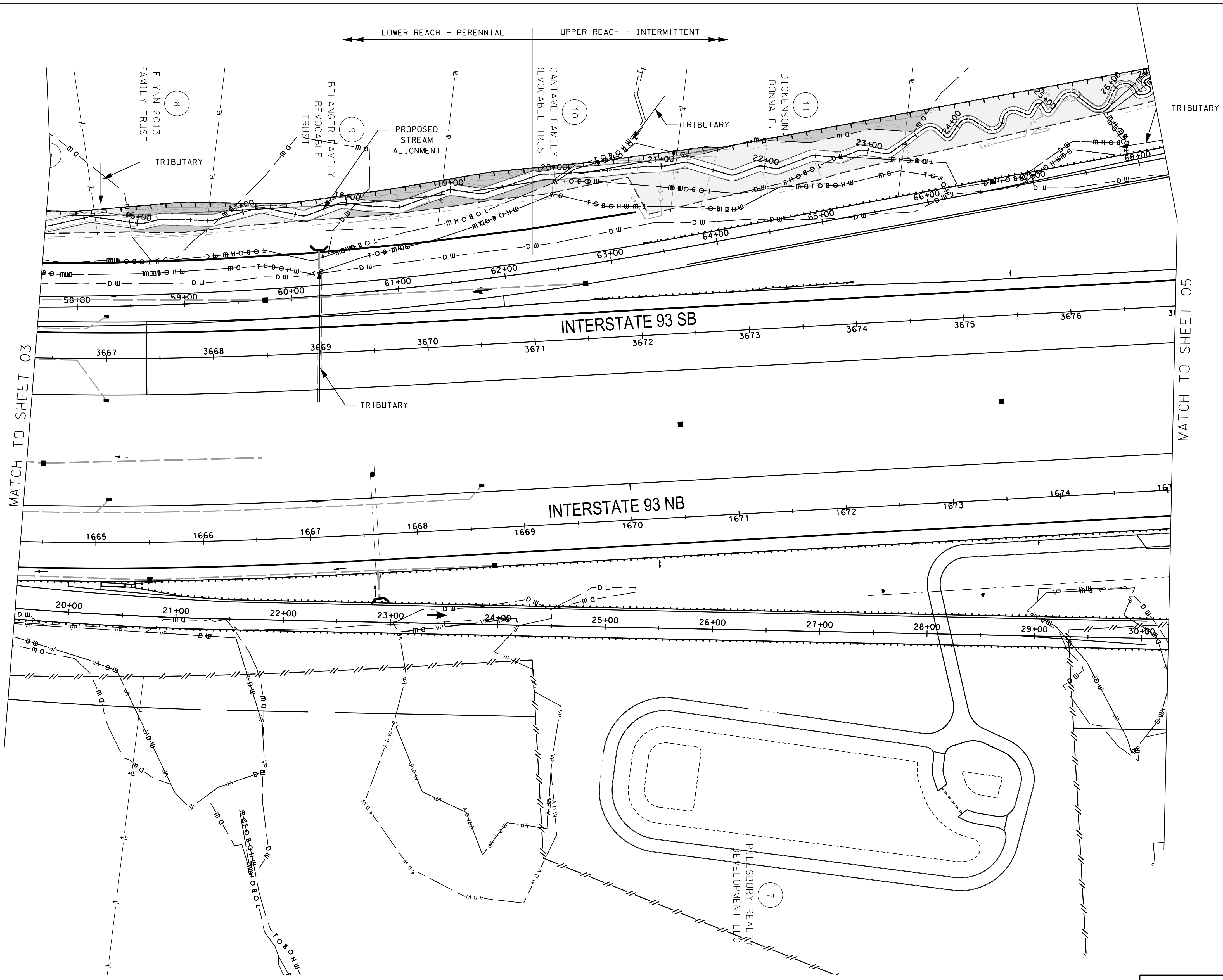
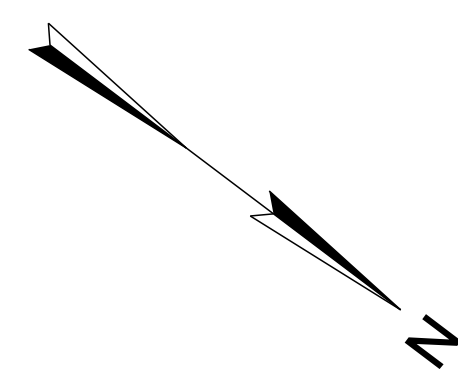

MATCH TO SHEET 03

MATCH TO SHEET 05



LEGEND	
	RESTORED WETLAND
	RESTORED UPLAND



STATE OF NEW HAMPSHIRE			
DEPARTMENT OF TRANSPORTATION • BUREAU OF HIGHWAY DESIGN			
TROLLEY CAR LANE STREAM GRADING PLAN			
DGN	STATE PROJECT NO.	SHEET NO.	TOTAL SHEETS
13065GRADE	13065	4	6

SDR PROCESSED	DATE	2/6/2020
NEW DESIGN	LES/SRB	DATE
SHEET CHECKED	ETC/NCF	DATE
AS BUILT DETAILS	DATE	

REVISIONS AFTER PROPOSAL	DESCRIPTION	STATION

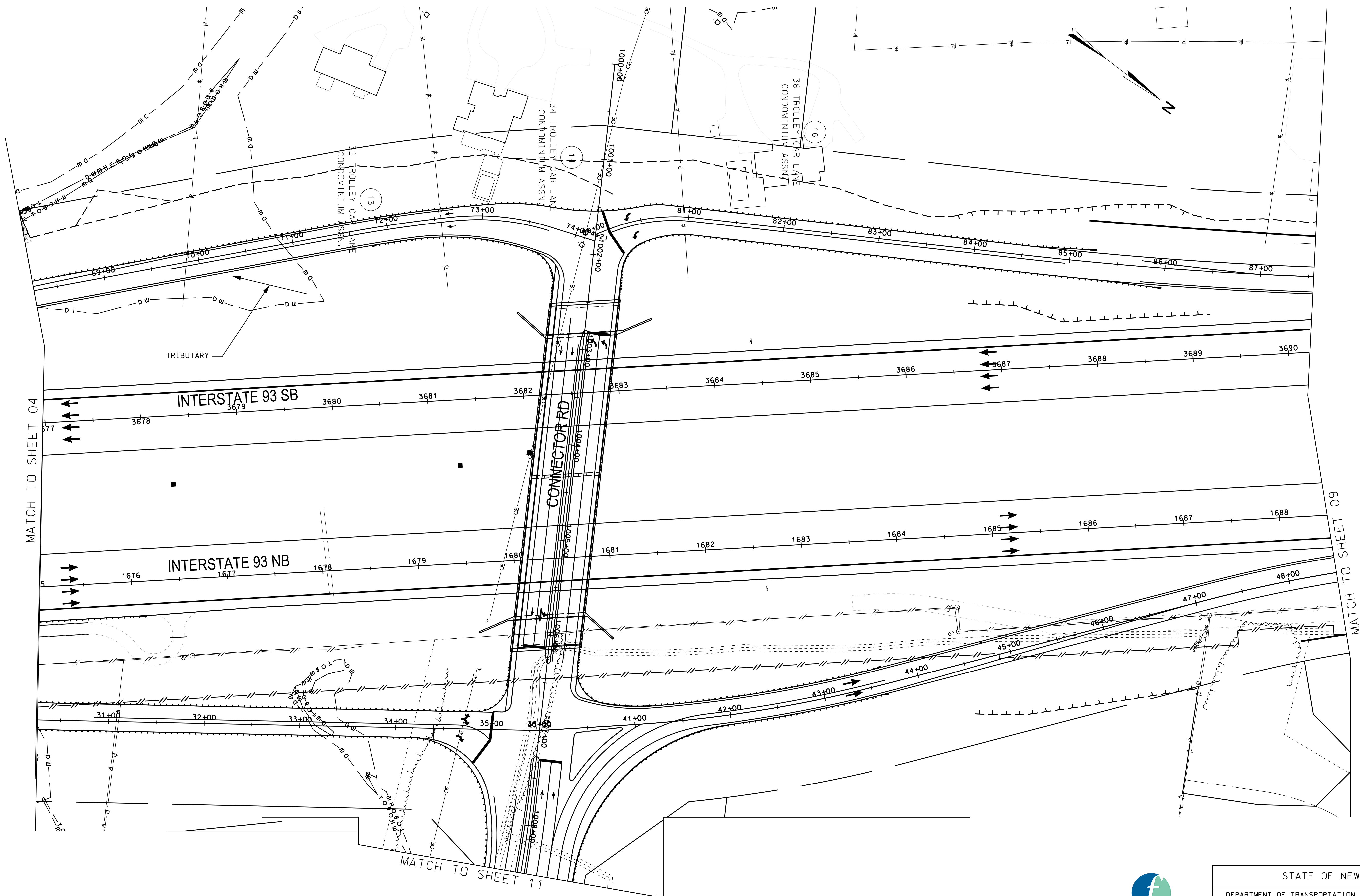

LEGEND

	RESTORED WETLAND
	RESTORED UPLAND

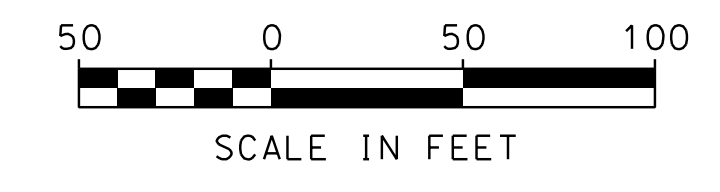

STATE OF NEW HAMPSHIRE			
DEPARTMENT OF TRANSPORTATION • BUREAU OF HIGHWAY DESIGN			
TROLLEY CAR LANE STREAM GRADING PLAN			
DGN	STATE PROJECT NO.	SHEET NO.	TOTAL SHEETS
13065GRADE	13065	5	6

SDR PROCESSED		DATE		REVISIONS AFTER PROPOSAL	
NEW DESIGN	LEC/SRB	DATE	4/28/2020	STATION	DESCRIPTION
SHEET CHECKED	ETC/NCF	DATE	4/28/2020	NUMBER	DATE
AS BUILT DETAILS		DATE			

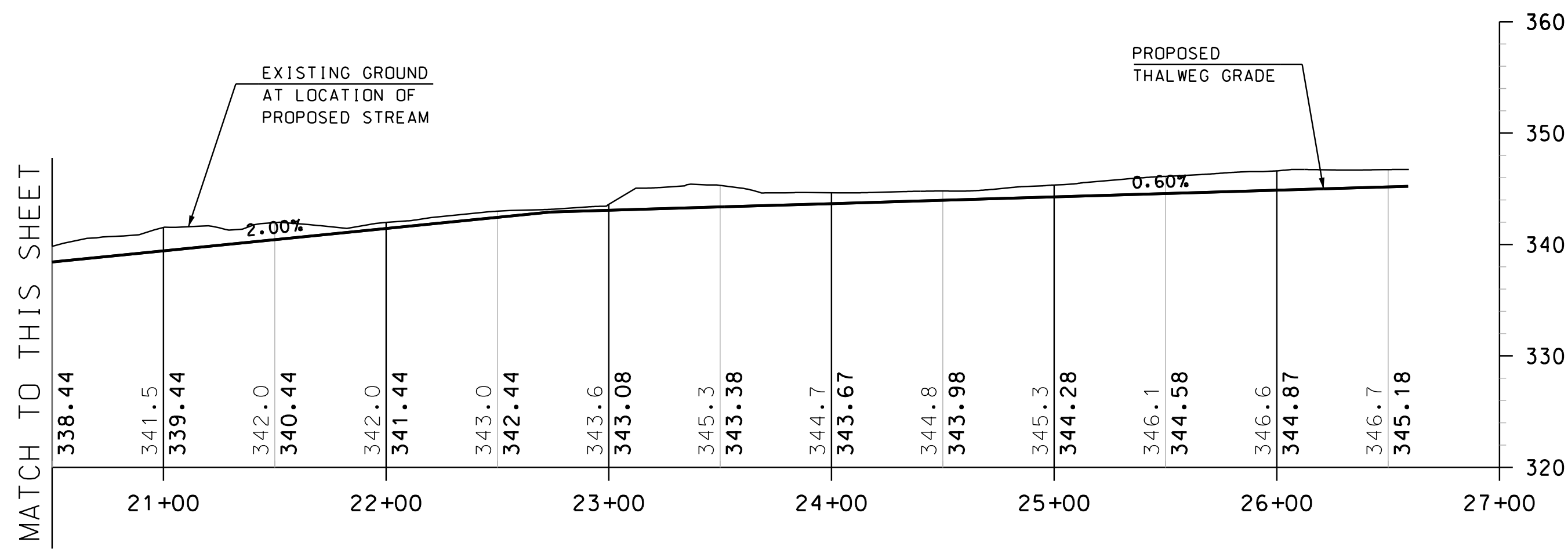
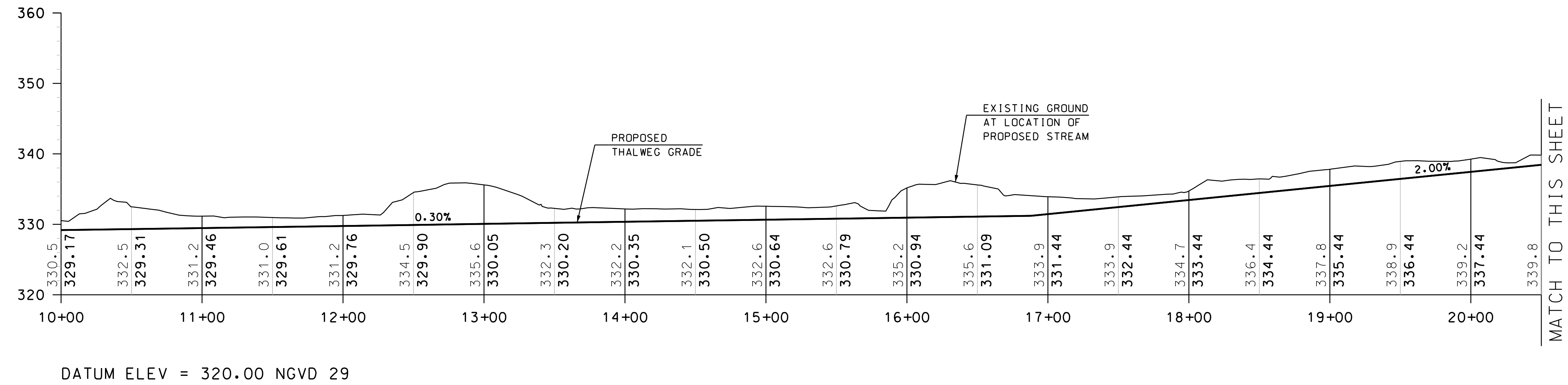

TROLLEY CAR LANE STREAM PROFILE

SCALE:
 1" = 50' HORIZ.
 1" = 10' VERT.

NOTE: THE EXISTING GROUND SHOWN IN THE PROFILE IS LOCATED AT THE LOCATION OF THE RELOCATED STREAM AND DOES NOT REFLECT THE EXISTING STREAM PROFILE



STATE OF NEW HAMPSHIRE			
DEPARTMENT OF TRANSPORTATION • BUREAU OF HIGHWAY DESIGN			
TROLLEY CAR LANE STREAM PROFILE			
DGN	STATE PROJECT NO.	SHEET NO.	TOTAL SHEETS
13065GRADE-PROF ILE	13065	6	6

ATTACHMENT E

HYDROCAD™ ROUTING DIAGRAM AND FLOW LOCATIONS

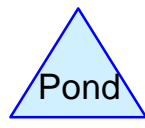
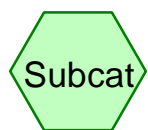
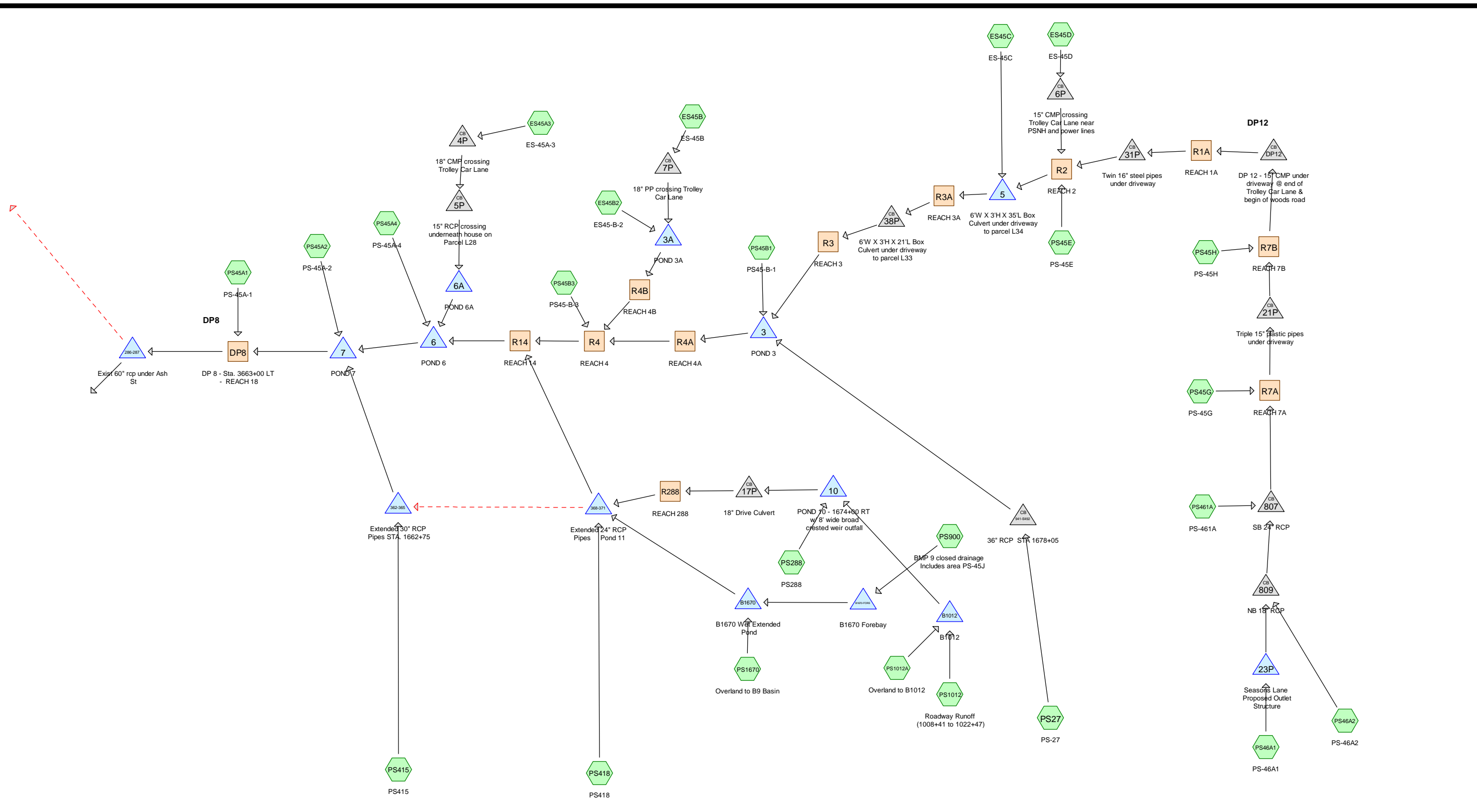

Routing Diagram for 2h1_Hycd_14633D&I_Exit 4A Proposed_Conditions

Prepared by Fuss & O'Neill, Printed 4/28/2020

HydroCAD® 10.00-21 s/n 10611 © 2018 HydroCAD Software Solutions LLC

SDR PROCESSED	DATE	2/6/2020
NEW DESIGN	DATE	2/6/2020
SHEET CHECKED	DATE	2/6/2020
AS BUILT DETAILS	DATE	

REVISIONS AFTER PROPOSAL	STATION	DESCRIPTION

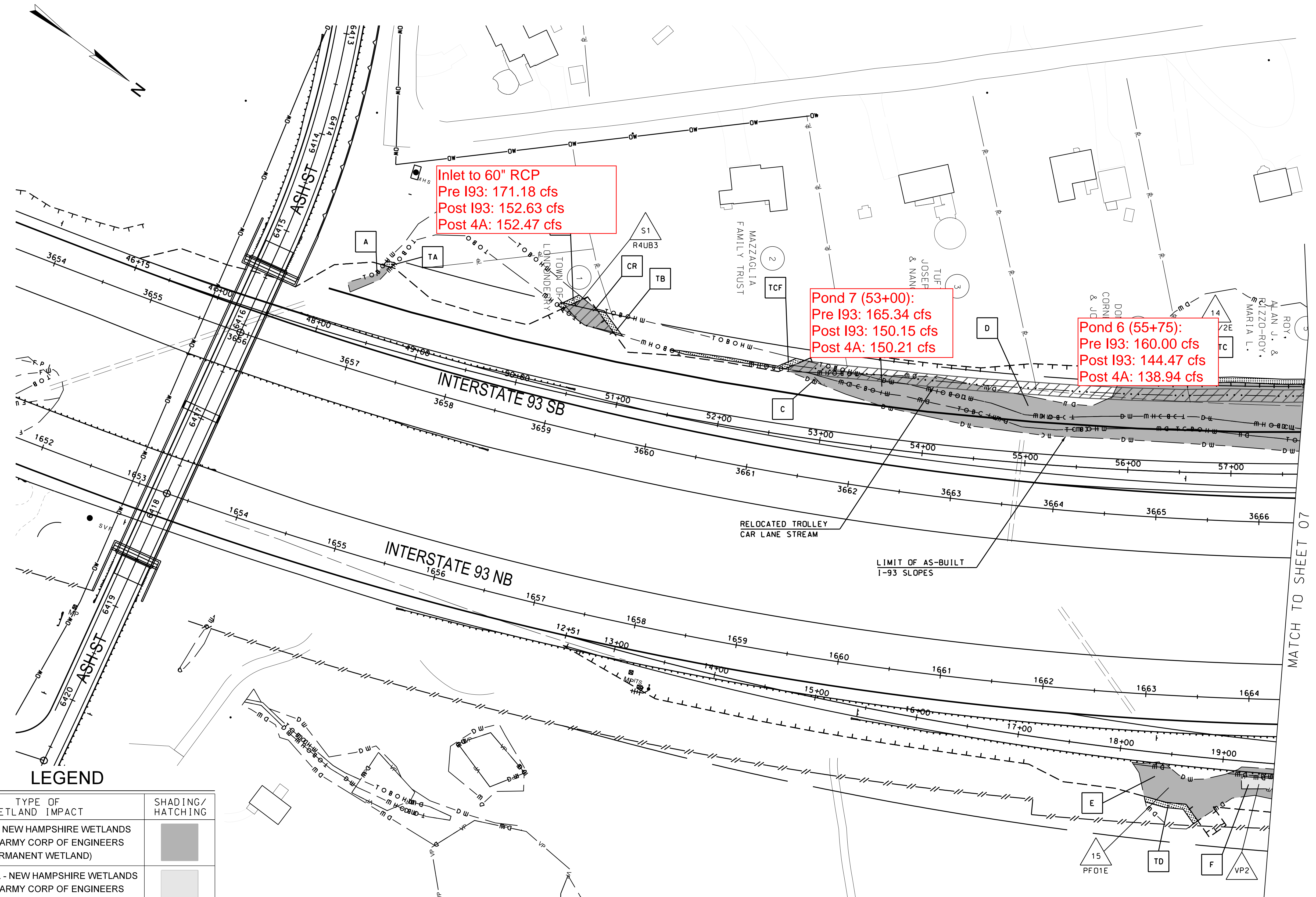

Inlet to 60" RCP
 Pre I93: 171.18 cfs
 Post I93: 152.63 cfs
 Post 4A: 152.47 cfs

Pond 7 (53+00):
 Pre I93: 165.34 cfs
 Post I93: 150.15 cfs
 Post 4A: 150.21 cfs

Pond 6 (55+75):
 Pre I93: 160.00 cfs
 Post I93: 144.47 cfs
 Post 4A: 138.94 cfs

LEGEND

TYPE OF WETLAND IMPACT	SHADING/HATCHING
WETLANDS - NEW HAMPSHIRE WETLANDS BUREAU & ARMY CORP OF ENGINEERS (PERMANENT WETLAND)	
VERNAL POOL - NEW HAMPSHIRE WETLANDS BUREAU & ARMY CORP OF ENGINEERS (PERMANENT WETLAND)	
NEW HAMPSHIRE WETLANDS BUREAU & ARMY CORP OF ENGINEERS (TEMPORARY WETLAND)	
RELOCATED STREAM SELF MITIGATING	



STATE OF NEW HAMPSHIRE			
DEPARTMENT OF TRANSPORTATION • BUREAU OF HIGHWAY DESIGN			
WETLAND IMPACT PLAN			
DGN 13065WETL	STATE PROJECT NO. 13065	SHEET NO. 6	TOTAL SHEETS 28

MATCH TO SHEET 07

REVISIONS AFTER PROPOSAL	STATION	DESCRIPTION

NUMBER	DATE	STATION

DATE	DATE	DATE	DATE
SDR PROCESSED	2/6/2020		
NEW DESIGN	2/6/2020		
SHEET CHECKED			
AS BUILT DETAILS			

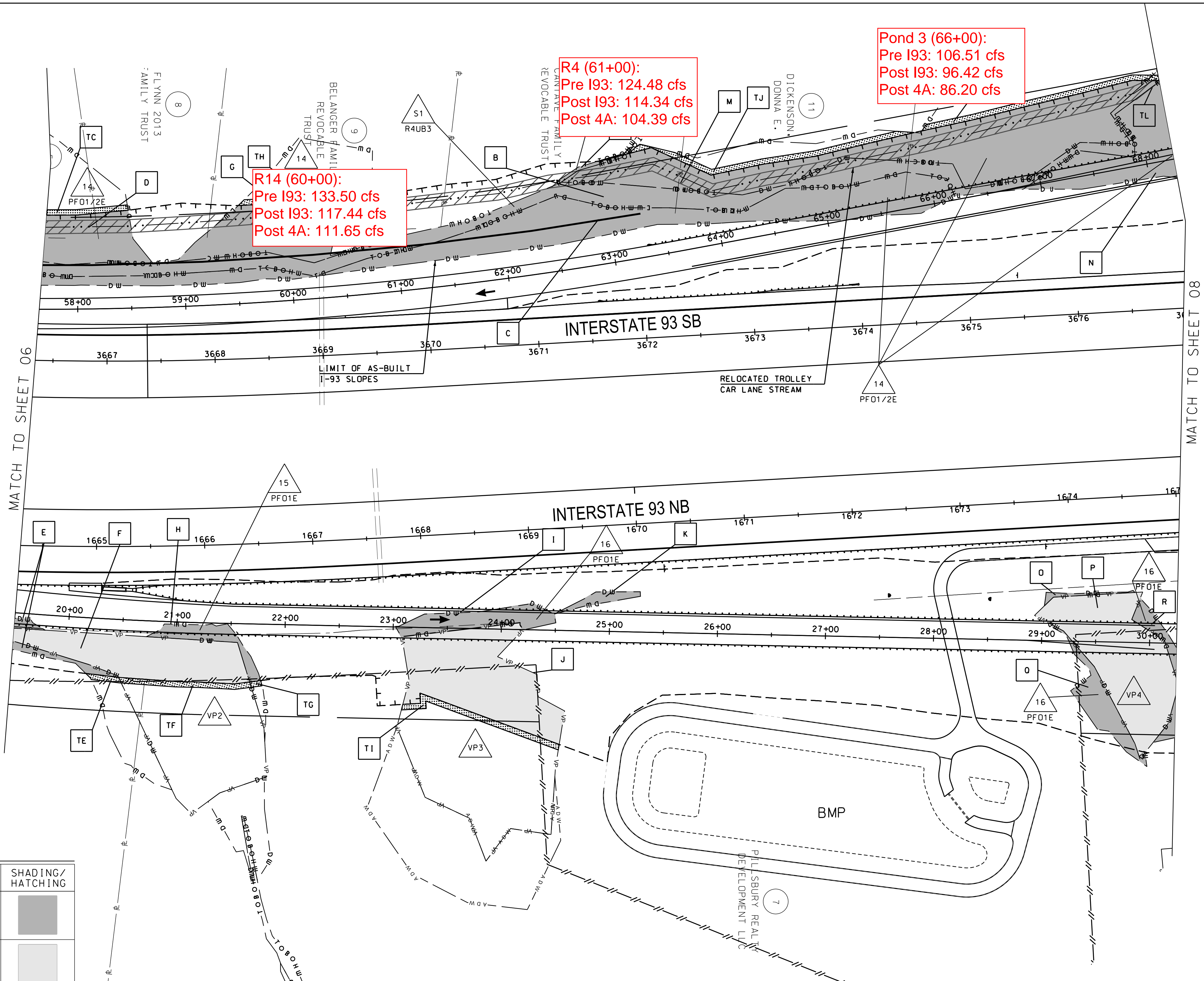
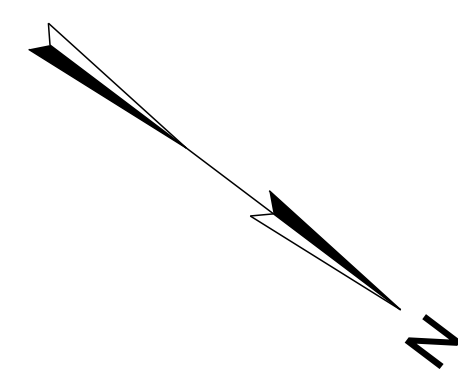

R14 (60+00):
Pre I93: 133.50 cfs
Post I93: 117.44 cfs
Post 4A: 111.65 cfs

R4 (61+00):
Pre I93: 124.48 cfs
Post I93: 114.34 cfs
Post 4A: 104.39 cfs

Pond 3 (66+00):
Pre I93: 106.51 cfs
Post I93: 96.42 cfs
Post 4A: 86.20 cfs

LEGEND

TYPE OF WETLAND IMPACT	SHADING/HATCHING
WETLANDS - NEW HAMPSHIRE WETLANDS BUREAU & ARMY CORP OF ENGINEERS (PERMANENT WETLAND)	
VERNAL POOL - NEW HAMPSHIRE WETLANDS BUREAU & ARMY CORP OF ENGINEERS (PERMANENT WETLAND)	
NEW HAMPSHIRE WETLANDS BUREAU & ARMY CORP OF ENGINEERS (TEMPORARY WETLAND)	
RELOCATED STREAM SELF MITIGATING	



STATE OF NEW HAMPSHIRE			
DEPARTMENT OF TRANSPORTATION • BUREAU OF HIGHWAY DESIGN			
WETLAND IMPACT PLAN			
DGN	STATE PROJECT NO.	SHEET NO.	TOTAL SHEETS
13065WETL	13065	7	28

STREAM RESTORATION NOTES:

1. FINAL STREAM DIVERSION/EROSION CONTROL PLANS SHALL BE PREPARED BY A PROFESSIONAL ENGINEER. THOSE PLANS SHALL DETAIL THE TIMING AND METHOD OF STREAM FLOW AND DIVERSION DURING CONSTRUCTION AND SHOW TEMPORARY SILTATION/EROSION/TURBIDITY CONTROL AND OTHER STABILIZATION MEASURES AND WATER QUALITY CONTROLS TO BE IMPLEMENTED.
2. LIMITS OF AUTHORIZED WORK WITHIN WETLAND AREAS ALONG THE TROLLEY CAR LANE STREAM RELOCATION SHALL BE IDENTIFIED AND MARKED PRIOR TO CONSTRUCTION.
3. EROSION AND SEDIMENT CONTROL MEASURES SHALL BE INSTALLED PRIOR TO ANY EARTH MOVING ACTIVITY THAT WILL INFLUENCE OR AFFECT STORMWATER RUNOFF.
4. THE STREAM CONSTRUCTION MONITORING SHALL BE PERFORMED BY AN INDIVIDUAL(S) WITH A COMBINATION OF EDUCATION AND EXPERIENCE, SUCH AS A FLUVIAL GEOMORPHOLOGIST OR HYDROLOGIST, WHO HAS KNOWLEDGE SUFFICIENT TO ENABLE THE INDIVIDUAL TO EVALUATE STREAM SYSTEMS. THE PERMITTEE SHALL NOTIFY NHDES OF THE NAME AND CONTACT INFORMATION OF THE QUALIFIED PROFESSIONAL(S) AND SHALL RE-NOTIFY NHDES OF ANY CHANGES OF QUALIFIED PROFESSIONAL(S).
5. EXISTING DESIRABLE SHRUBS IN AREAS TO BE FILLED OR DISTURBED BY CONSTRUCTION SHALL BE FLAGGED FOR SALVAGE. THESE PLANTS MAY BE EITHER INSTALLED IMMEDIATELY ALONG THE RELOCATED STREAM CHANNEL OR STOCKPILED IN A NEARBY SHADED LOCATION WITH ROOT SYSTEMS PROTECTED AND CARED FOR UNTIL INSTALLATION.
6. PLANT AND SOIL MATERIALS FROM LOCATIONS WITH INVASIVE SPECIES AS IDENTIFIED IN THE INVASIVE SPECIES CONTROL MANAGEMENT PLAN SHALL NOT BE REUSED ON SITE, BUT SHALL BE DISPOSED OF IN ACCORDANCE WITH NHDOT BEST MANAGEMENT PRACTICES FOR THE CONTROL OF INVASIVE AND NOXIOUS PLANT SPECIES (2018).
7. CLEAR AREAS ONLY AS NEEDED TO MEET THE REQUIREMENTS OF THE SPECIFIC RESTORATION/CONSTRUCTION TASK TO BE COMPLETED. INSTALL CONSTRUCTION FENCING TO PREVENT ACCIDENTAL DISTURBANCE OF AREAS OUTSIDE OF THE WORK AREA.
8. ALL SOIL MOVING EQUIPMENT SHALL BE THOROUGHLY CLEANED TO MAKE IT FREE OF SOIL, NON-NATIVE INVASIVE SPECIES OR OTHER DEBRIS THAT COULD CONTAIN OR HOLD SEEDS PRIOR TO BEING DELIVERED TO THE PROJECT SITE. EQUIPMENT SHALL BE CONSIDERED FREE OF NON-NATIVE OR INVASIVE SPECIES AND OTHER SUCH DEBRIS WHEN A VISUAL INSPECTION BY THE ENGINEER, COMPLETED PRIOR TO THE EQUIPMENT BEING MOVED TO THE SITE, DOES NOT DISCLOSE SUCH MATERIAL PRESENT.
9. NATIVE MATERIAL REMOVED FROM THE "TROLLEY CAR LANE STREAM" STREAM BED SHALL BE STOCKPILED SEPARATELY AND REUSED TO EMULATE A NATURAL CHANNEL BOTTOM WITHIN THE CHANNEL. MATERIALS USED TO EMULATE A NATURAL CHANNEL BOTTOM MUST BE CONSISTENT WITH THE STREAMBED MATERIALS IDENTIFIED IN THE REFERENCE REACH AND SHALL NOT INCLUDE ANGULAR RIPRAP OR GRAVEL UNLESS SPECIFICALLY IDENTIFIED ON THE APPROVED PLANS. ANY RIP RAP LOCATED ACROSS THE STREAM CHANNEL BED SHALL BE LOCATED SUBGRADE WITH STREAM BED SIMULATION AT THE CHANNEL BED SURFACE IN ORDER TO MAINTAIN LOW-FLOW AND NATURAL BED MATERIAL CONDITIONS.
10. NATIVE TOPSOIL IN LOCATIONS THAT ARE FREE FROM INVASIVE SPECIES MAY BE STOCKPILED AND REPLACED WITHIN THE BUFFER AREA TO TAKE ADVANTAGE OF THE AVAILABLE SEED BANK THESE SOILS CONTAIN.
11. SEGREGATE AND STOCKPILE THE EXCAVATED MATERIALS, SOIL MATERIALS AND DEBRIS. STOCKPILE (SEPARATELY) INVASIVE-FREE WETLAND SOIL, UPLAND SOIL, CHANNEL MATERIAL, BOULDERS AND LOGS, AND PROTECT WITH EROSION CONTROLS AS NEEDED. TEMPORARY STOCKPILE AREAS MUST NOT RESULT IN ADDITIONAL WETLAND OR STREAM IMPACTS BEYOND THOSE INCLUDED IN THE PROJECT WETLAND PERMITS.
12. ANY IMPORTED SOILS SHALL BE FREE OF INVASIVE PLANT MATERIAL, TOXIC SUBSTANCES, DEBRIS AND LARGE ROCKS AND BE SUITABLE FOR ESTABLISHING AND MAINTAINING NATIVE VEGETATION.
13. THE CONTRACTOR SHALL SUBMIT A WATER CONTROL PLAN (PLAN) FOR APPROVAL BY THE ENGINEER PRIOR TO MOBILIZATION. THE PLAN MUST DETAIL THE STEPS TO CONTROL, DIVERT AND RESTORE SURFACE WATER FLOW WITHIN THE PROJECT AREA. OVERALL, THE PLAN WILL BE THE CONTRACTOR'S PLAN THAT MEETS ALL PERMIT REQUIREMENTS AND IS SUBJECT TO APPROVAL BY THE ENGINEER.
14. THE CONTRACTOR SHALL MONITOR THE WEATHER, RAINFALL AND STORM WARNINGS ISSUED BY THE NATIONAL WEATHER SERVICE THROUGHOUT THE PROJECT AND SHALL REMOVE ALL EQUIPMENT AND MATERIALS THAT MAY BE AFFECTED BY FLOOD FLOWS FROM THE TROLLEY CAR LANE STREAM AREA.

STREAM CHANNEL/BANK CONSTRUCTION NOTES:

1. CHANNEL BED MATERIAL - SUITABLE EXCAVATED MATERIAL USED FOR CONSTRUCTION OF STREAM BED SHALL MEET THE GRADATION REQUIREMENTS AS FOLLOWS:
 - A. FINISHED STREAMBED MATERIALS IN THE INTERMITTENT REACHES SHALL HAVE A D50 OF APPROXIMATELY 1.0 MM WITH 50% OF VERY FINE TO MEDIUM SAND (0.062-1.0 MM) AND 50% OF COARSE TO VERY COARSE SAND (1.0-2.0 MM).
 - B. FINISHED STREAMBED MATERIALS IN THE PERENNIAL REACHES SHALL HAVE A D50 OF APPROXIMATELY 2.5 MM WITH 25% OF FINE AND VERY FINE SAND (0.062-0.25 MM), 20% OF COARSE TO VERY COARSE SAND (0.25-2.0 MM), 45% OF GRAVEL (2.0-64.0 MM) AND 10% OF COBBLE (64-180 MM).
2. CHANNEL BED MATERIALS SHALL CONSIST OF AN INERT MATERIAL THAT IS HARD, DURABLE STONE AND COARSE SAND FREE FROM LOAM, CLAY, SURFACE COATINGS AND DELETERIOUS MATERIALS. THE COLOR OF STONE USED FOR STREAMBED RECONSTRUCTION SHALL BE EITHER EARTH TONES OR MEDIUM TO DARK GRAY AND SHALL BE APPROVED BY THE ENGINEER PRIOR TO PLACEMENT.
3. GRADE CONTROLS WITHIN THE STREAM CHANNEL SHALL BE INSTALLED AS NOTED ON PLANS TO RE-CREATE RIFFLES AND POOLS. COBBLE/BOULDER WEIRS AND/OR LOGS EMBEDDED INTO THE STREAM CHANNEL AND BANKS SHALL BE USED FOR THIS PURPOSE. TO THE EXTENT POSSIBLE, BOULDERS AND LOGS FROM THE IMMEDIATE PROJECT AREA SHALL BE USED.
4. BOTH ARMS OF WEIR SHALL TIE INTO THE BANKS AT BANKFULL HEIGHT. THE CENTER OF THE STRUCTURE SHALL BE THE LOWEST PORTION OF THE STRUCTURE, SET BELOW BANKFULL HEIGHT.
5. THE OUTSIDE STREAM CURVES IN WETLAND AREAS WITHIN THE INTERMITTENT AND PERENNIAL REACHES SHALL BE STABILIZED WITH COIR BIOLOGS UP TO THE BANKFULL ELEVATION, ANCHORED INTO THE WETLAND SOIL. THE OUTSIDE STREAM CURVES IN UPLAND AREAS SHALL BE STABILIZED WITH BOULDERS AND COBBLES UP TO THE BANKFULL ELEVATION.
6. BANK ROCK PLACED ALONG CHANNEL BANKS SHALL BE SUB-ROUNDED TO ROUNDED RIVER STONE.

SDR PROCESSED	NEW DESIGN	LEC/SRB	DATE	4/28/2020
	SHEET CHECKED	ETC/NCF	DATE	4/28/2020
	AS BUILT DETAILS			
	DATE			

REVISIONS AFTER PROPOSAL	DESCRIPTION	STATION
	STATION	STATION
	DATE	
	NUMBER	



STATE OF NEW HAMPSHIRE			
DEPARTMENT OF TRANSPORTATION • BUREAU OF HIGHWAY DESIGN			
TROLLEY CAR LANE STREAM NOTES			
DGN	STATE PROJECT NO.	SHEET NO.	TOTAL SHEETS
13065GRADE-NOTES	13065	1	6

SDR PROCESSED	DATE	DATE	DATE	DATE	DATE	DATE
NEW DESIGN	LEC/SRB	4/28/2020	4/28/2020	4/28/2020	4/28/2020	4/28/2020
SHEET CHECKED	ETC/NCF					
AS BUILT DETAILS						

REVISIONS AFTER PROPOSAL

STATION

STATION

DATE

NUMBER

DESCRIPTION

PLANTING TABLE

Common Name	Scientific Name	Status	Spacing	Plant Size/Type	Quantity	Location
Red Maple	<i>Acer rubrum</i>	FAC	15-20 feet	3-6 ft/Potted/Salvaged	40	Wetland/Upland Buffer
Yellow birch	<i>Betula allegheniensis</i>	FAC	15-20 feet	3-6 ft/Potted/Salvaged	40	Wetland/Upland Buffer
Ironwood	<i>Carpinus caroliniana</i>	FAC	10-15 feet	3-6 ft/Potted/Salvaged	50	Wetland/Upland Buffer
Speckled alder	<i>Alnus incana</i>	FACW	3-6 feet	2-3 ft/Potted/Salvaged	250	Wetland Buffer
Silky dogwood	<i>Cornus amomum</i>	FACW	3-6 feet	2-3 ft/Potted/Salvaged	150	Wetland/Upland Buffer
Spicebush	<i>Lindera benzoin</i>	FACW	3-6 feet	2-3 ft/Potted/Salvaged	150	Wetland Buffer
Black elderberry	<i>Sambucus nigra</i>	FACW	3-6 feet	2-3 ft/Potted/Salvaged	150	Wetland Buffer
Silky dogwood	<i>Cornus amomum</i>	FACW	2-3 feet	Live stakes*	550	Streambank
Pussy Willow	<i>Salix discolor</i>	FACW	2-3 feet	Live stakes*	550	Streambank
Black elderberry	<i>Sambucus nigra</i>	FACW	2-3 feet	Live stakes*	550	Streambank
NE erosion control/restoration mix for moist sites			35lbs/acre	hydro-seed, broadcast	17 lbs	Wetland Buffer/Streambank
NE Erosion control/restoration mix for dry sites ²			35lbs/acre	hydro-seed, broadcast	9 lbs	Upland Buffer
Coir Logs for Streambank Stabilization				540	lf	Wetland Outer Streambank
Boulders for Steambank stabilization				290	lf	Upland Outer Streambank

* Live stakes are only available for purchase or cutting and installation in November-March

CONSTRUCTION SEQUENCE:

- INSTALL EROSION AND SEDIMENTATION CONTROLS
- FLAG DESIRABLE SHRUBS AND SAPLINGS FOR SALVAGE
- STOCKPILE SALVAGED PLANT/SOIL MATERIALS
- EXCAVATE NEW CHANNEL
- GRADE AND INSTALL NEW/SALVAGED STREAM CHANNEL MATERIALS
- REPLACE/AUGMENT BUFFER AND BANK SOILS
- FINAL GRADE WORK AREA/BUFFER
- APPLY EROSION CONTROL JUTE AND SEED
- INTRODUCE STREAMFLOW GRADUALLY INTO NEW CHANNEL
- INSTALL STREAMBANK AND BUFFER PLANTINGS (IMMEDIATELY FOR SALVAGED/CONTAINER PLANTS; NOVEMBER TO MARCH FOR LIVE STAKES)
- INITIATE POST-CONSTRUCTION MONITORING (SEE MONITORING PLAN)
- REMOVE TEMPORARY EROSION AND SEDIMENTATION CONTROLS WHEN SOILS ARE STABLE

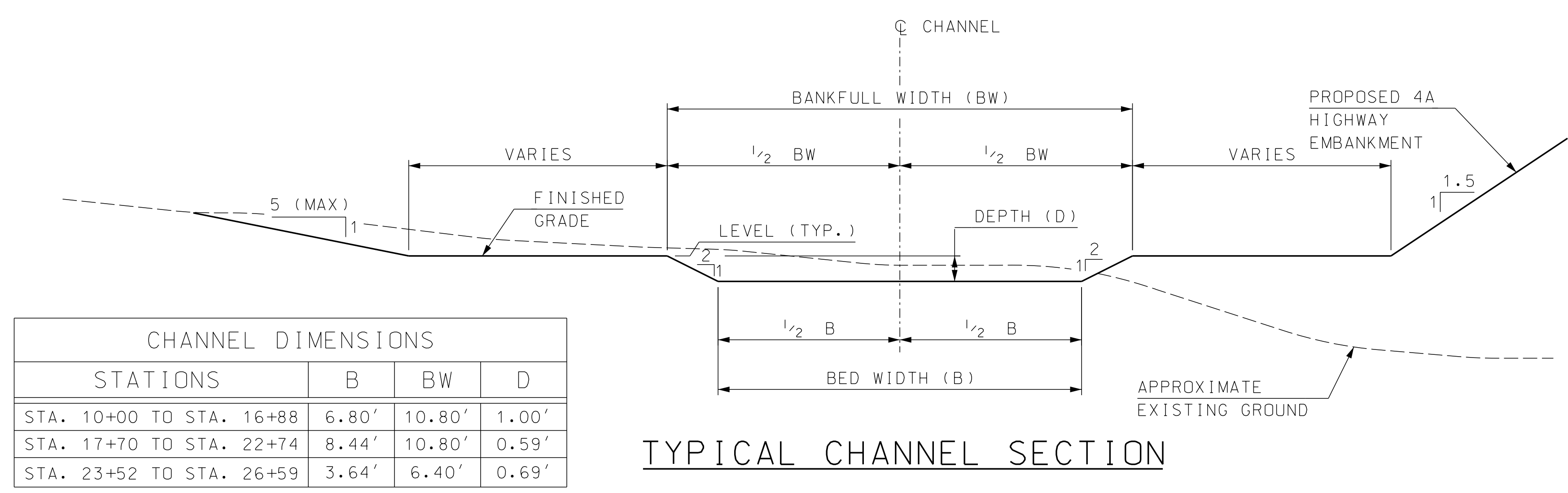

CHANNEL DIMENSIONS			
STATIONS	B	BW	D
STA. 10+00 TO STA. 16+88	6.80'	10.80'	1.00'
STA. 17+70 TO STA. 22+74	8.44'	10.80'	0.59'
STA. 23+52 TO STA. 26+59	3.64'	6.40'	0.69'

TYPICAL CHANNEL SECTION



STATE OF NEW HAMPSHIRE			
DEPARTMENT OF TRANSPORTATION • BUREAU OF HIGHWAY DESIGN			
TROLLEY CAR LANE STREAM PLANTING TABLE & SECTION			
DGN	STATE PROJECT NO.	SHEET NO.	TOTAL SHEETS
13065GRADE-NOTES	13065	2	6

SDR PROCESSED		DATE		DATE		DATE		DATE	
NEW DESIGN		LES/SRB		2/6/2020		2/6/2020		2/6/2020	
SHEET CHECKED		ETC/NCF							
AS BUILT DETAILS									

REVISIONS AFTER PROPOSAL	STATION	DESCRIPTION

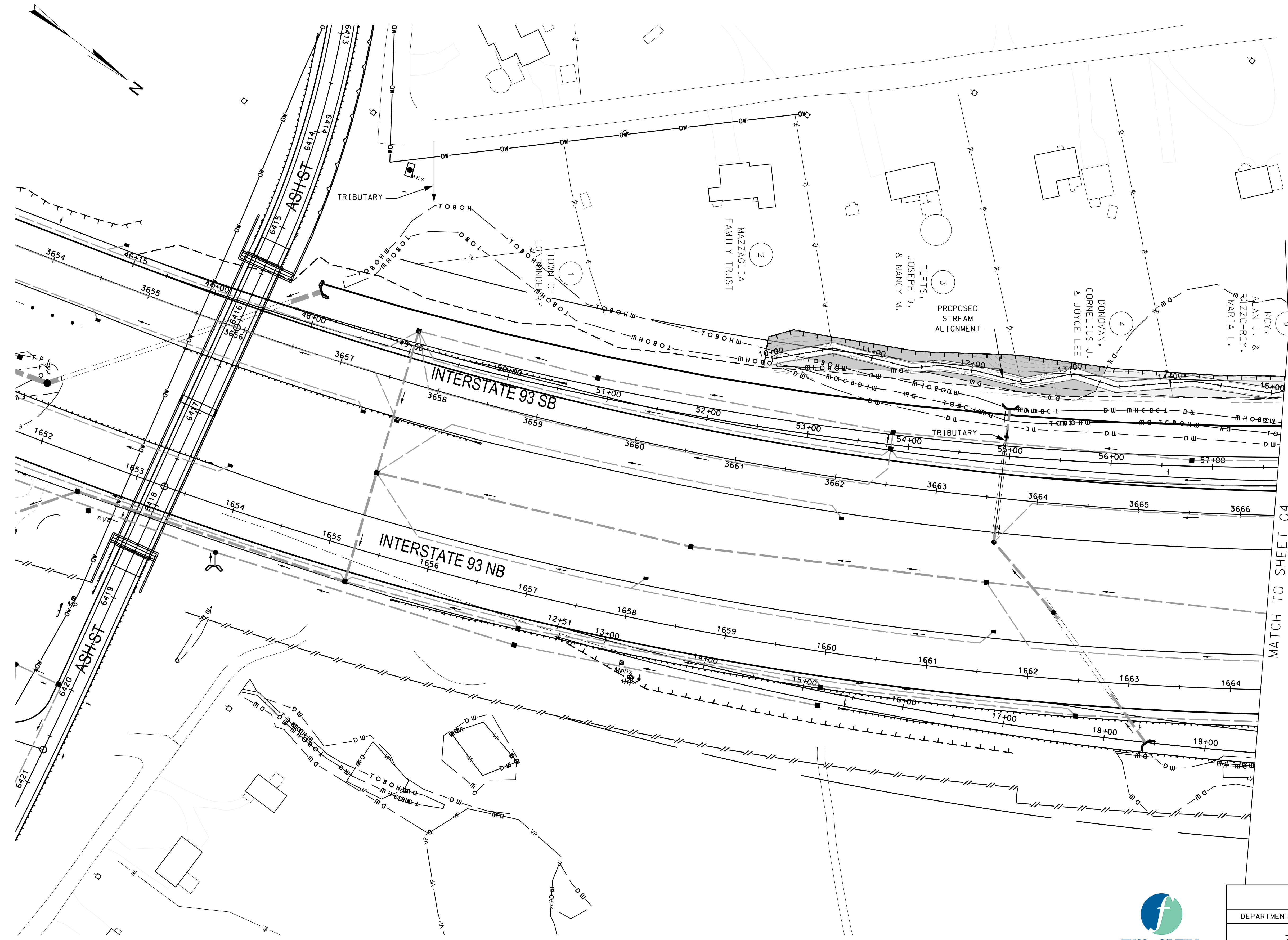

MATCH TO SHEET 04



LEGEND

	RESTORED WETLAND
	RESTORED UPLAND

CHANNEL GRADE CONTROL FEATURE LOCATIONS

STATION
22+75 TO 23+52
17+70 TO 20+82
11+64 TO 20+82
10+00 TO 10+50



STATE OF NEW HAMPSHIRE			
DEPARTMENT OF TRANSPORTATION • BUREAU OF HIGHWAY DESIGN			
TROLLEY CAR LANE STREAM GRADING PLAN			
DGN	STATE PROJECT NO.	SHEET NO.	TOTAL SHEETS
13065GRADE	13065	3	6

SDR PROCESSED	DATE	2/6/2020
NEW DESIGN	DATE	2/6/2020
SHEET CHECKED	DATE	2/6/2020
AS BUILT DETAILS	DATE	

REVISIONS AFTER PROPOSAL	DESCRIPTION	STATION
NUMBER	DATE	STATION

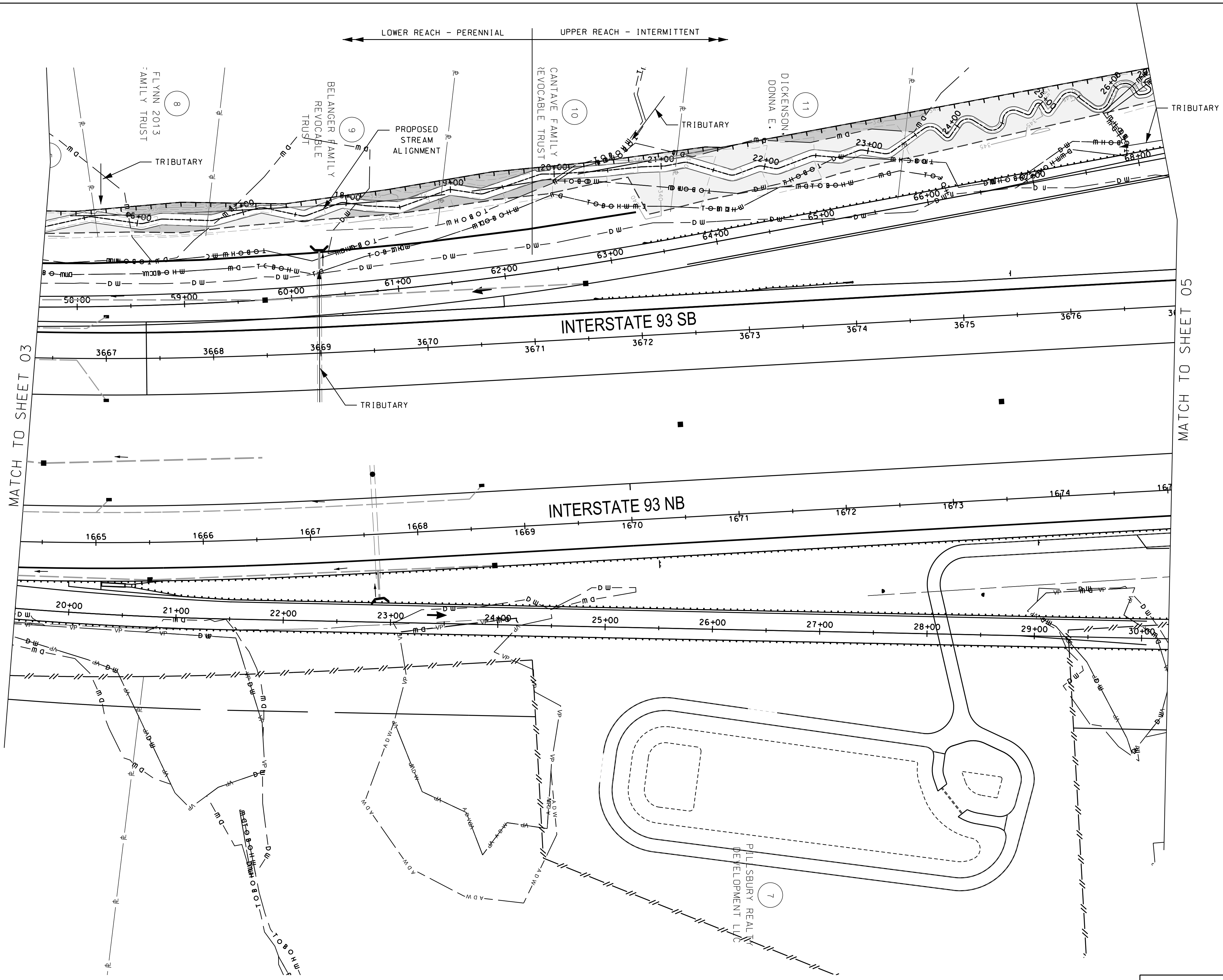
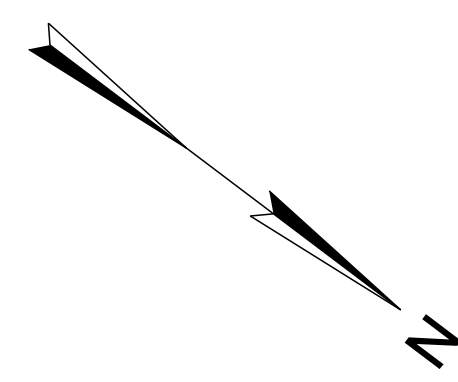

LEGEND

	RESTORED WETLAND
	RESTORED UPLAND

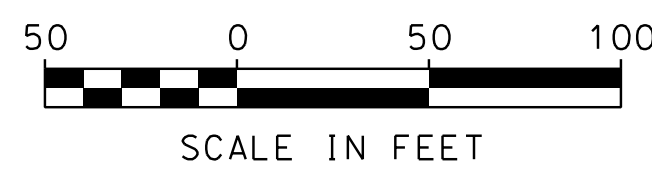

STATE OF NEW HAMPSHIRE			
DEPARTMENT OF TRANSPORTATION • BUREAU OF HIGHWAY DESIGN			
TROLLEY CAR LANE STREAM GRADING PLAN			
DGN	STATE PROJECT NO.	SHEET NO.	TOTAL SHEETS
13065GRADE	13065	4	6

SDR PROCESSED	DATE	2/6/2020
NEW DESIGN	LES/SRB	DATE
SHEET CHECKED	ETC/NCF	DATE
AS BUILT DETAILS	DATE	

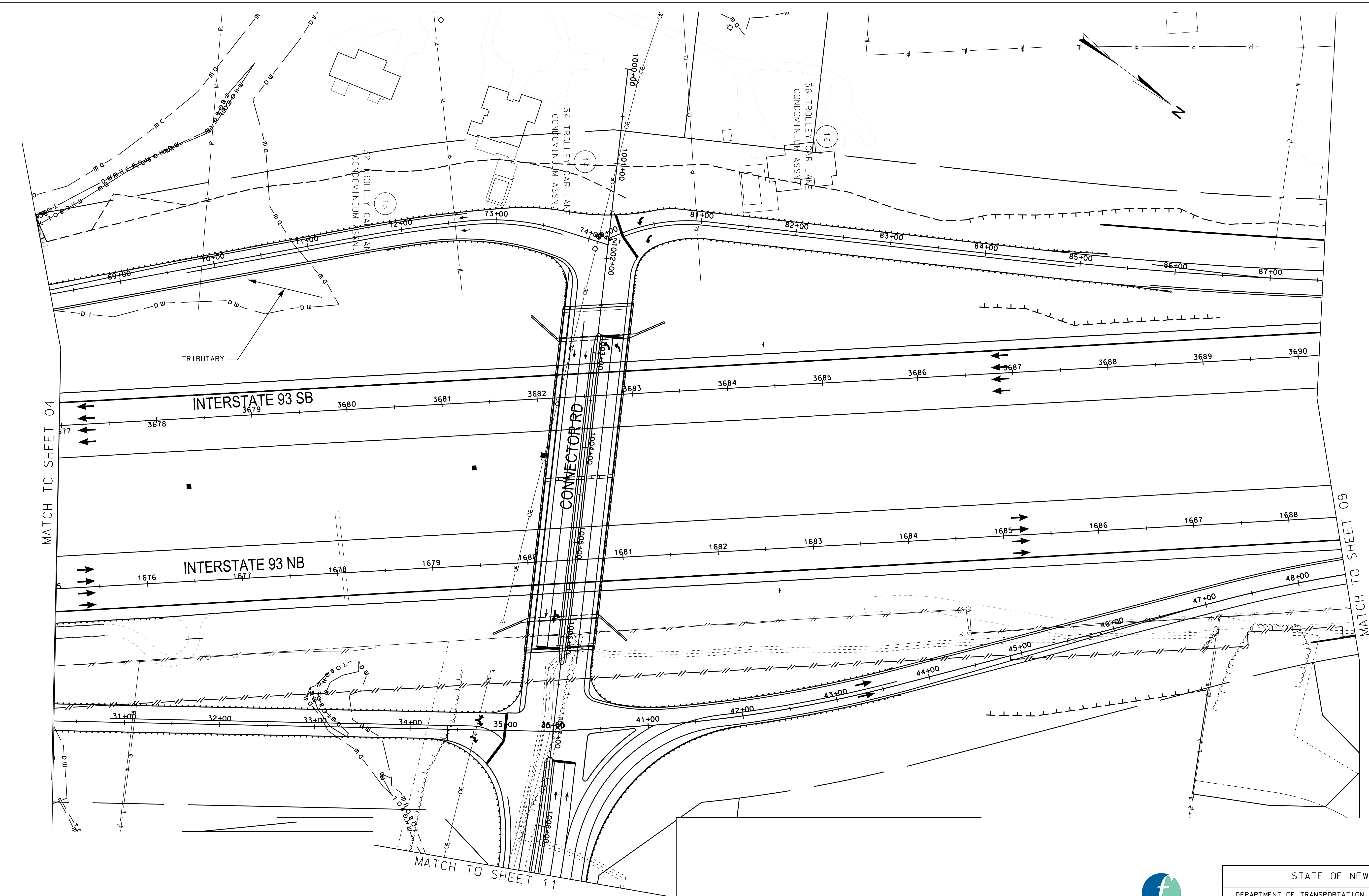

LEGEND

[Light Gray Box]	RESTORED WETLAND
[Dark Gray Box]	RESTORED UPLAND

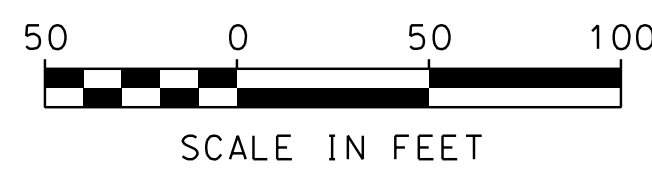

STATE OF NEW HAMPSHIRE			
DEPARTMENT OF TRANSPORTATION • BUREAU OF HIGHWAY DESIGN			
TROLLEY CAR LANE STREAM GRADING PLAN			
DGN	STATE PROJECT NO.	SHEET NO.	TOTAL SHEETS
13065GRADE	13065	5	6

SDR PROCESSED		DATE		REVISIONS AFTER PROPOSAL	
NEW DESIGN	LEC/SRB	DATE	4/28/2020	STATION	DESCRIPTION
SHEET CHECKED	ETC/NCF	DATE	4/28/2020	NUMBER	DATE
AS BUILT DETAILS		DATE			

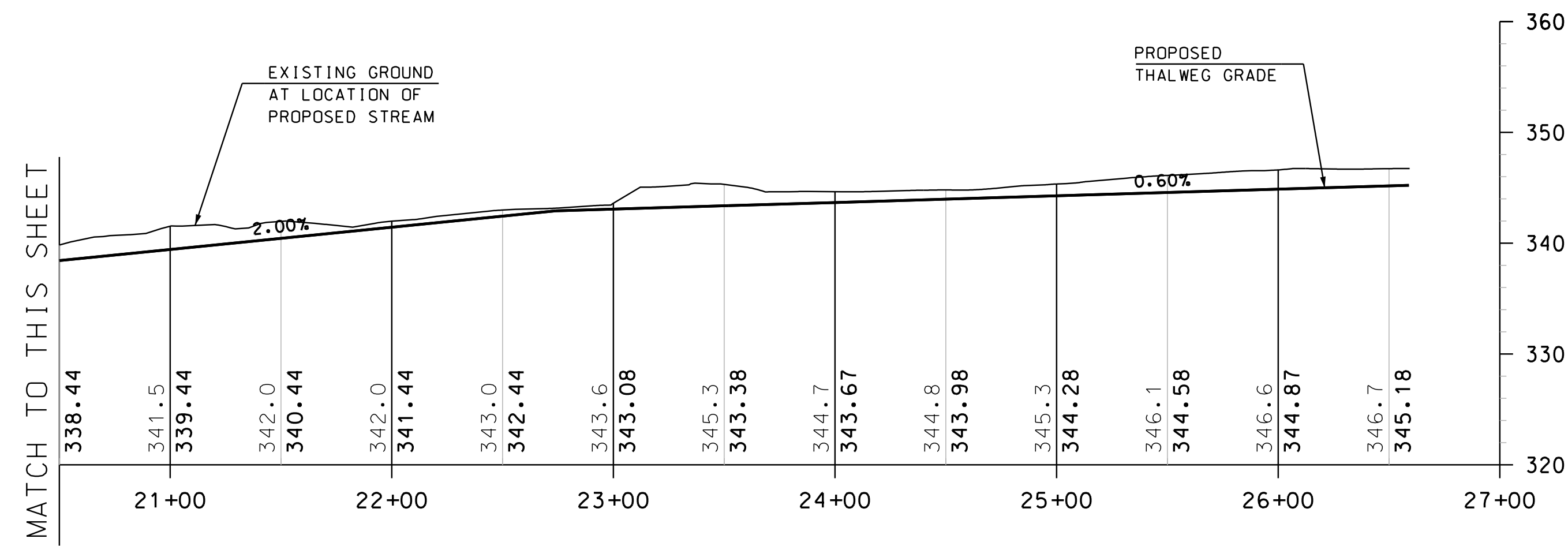
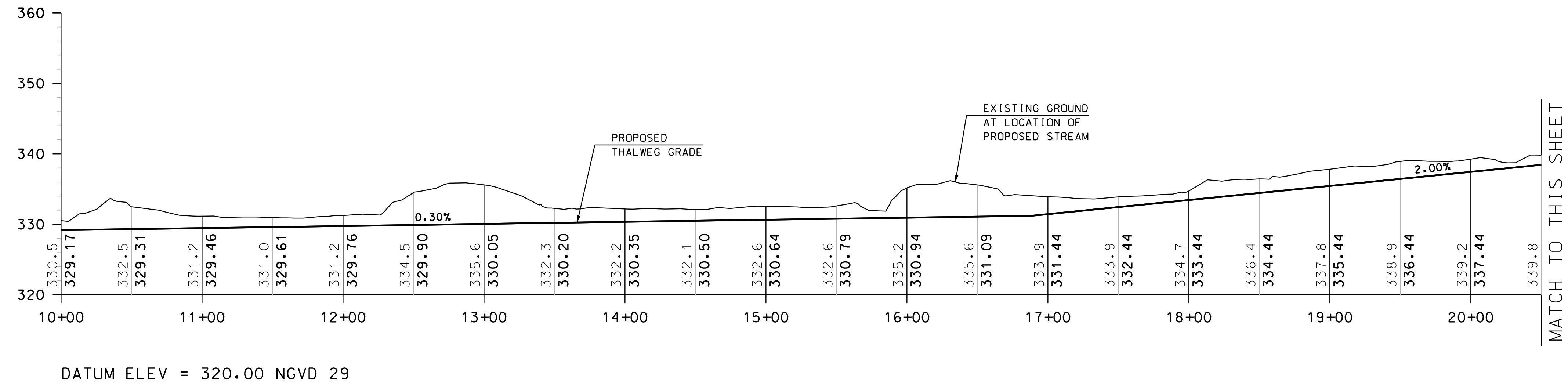

TROLLEY CAR LANE STREAM PROFILE

SCALE:
 1" = 50' HORIZ.
 1" = 10' VERT.

NOTE: THE EXISTING GROUND SHOWN IN THE PROFILE IS LOCATED AT THE LOCATION OF THE RELOCATED STREAM AND DOES NOT REFLECT THE EXISTING STREAM PROFILE



STATE OF NEW HAMPSHIRE			
DEPARTMENT OF TRANSPORTATION • BUREAU OF HIGHWAY DESIGN			
TROLLEY CAR LANE STREAM PROFILE			
DGN	STATE PROJECT NO.	SHEET NO.	TOTAL SHEETS
13065GRADE-PROF ILE	13065	6	6

INDEX OF SHEETS

- 1 FRONT SHEET
- 2-3 STANDARD SYMBOLS
- 4-5 WETLAND IMPACT TABLES
- 6-28 WETLAND IMPACT PLANS

STATE OF NEW HAMPSHIRE
DEPARTMENT OF TRANSPORTATION

WETLAND PLANS
I-93 EXIT 4A DERRY-LONDONDERRY
FEDERAL PROJECT IM-0931(201)
NH PROJECT 13065

13065

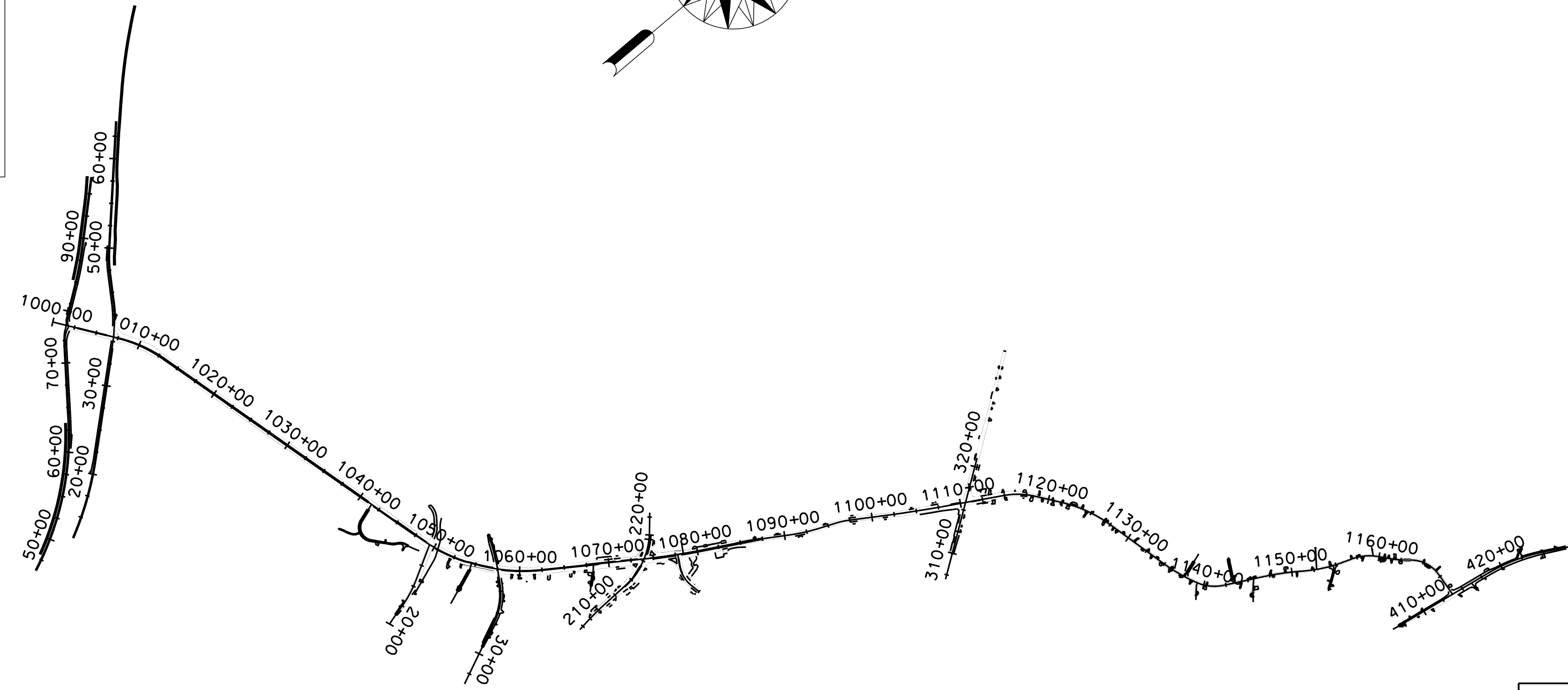
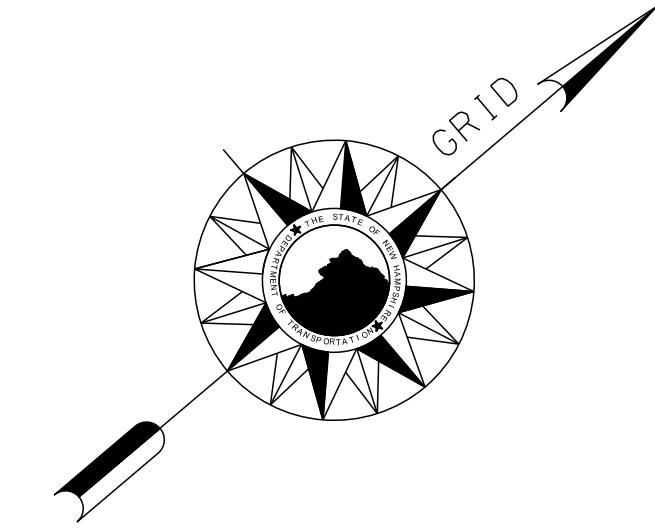
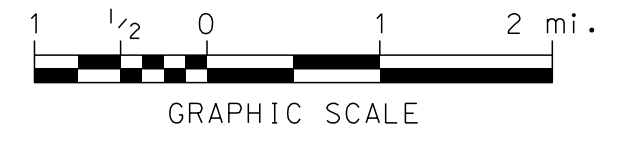
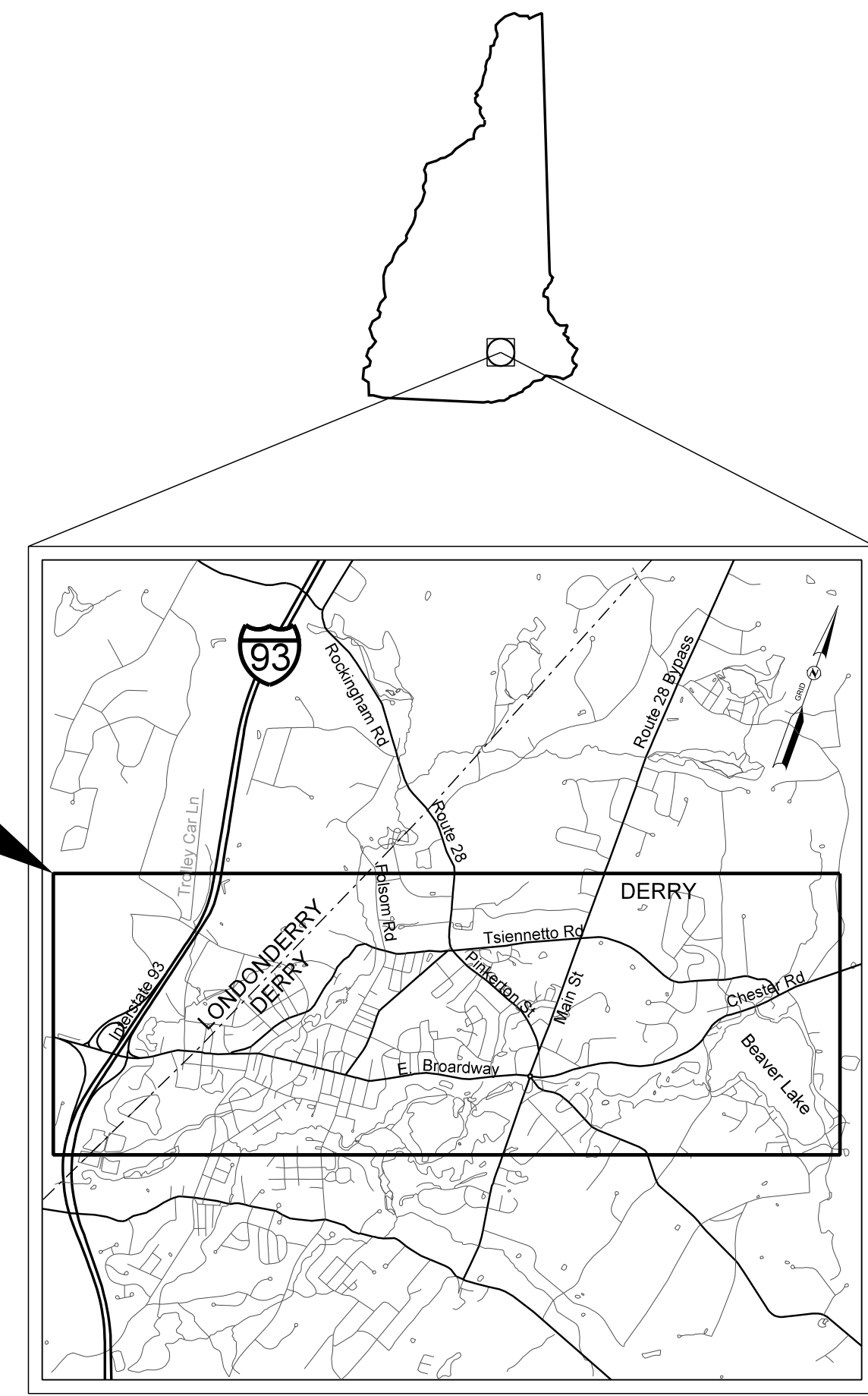

TOWNS OF LONDONDERRY & DERRY
COUNTY OF ROCKINGHAM
SCALE : 1" = 1000'
FOR CONSTRUCTION AND ALIGNMENT DETAILS -
SEE CONSTRUCTION PLANS

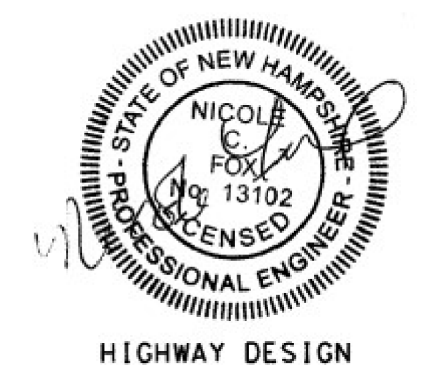
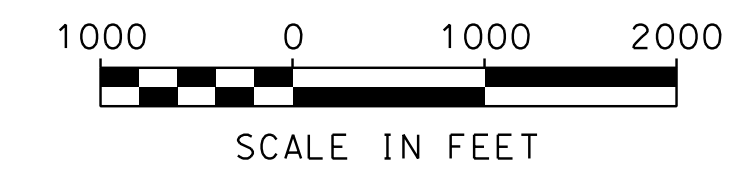

NH DOT THE STATE OF
NEW HAMPSHIRE
DEPARTMENT OF
TRANSPORTATION

RECOMMENDED FOR APPROVAL:

DIRECTOR OF PROJECT DEVELOPMENT DATE

APPROVED:

ASSISTANT COMMISSIONER AND CHIEF ENGINEER DATE

U. S. DEPARTMENT OF
TRANSPORTATION
FEDERAL HIGHWAY ADMINISTRATION

APPROVED:

DIVISION ADMINISTRATOR DATE

FEDERAL PROJECT NO.	STATE PROJECT NO.	SHEET NO.	TOTAL SHEETS
IM-0931(201)	13065	1	28

DATE 4/29/2020
DRAWN BY MGS
CHECKED BY NCF
DATE 4/29/2020

4/29/2020

GENERAL

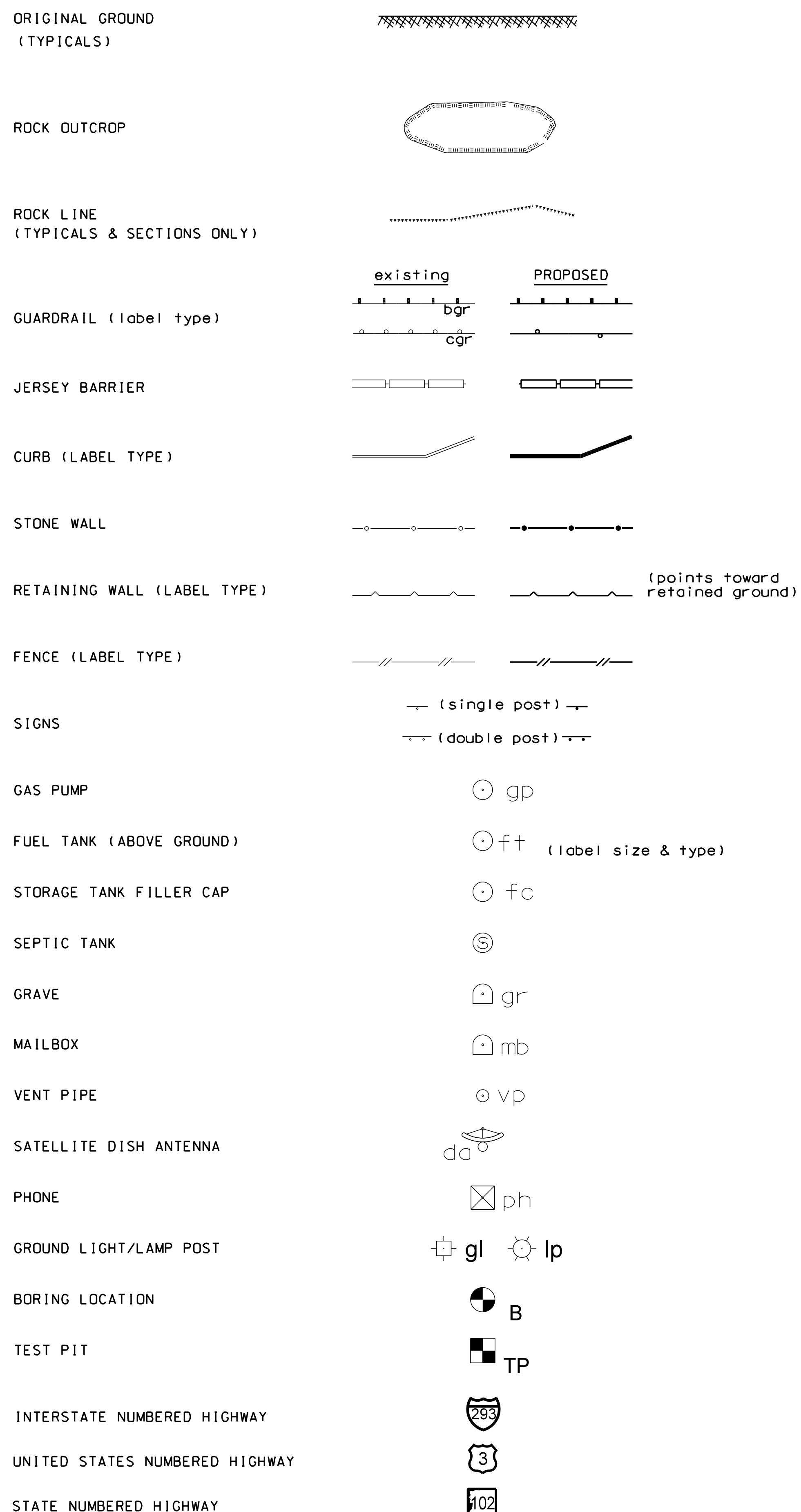
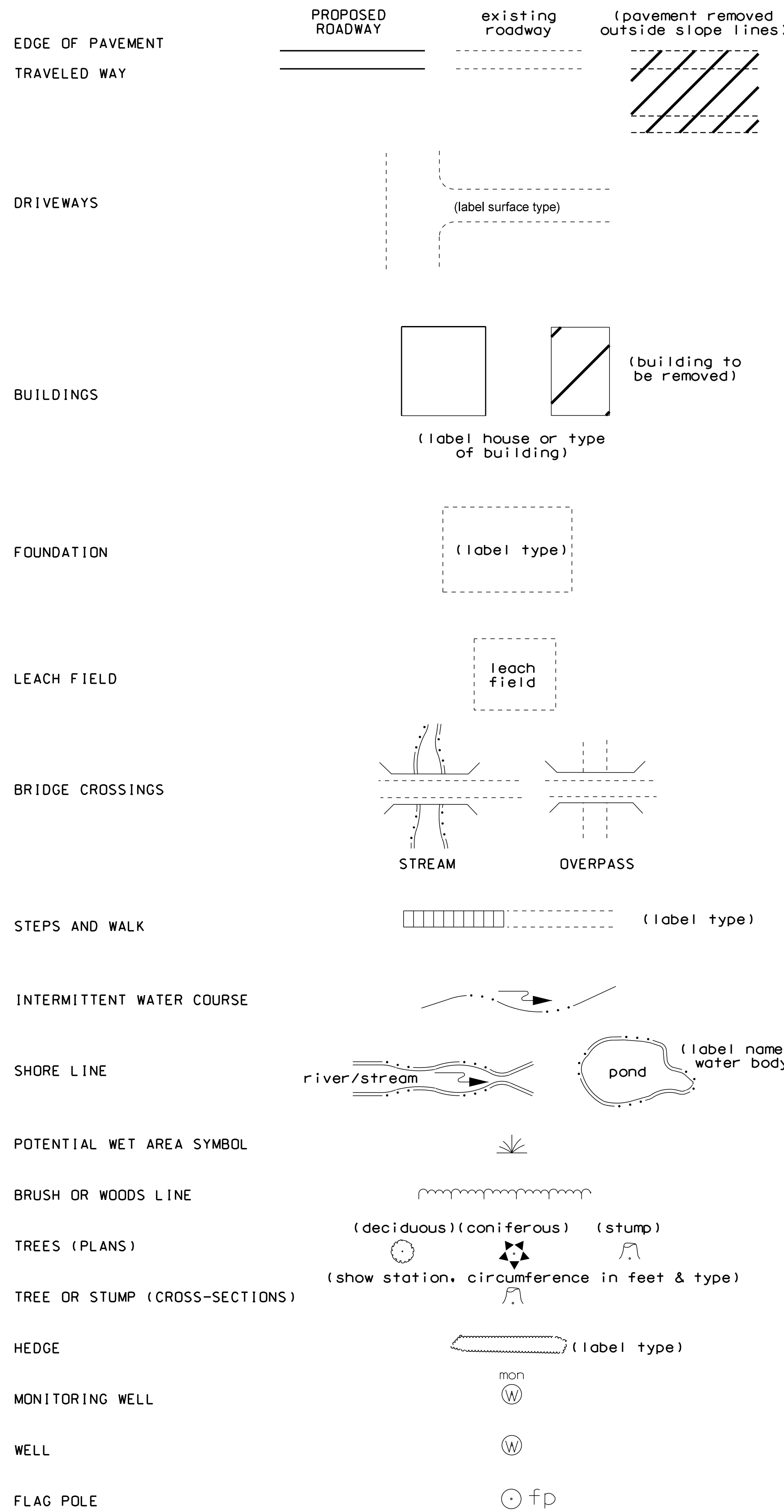

SHORELAND - WETLAND

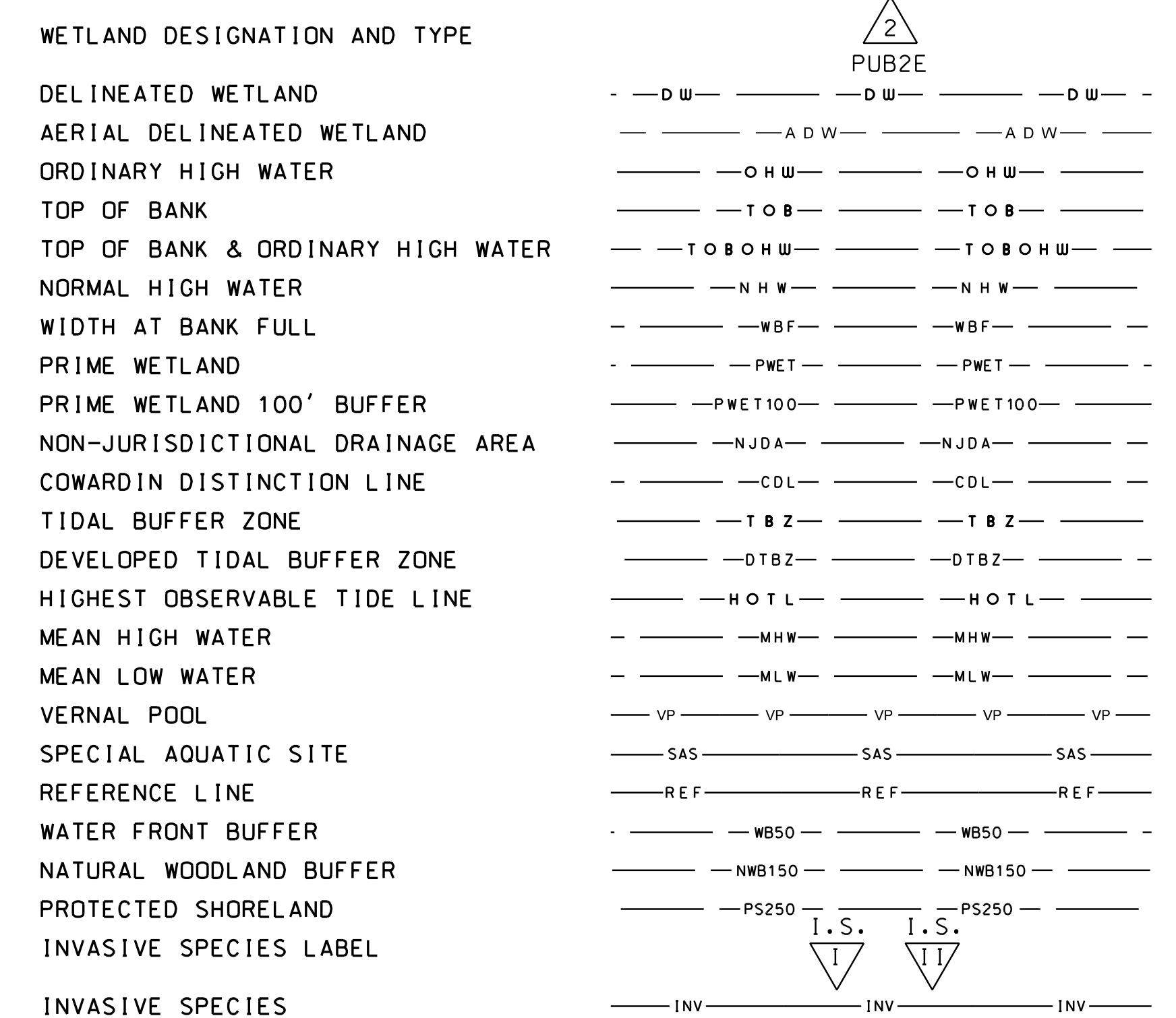

FLOODPLAIN / FLOODWAY

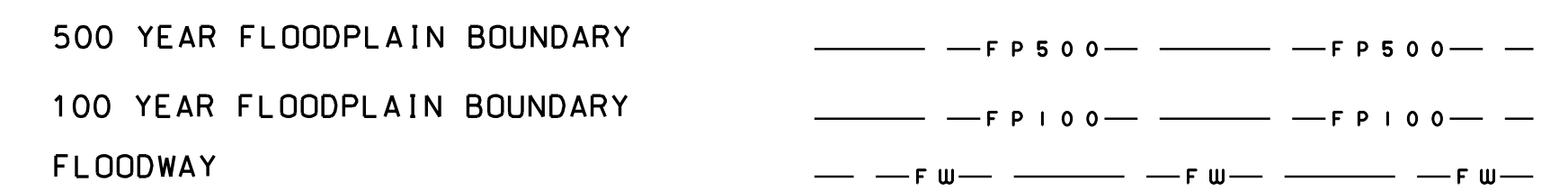

ENGINEERING

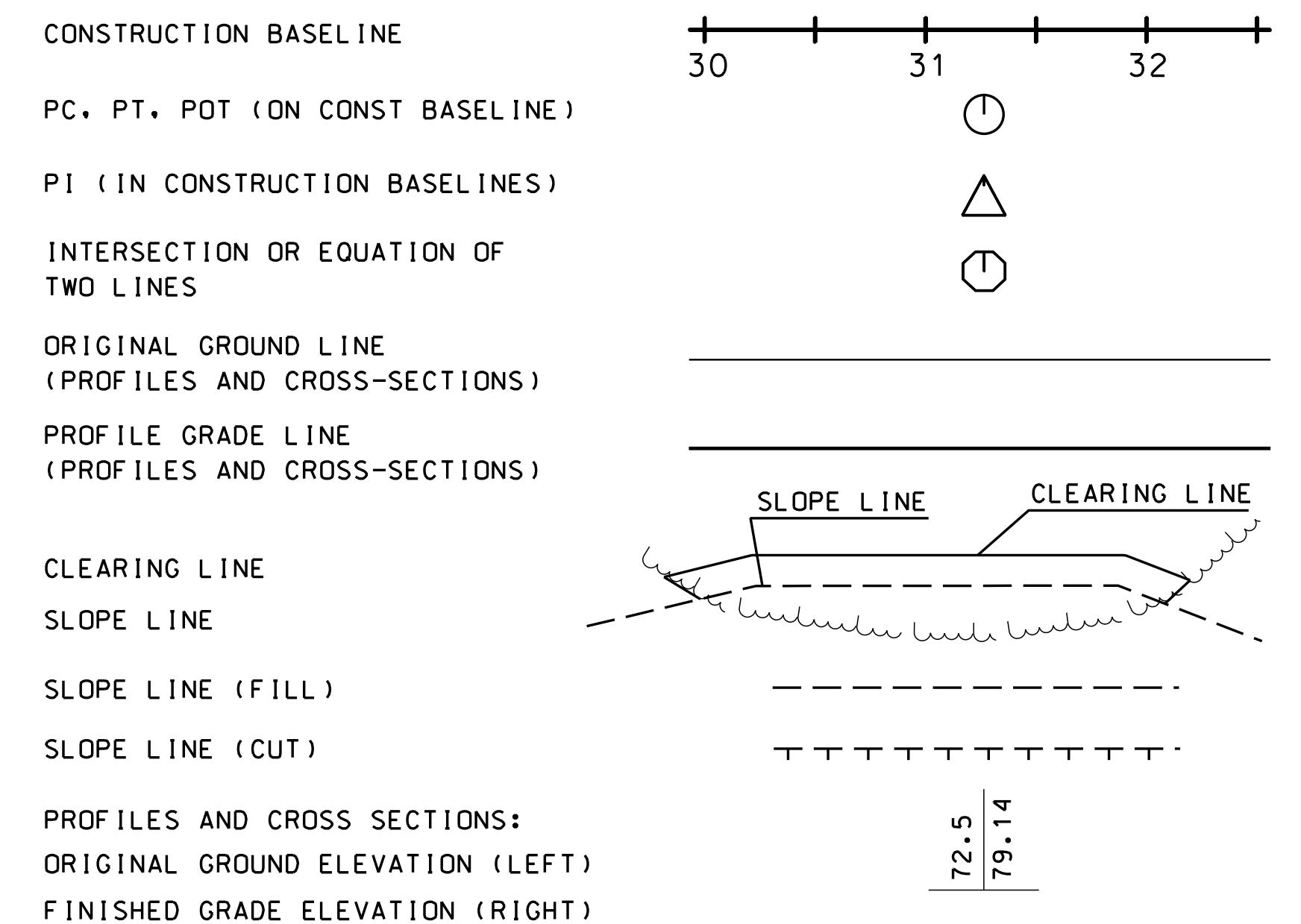

SHEET 1 OF 2

STATE OF NEW HAMPSHIRE
 DEPARTMENT OF TRANSPORTATION • BUREAU OF HIGHWAY DESIGN
STANDARD SYMBOLS

REVISION DATE	DGN	STATE PROJECT NO.	SHEET NO.	TOTAL SHEETS
11-21-2014	13065STDSYM	13065	2	28

DRAINAGE

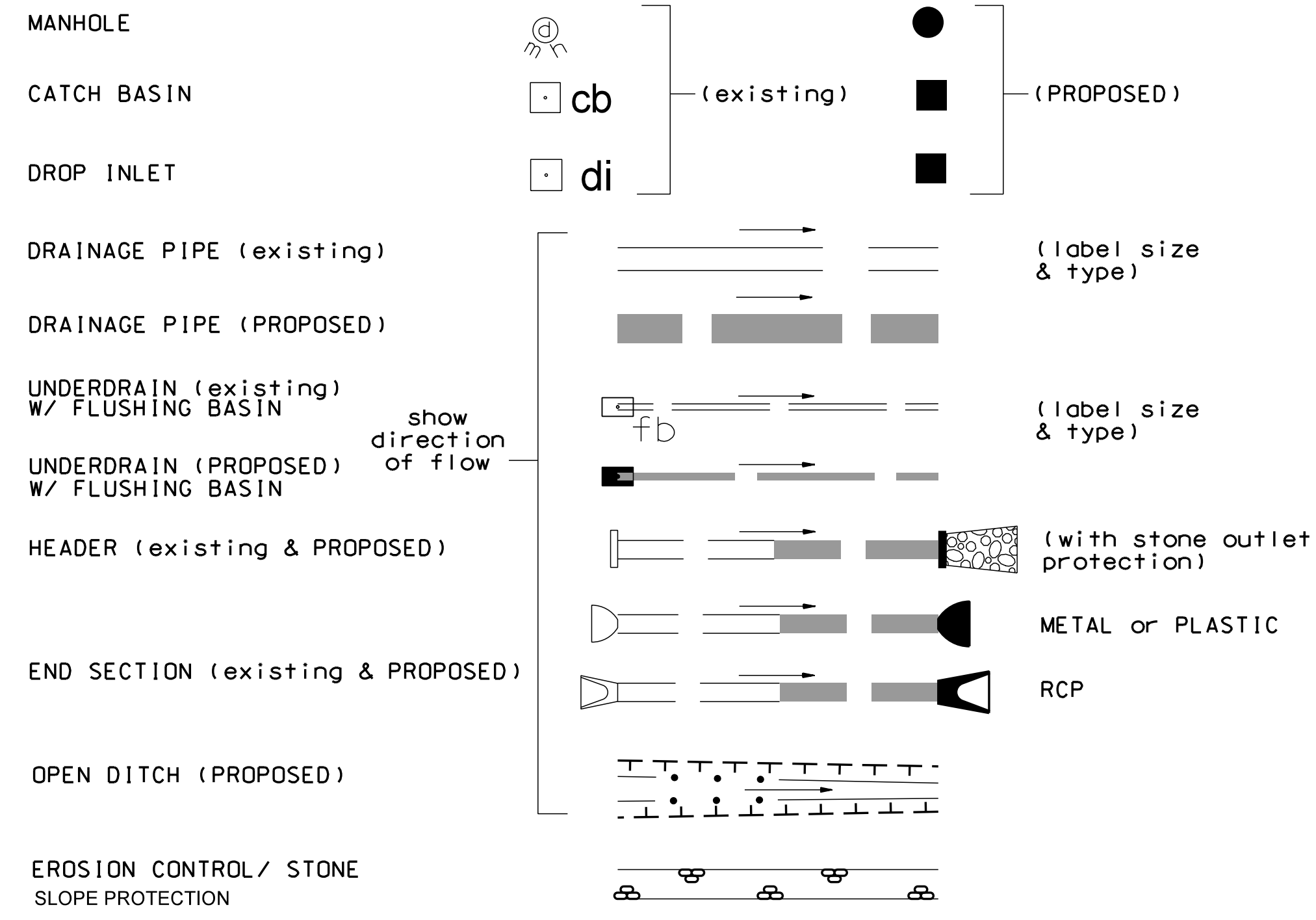

BOUNDARIES / RIGHT-OF-WAY

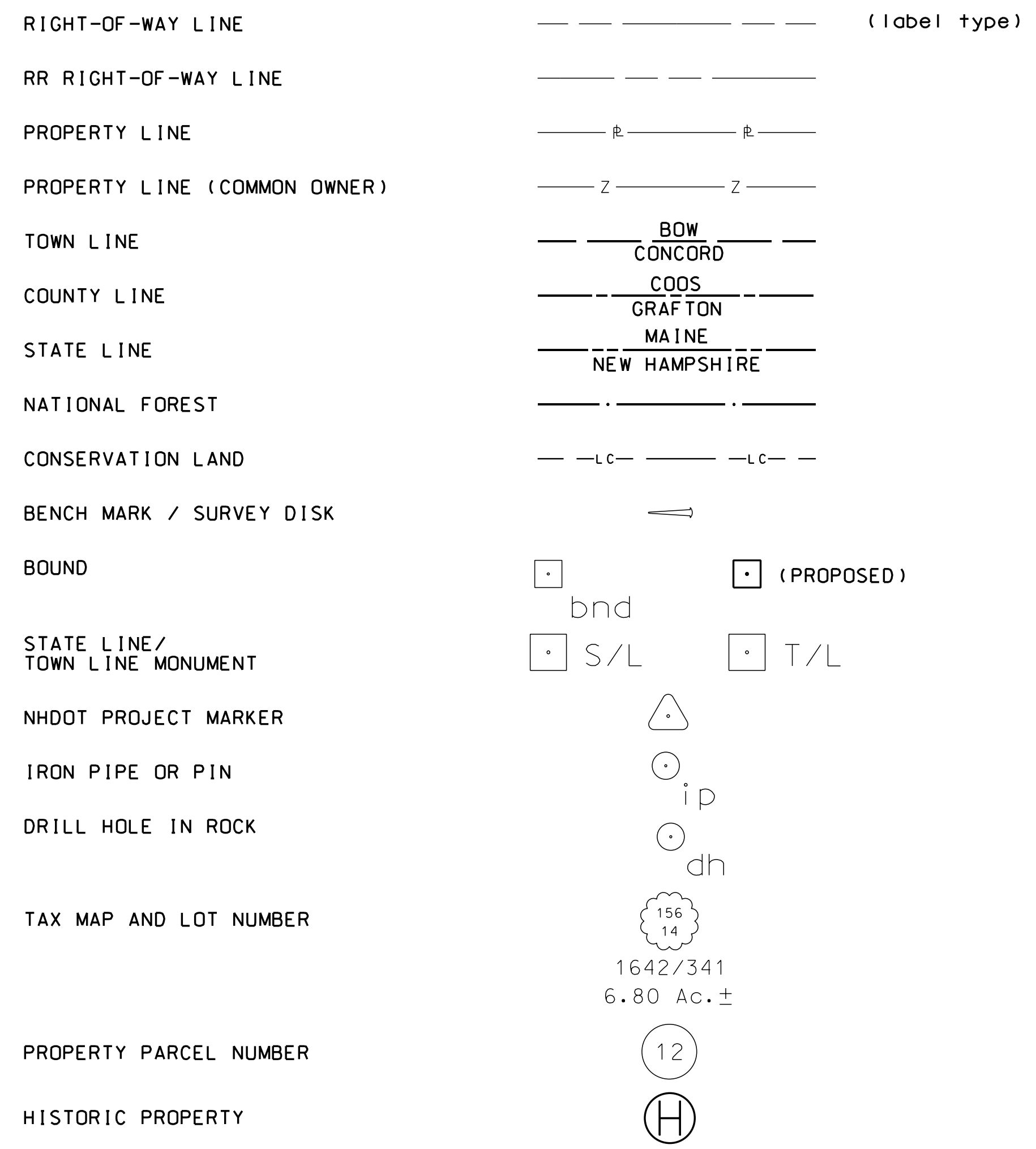

UTILITIES

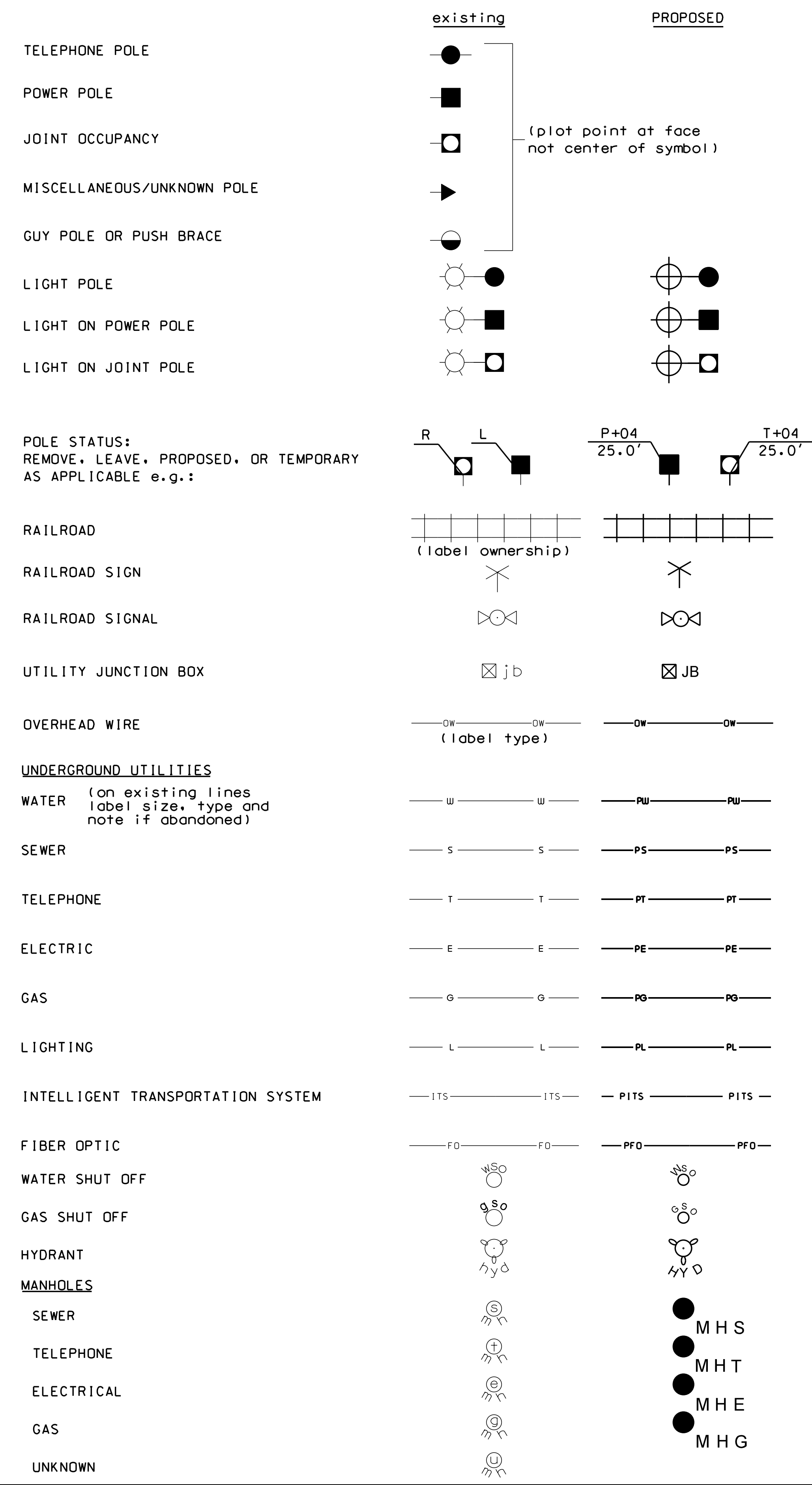

TRAFFIC SIGNALS / ITS

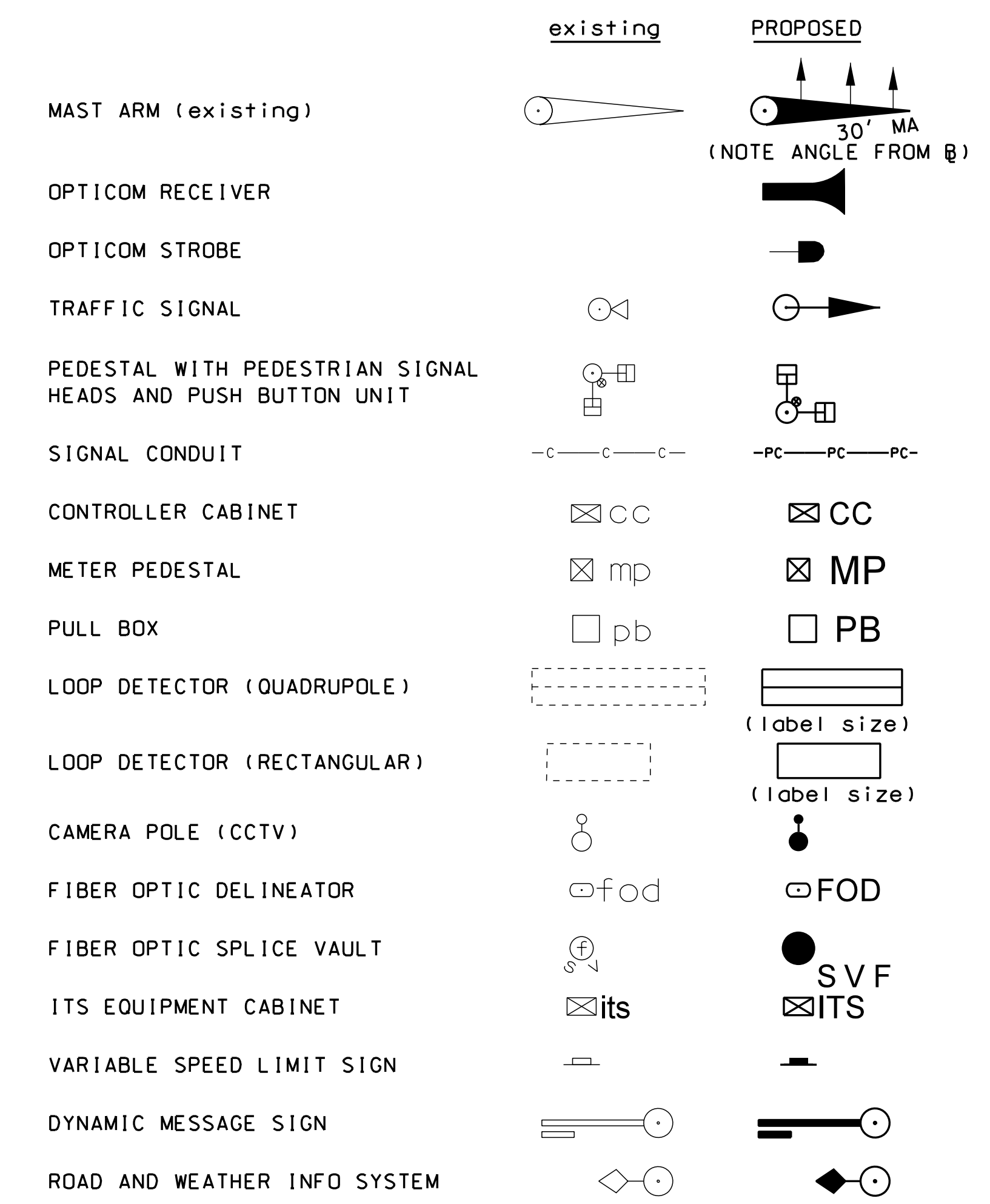

CONSTRUCTION NOTES

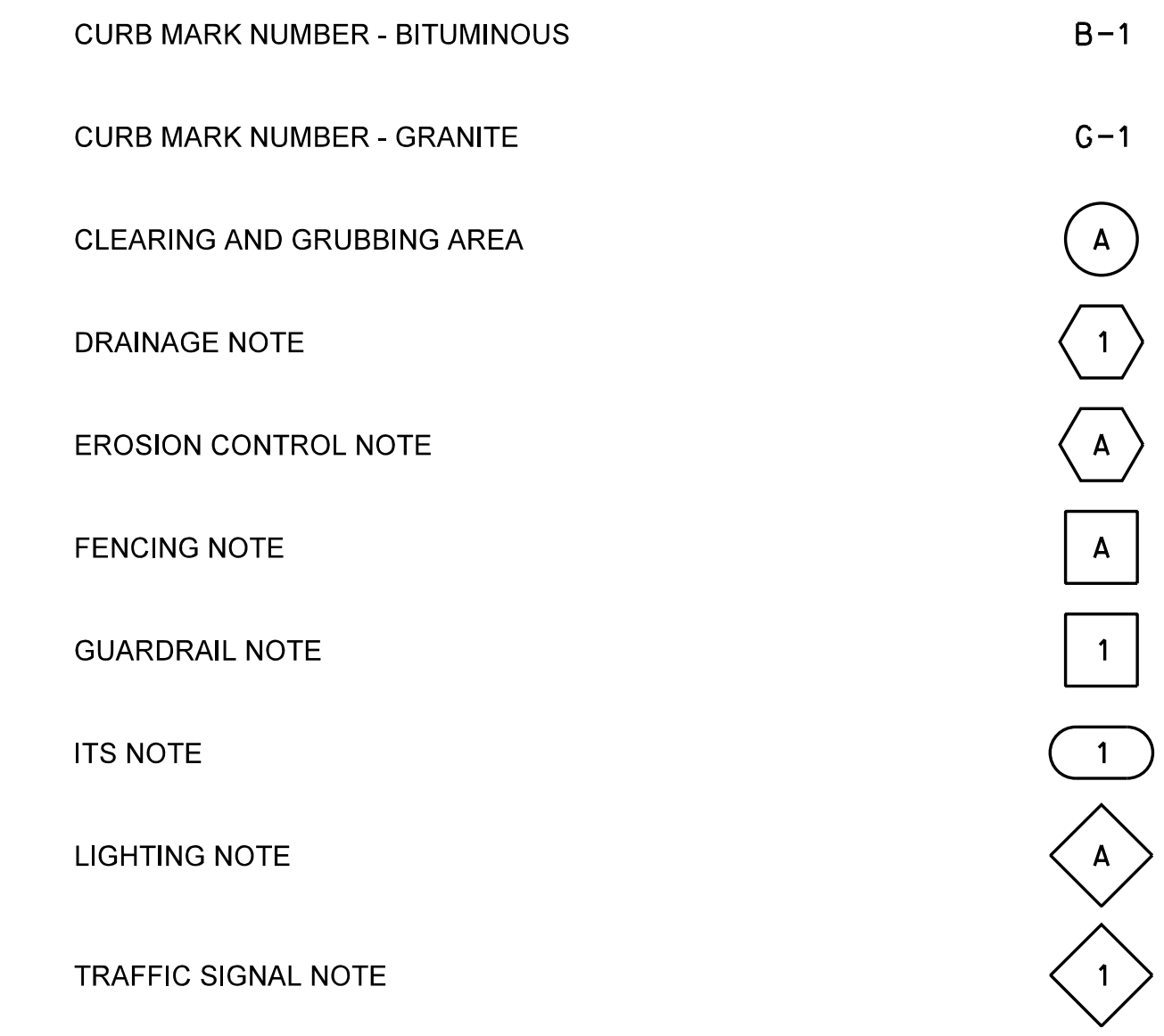

STATE OF NEW HAMPSHIRE				
DEPARTMENT OF TRANSPORTATION • BUREAU OF HIGHWAY DESIGN				
STANDARD SYMBOLS				
REVISION DATE	DGN	STATE PROJECT NO.	SHEET NO.	TOTAL SHEETS
9-1-2016	13065STDSYM	13065	3	28

SDR PROCESSED DATE 2/6/2020 EMM DATE 2/6/2020
 NEW DESIGN DATE 2/6/2020 NCF DATE 2/6/2020
 SHEET CHECKED DATE 2/6/2020
 AS BUILT DETAILS DATE

REVISIONS AFTER PROPOSAL
 STATION
 STATION
 DATE

WETLAND IMPACT SUMMARY								
WETLAND NUMBER	WETLAND CLASSIFICATION	LOCATION	PERMANENT	BANK	CHANNEL	TEMPORARY IMPACTS	TOWN	COMMENTS
			N.H.W.B. & A.C.O.E. (WETLAND)					
			SF	LF	LF	SF		
S1	R4UB3	A			44	336	L	self-mitigating
S1	R4UB3	B			1638	19364	L	self-mitigating
14	PFO1/2E	C	21575				L	
14	PFO1/2E	D	13598				L	
15	PFO1E	E	4382				L	
VP2	VP	F	7236				L	
14	PFO1/2E	G	6278				L	
15	PFO1E	H	1324				L	
16	PFO1E	I	2336				L	
VP3	VP	J	9387				L	
16	PFO1E	K	507				L	
S70	R4SB5	L	187		70		L	
14	PFO1/2E	M	16866				L	
14	PFO1/2E	N	37008				L	
16	PFO1E	O	199				L	
VP4	VP	P	9278				L	
16	PFO1E	Q	2061				L	
16	PFO1E	R	1919				L	
S9	R4SB5	S	48		23		L	
17	PFO1E	T	39				L	
S7	R4SB5	U	884		117		L	
17	PFO1E	V	3484				L	
S7	R4SB5	W	738		116		L	
13	PFO1E	X	1820				L	
66	PFO1E	Y	692				L	
11	PFO1E	Z	909				L	
11	PFO1E	AA	3312				L	
67	PFO1E	AB	1483				L	
11	PFO1E	AC	366				L	
11	PFO1E	AD	2519				L	
19	PFO1E	AE	9131				L	
VP42	VP	AF	5415				L	
18	PEM1E	AG	659				L	
S8	R4SB5	AH	1232		291		L	
20	PFO1E	AI	273				L	
20	PFO1E	AJ	1232				L	
21	PFO1E	AK	361				L	
VP46	VP	AL	611				L	
22	PFO1E	AM	216				L	
24	PFO1E	AN	167				L	
VP6	VP	AO	15631				L	
24	PFO1E	AP	5				L	
24	PFO1E	AQ	452				L	
24	PFO1E	AR	98				L	
24	PFO1E	AS	2598				L	
24	PFO1E	AT	168				L	
90	PFO1E	AU	1148				L	
35	PFO1E	AV	136				L	
35	PFO1E	AW	1155				L	
VP8	VP	AX	10722				L	
35	PFO1E	AY	21				L	
35	PFO1E	AZ	301				L	
35	PFO1E	BA	5				L	
35	PFO1E	BB	526				L	
VP9	VP	BC	3335				L/D	
64	PFO1E	BD	180				L/D	
64	PFO1E	BE	382				L/D	
64	PFO1E	BF	1139				L/D	
39	PEM1F	BG	4379				D	
S11	R4SB5	BH	77		77		D	
40	PSS1E	BI	852				D	

WETLAND IMPACT SUMMARY								
WETLAND NUMBER	WETLAND CLASSIFICATION	LOCATION	PERMANENT	BANK	CHANNEL	TEMPORARY IMPACTS	TOWN	COMMENTS
			N.H.W.B. & A.C.O.E. (WETLAND)					
			SF	LF	LF	SF		
86	PFO1E	BJ	552				D	
72	PSS1/PEM1/PFO1B	BK	155				D	Prime Wetland
S2	R3UB3	BL	4048	404	202		D	
41	PFO1E	BM	176				D	
41	PFO1E	BN	6901				D	
S2	R3UB3	BO	780	107	45		D	
46	PFO1E	BP	2561				D	
73	PEM1/PSS1E	BQ	2850				D	
49	PFO1E	BR	3025				D	
100	PFO1E	BS	311				D	
102	PEM1E	BT	90				D	
S101	R4SB2	BU	54		13		D	
61	PFO1E	BV	582				D	
81	PFO	BW	273				D	
54	PEM1E	BX	62				D	
S3	R4SB5	BY	159		24		D	
S3	R4SB5	BZ	265		33		D	
S4	R4SB5	CA	219		46		D	
S4	R4SB5	CB	196		29		D	
80	PFO1E/PEM1E	CC	941				D	
80	PFO1E/PEM1E	CD	81				D	
80	PFO1E/PEM1E	CE	215				D	
80	PFO1E/PEM1E	CF	598				D	
80	PFO1E/PEM1E	CG	40				D	
S100	R4SB6	CH	125		22		D	
59	PFO1E	CI	815				D	
56	PEM1E	CJ	615				D	
62	PSS/PEM1E	CK	1389				D	Prime Wetland
59	PFO1E	CL	1666				D	
62	PSS/PEM1E	CM	172				D	Prime Wetland
S5	R3UB3	CN	109	32	11		D	
62	PSS/PEM1E	CO	410				D	Prime Wetland
S102	R4SB2	CP	212		41		D	
19	PFO1E	CQ	497				L	
S1	R4UB3	CR			37	694	L	self-mitigating
S1	R4UB3	TA			5	42	L	
S1	R4UB3	TB			5	150	L	
14	PFO1/2E	TC				1261	L	
15	PFO1E	TD				290	L	
15	PFO1E	TE				145	L	
VP2	VP	TF				606	L	
15	PFO1E	TG				50	L	
14	PFO1/2E	TH				593	L	
VP3	VP	TI				810	L	
14	PFO1/2E	TJ				1239	L	
14	PFO1/2E	TK				1072	L	
S1	R4UB3	TL			5	68	L	
14	PFO1/2E	TM				1267	L	
S9	R4SB5	TN			5	16	L	
66	PFO1E	TO				271	L	
11	PFO1E	TP				457	L	
11	PFO1E	TQ				703	L	
67	PFO1E	TR				691	L	
9	PFO1	TS				77	L	
9	PFO1	TT				52	L	
11	PFO1E	TU				1206	L	
21	PFO1E	TZ				177	L	
VP46	VP	TAA				68	L	
22	PFO1E	TAB				38	L	
VP6	VP	TAC				126	L	

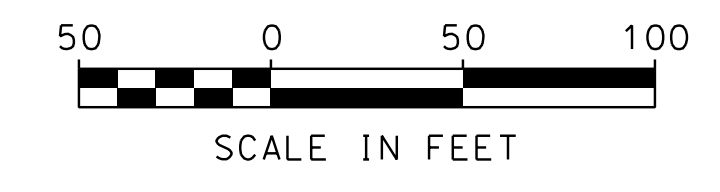

STATE OF NEW HAMPSHIRE			
DEPARTMENT OF TRANSPORTATION • BUREAU OF HIGHWAY DESIGN			
WETLAND IMPACT TABLES			
DGN	STATE PROJECT NO.	SHEET NO.	TOTAL SHEETS
13065 TABLE	13065	4	28

SDR PROCESSED
 NEW DESIGN EMM
 SHEET CHECKED NCF
 AS BUILT DETAILS

REVISIONS AFTER PROPOSAL

STATION

STATION

DATE

NUMBER

DATE 2/6/2020

DATE 2/6/2020

DATE

WETLAND IMPACT SUMMARY								
WETLAND NUMBER	WETLAND CLASSIFICATION	LOCATION	PERMANENT N.H.W.B. & A.C.O.E. (WETLAND)	BANK	CHANNEL	TEMPORARY IMPACTS	TOWN	COMMENTS
			SF	LF	LF	SF		
24	PFO1E	TAD				79	L	
24	PFO1E	TAE				32	L	
VP6	VP	TAF				378	L	
24	PFO1E	TAG				7	L	
90	PFO1E	TAH				105	L	
35	PFO1E	TAI				76	L	
VP8	VP	TAJ				15	L	
VP8	VP	TAK				611	L	
35	PFO1E	TAL				90	L	
35	PFO1E	TAM				7	L	
VP8	VP	TAN				619	L	
35	PFO1E	TAO				38	L	
39	PEM1F	TAP				356	D	
S2	R3UB3	TAQ		32	20	129	D	
72	PSS1/PEM1/PFO1B	TAR				100	D	Prime Wetland
S2	R3UB3	TAS		10	5	85	D	
41	PFO1E	TAT				150	D	
S2	R3UB3	TAU		10	5	154	D	
41	PFO1E	TAV				160	D	
S2	R3UB3	TAW		10	5	77	D	
S2	R3UB3	TAX		10	5	87	D	
85	PSS1E	TAY				63	D	
46	PFO1E	TAZ				646	D	
73	PEM1/PSS1E	TBA				1281	D	
83	PEM1E	TBB				100	D	
49	PFO1E	TBC				459	D	
102	PEM1E	TBD				53	D	
60	PFO1E	TBE				54	D	
81	PEM1H/PUB5H	TBF				144	D	
81	PEM1H/PUB5H	TBG				260	D	
54	PEM1E	TBH				162	D	
103	PFO1	TBI				9	D	
S3	R4SB5	TBJ			5	19	D	
S3	R4SB5	TBK			5	34	D	
S4	R4SB5	TBL			5	33	D	
S4	R4SB5	TBM			5	15	D	
80	PFO1E/PEM1E	TBN				420	D	
80	PFO1E/PEM1E	TBO				561	D	
80	PFO1E/PEM1E	TBP				213	D	
80	PFO1E/PEM1E	TBQ				130	D	
80	PFO1E/PEM1E	TBR				52	D	
59	PFO1E	TBS				176	D	
56	PEM1E	TBT				112	D	
62	PSS/PEM1E	TBU				1228	D	Prime Wetland
59	PFO1E	TBV				92	D	
59	PFO1E	TBW				94	D	
S5	R3UB3	TBX		25	5	135	D	
59	PFO1E	TBY				482	D	
S5	R3UB3	TBZ		18	8	22	D	
62	PSS/PEM1E	TCA				73	D	Prime Wetland
62	PSS/PEM1E	TCB				159	D	Prime Wetland
54	PEM1E	TCC				27	D	
VP11	VP	TCD				87	D	
S1	R4UB3	TCE			5	114	L	
S1	R4UB3	TCF			121	370	L	

WETLAND CLASSIFICATION CODES	
BANK	BANK
PEM1E	PALUSTRINE, EMERGENT, PERSISTENT, SEASONALLY FLOODED /SATURATED
PEM1F	PALUSTRINE, EMERGENT, PERSISTENT, SEMIPERMANENTLY FLOODED
PEM1H/PUB5H	PERMANENTLY FLOODED PALUSTRINE EMERGENT, PERSISTENT WETLAND, MIXED WITH OPEN WATER, UNCONSOLIDATED BOTTOM
PFO1/2E	PALUSTRINE, FORESTED, DOMINANTLY BROAD-LEAVED DECIDUOUS, MIXED WITH NEEDLE-LEAVED DECIDUOUS, SEASONALLY FLOODED /SATURATED
PFO1E	PALUSTRINE, FORESTED, BROAD-LEAVED DECIDUOUS, SEASONALLY FLOODED /SATURATED
PFO1E/PEM1E	PALUSTRINE, FORESTED, BROAD-LEAVED DECIDUOUS WETLAND MIXED WITH SEASONALLY SATURATED EMERGENT PERSISTENT WETLAND
PSS/PEM1E	PALUSTRINE, DOMINANTLY SCRUB-SHRUB, MIXED WITH EMERGENT, PERSISTENT, SEASONALLY FLOODED /SATURATED
PSS1E	PALUSTRINE, SCRUB-SHRUB, BROAD-LEAVED DECIDUOUS, SEASONALLY FLOODED /SATURATED
R3UB3	RIVERINE, UPPER PERENNIAL, UNCONSOLIDATED BOTTOM, MUD
R4UB3	RIVERINE, INTERMITTENT, UNCONSOLIDATED BOTTOM, MUD
R4SB	RIVERINE, INTERMITTENT, STREAMBED
R4SB5	RIVERINE, INTERMITTENT, STREAMBED, MUD
VP	VERNAL POOL

TOTAL IMPACTS FOR WETLANDS	
WETLAND AND STREAM IMPACTS (AREA)	
PERMANENT IMPACTS (WETLAND)	234,853.00 SF
PERMANENT IMPACTS (STREAM)	9,333.00 SF
TEMPORARY IMPACTS	43,103.00 SF
TOTAL WETLAND IMPACTS:	287,289.00 SF
STREAM IMPACTS (LINEAR)	
PERMANENT IMPACTS TO BANKS	543.00 LF
PERMANENT IMPACTS TO CHANNEL	1,160.00 LF
TEMPORARY IMPACTS TO BANKS	115.00 LF
TEMPORARY IMPACTS TO CHANNEL	1,938.00 LF
TOTAL STREAM IMPACTS:	3,756.00 LF



STATE OF NEW HAMPSHIRE			
DEPARTMENT OF TRANSPORTATION • BUREAU OF HIGHWAY DESIGN			
WETLAND IMPACT TABLES			
DGN	STATE PROJECT NO.	SHEET NO.	TOTAL SHEETS
13065 TABLE	13065	5	28

SDR PROCESSED	DATE	2/6/2020
NEW DESIGN	DATE	2/6/2020
SHEET CHECKED	DATE	2/6/2020
AS BUILT DETAILS	DATE	

REVISIONS AFTER PROPOSAL	STATION	DESCRIPTION

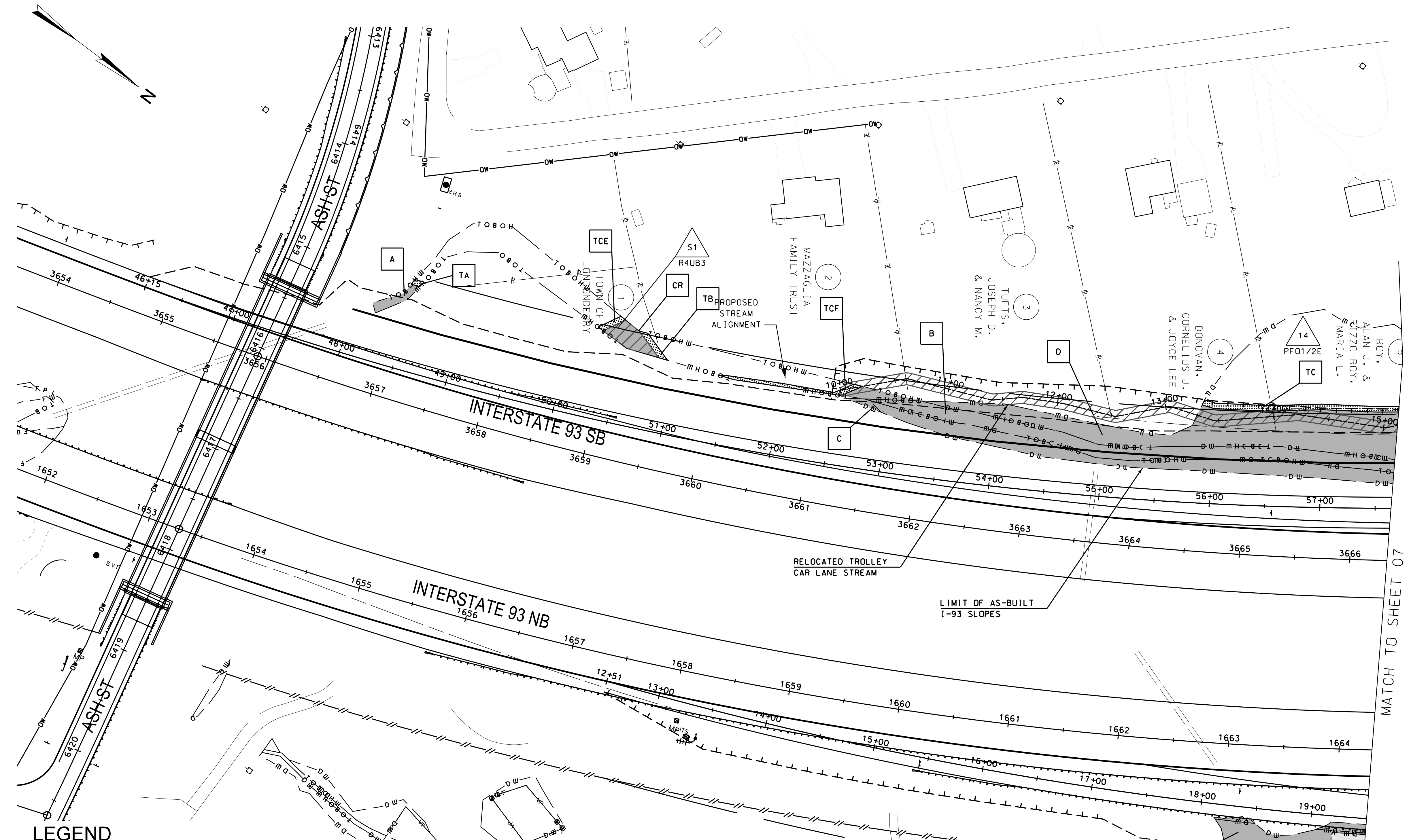

LEGEND

TYPE OF WETLAND IMPACT	SHADING/HATCHING
WETLANDS - NEW HAMPSHIRE WETLANDS BUREAU & ARMY CORP OF ENGINEERS (PERMANENT WETLAND)	
VERNAL POOL - NEW HAMPSHIRE WETLANDS BUREAU & ARMY CORP OF ENGINEERS (PERMANENT WETLAND)	
NEW HAMPSHIRE WETLANDS BUREAU & ARMY CORP OF ENGINEERS (TEMPORARY WETLAND)	
RELOCATED STREAM SELF MITIGATING	

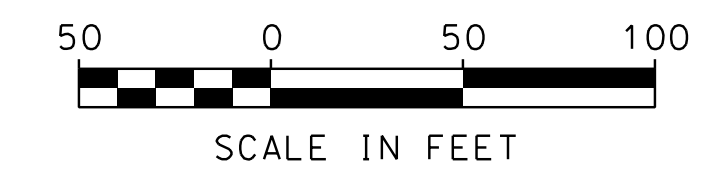

STATE OF NEW HAMPSHIRE			
DEPARTMENT OF TRANSPORTATION • BUREAU OF HIGHWAY DESIGN			
WETLAND IMPACT PLAN			
DGN	STATE PROJECT NO.	SHEET NO.	TOTAL SHEETS
13065WETL	13065	6	28

MATCH TO SHEET 07

SDR PROCESSED	DATE	2/6/2020
NEW DESIGN	DATE	2/6/2020
SHEET CHECKED	DATE	2/6/2020
AS BUILT DETAILS	DATE	

REVISIONS AFTER PROPOSAL	STATION	DESCRIPTION

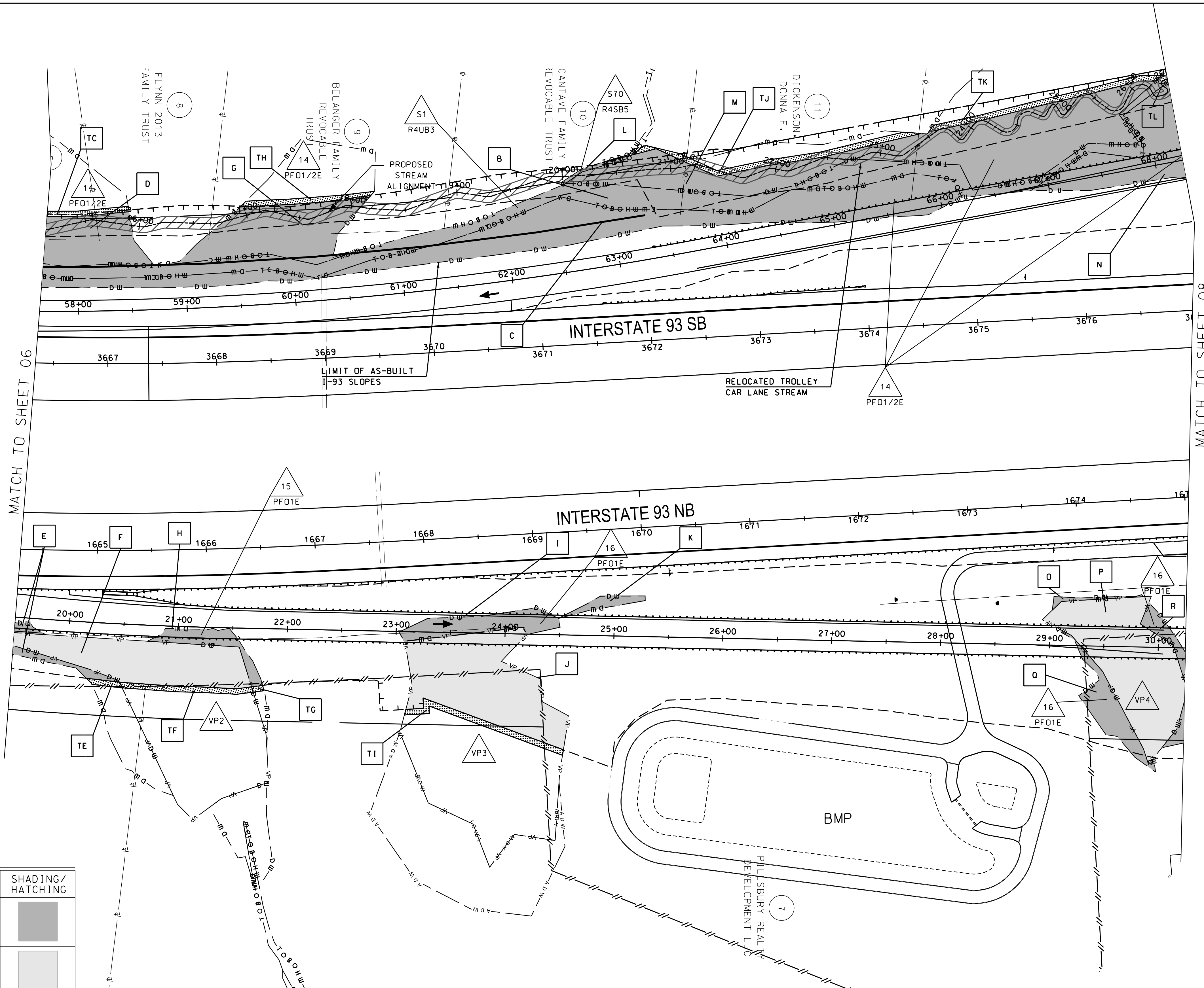
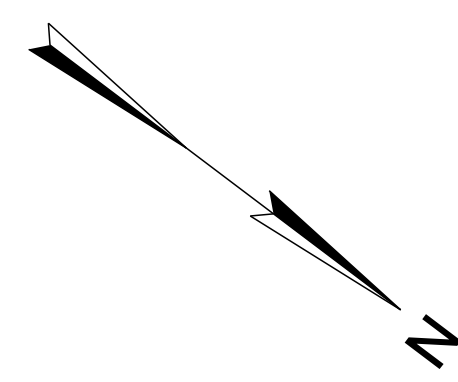

MATCH TO SHEET 06

MATCH TO SHEET 08

LEGEND

TYPE OF WETLAND IMPACT	SHADING/HATCHING
WETLANDS - NEW HAMPSHIRE WETLANDS BUREAU & ARMY CORP OF ENGINEERS (PERMANENT WETLAND)	
VERNAL POOL - NEW HAMPSHIRE WETLANDS BUREAU & ARMY CORP OF ENGINEERS (PERMANENT WETLAND)	
NEW HAMPSHIRE WETLANDS BUREAU & ARMY CORP OF ENGINEERS (TEMPORARY WETLAND)	
RELOCATED STREAM SELF MITIGATING	



STATE OF NEW HAMPSHIRE			
DEPARTMENT OF TRANSPORTATION • BUREAU OF HIGHWAY DESIGN			
WETLAND IMPACT PLAN			
DGN	STATE PROJECT NO.	SHEET NO.	TOTAL SHEETS
13065WETL	13065	7	28

SDR PROCESSED	DATE	2/6/2020	
NEW DESIGN	EMM	DATE	2/6/2020
SHEET CHECKED	NGF	DATE	2/6/2020
AS BUILT DETAILS		DATE	

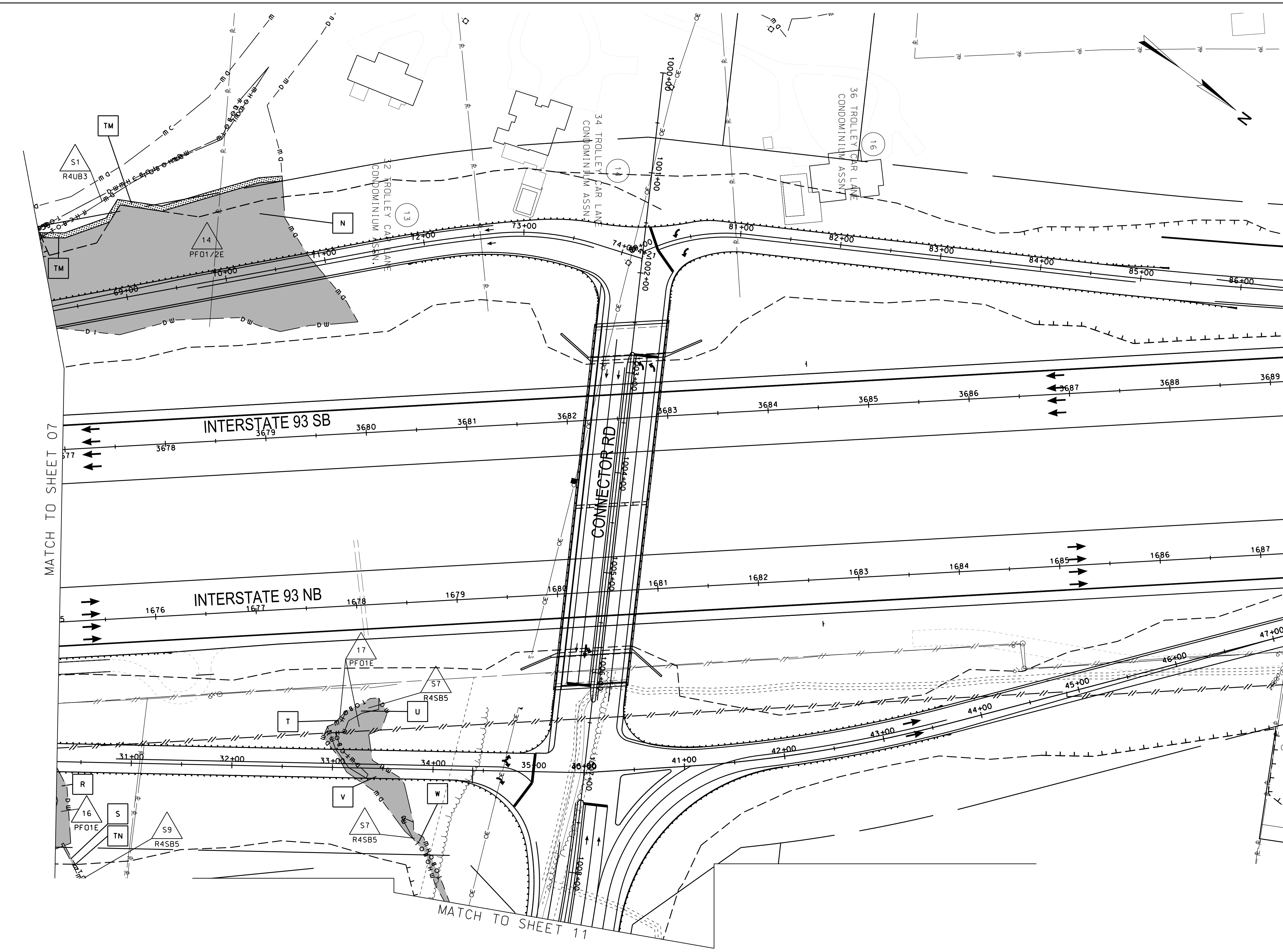

LEGEND

TYPE OF WETLAND IMPACT	SHADING/HATCHING
WETLANDS - NEW HAMPSHIRE WETLANDS BUREAU & ARMY CORP OF ENGINEERS (PERMANENT WETLAND)	
VERNAL POOL - NEW HAMPSHIRE WETLANDS BUREAU & ARMY CORP OF ENGINEERS (PERMANENT WETLAND)	
NEW HAMPSHIRE WETLANDS BUREAU & ARMY CORP OF ENGINEERS (TEMPORARY WETLAND)	

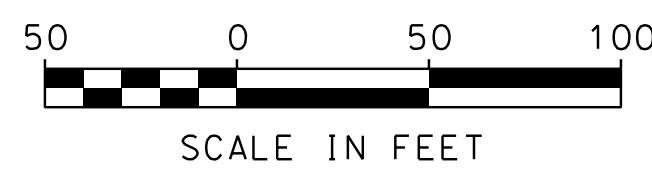

STATE OF NEW HAMPSHIRE			
DEPARTMENT OF TRANSPORTATION • BUREAU OF HIGHWAY DESIGN			
WETLAND IMPACT PLAN			
DGN	STATE PROJECT NO.	SHEET NO.	TOTAL SHEETS
13065WETL	13065	8	28

SDR PROCESSED	DATE	2/6/2020
NEW DESIGN	DATE	2/6/2020
SHEET CHECKED	DATE	2/6/2020
AS BUILT DETAILS	DATE	

REVISIONS AFTER PROPOSAL	STATION	DESCRIPTION

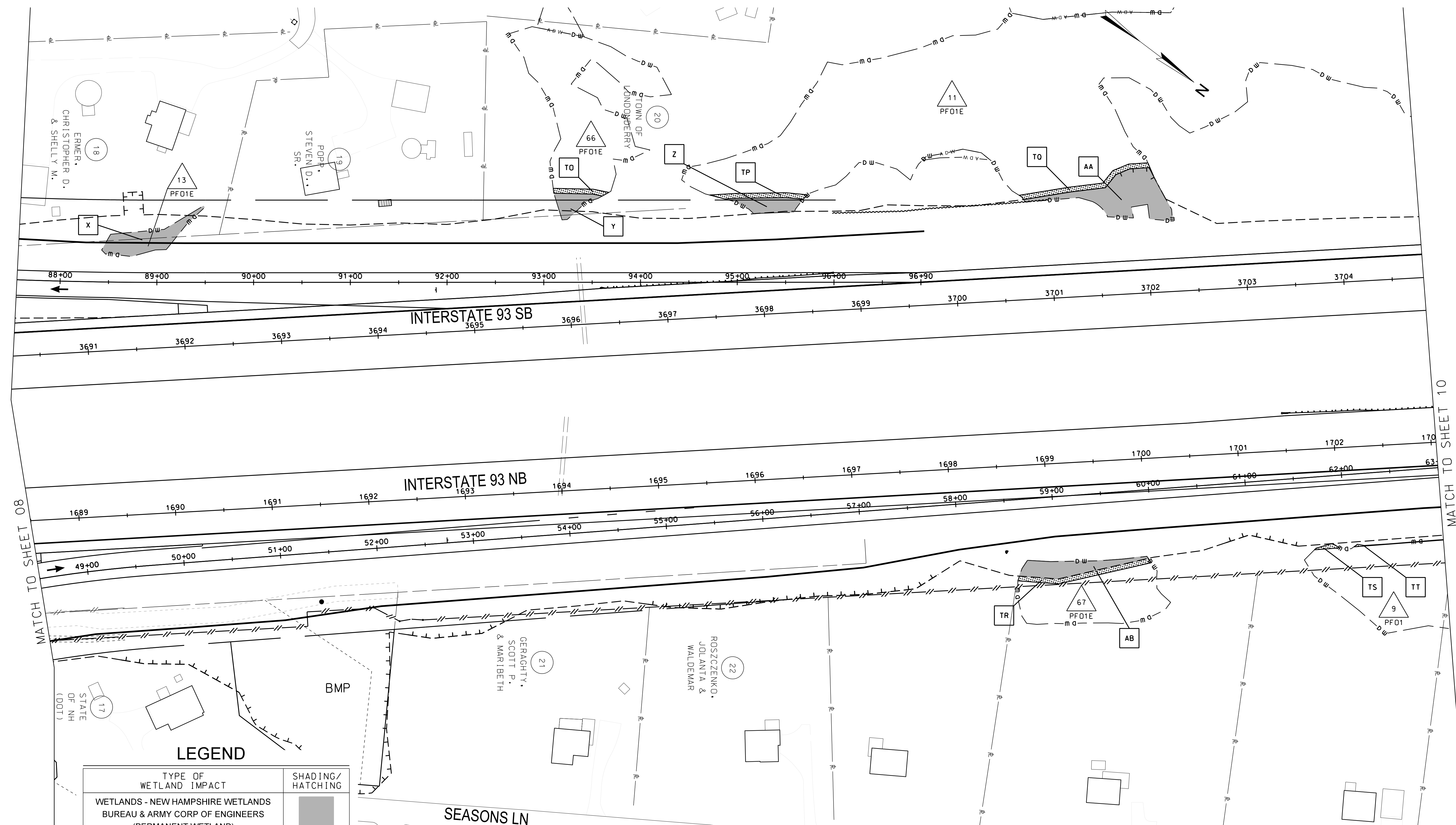

LEGEND

TYPE OF WETLAND IMPACT	SHADING/HATCHING
WETLANDS - NEW HAMPSHIRE WETLANDS BUREAU & ARMY CORP OF ENGINEERS (PERMANENT WETLAND)	
VERNAL POOL - NEW HAMPSHIRE WETLANDS BUREAU & ARMY CORP OF ENGINEERS (PERMANENT WETLAND)	
NEW HAMPSHIRE WETLANDS BUREAU & ARMY CORP OF ENGINEERS (TEMPORARY WETLAND)	

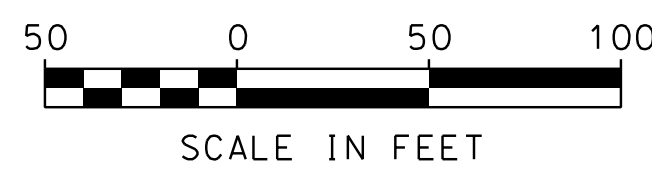

STATE OF NEW HAMPSHIRE			
DEPARTMENT OF TRANSPORTATION • BUREAU OF HIGHWAY DESIGN			
WETLAND IMPACT PLAN			
DGN	STATE PROJECT NO.	SHEET NO.	TOTAL SHEETS
13065WETL	13065	9	28

MATCH TO SHEET 08

MATCH TO SHEET 10

REVISIONS AFTER PROPOSAL

NUMBER	DATE	STATION	DESCRIPTION

SDR PROCESSED	DATE	DATE	DATE	DATE
NEW DESIGN	EMM	DATE	2/6/2020	
SHEET CHECKED	NGF	DATE	2/6/2020	
AS BUILT DETAILS		DATE		

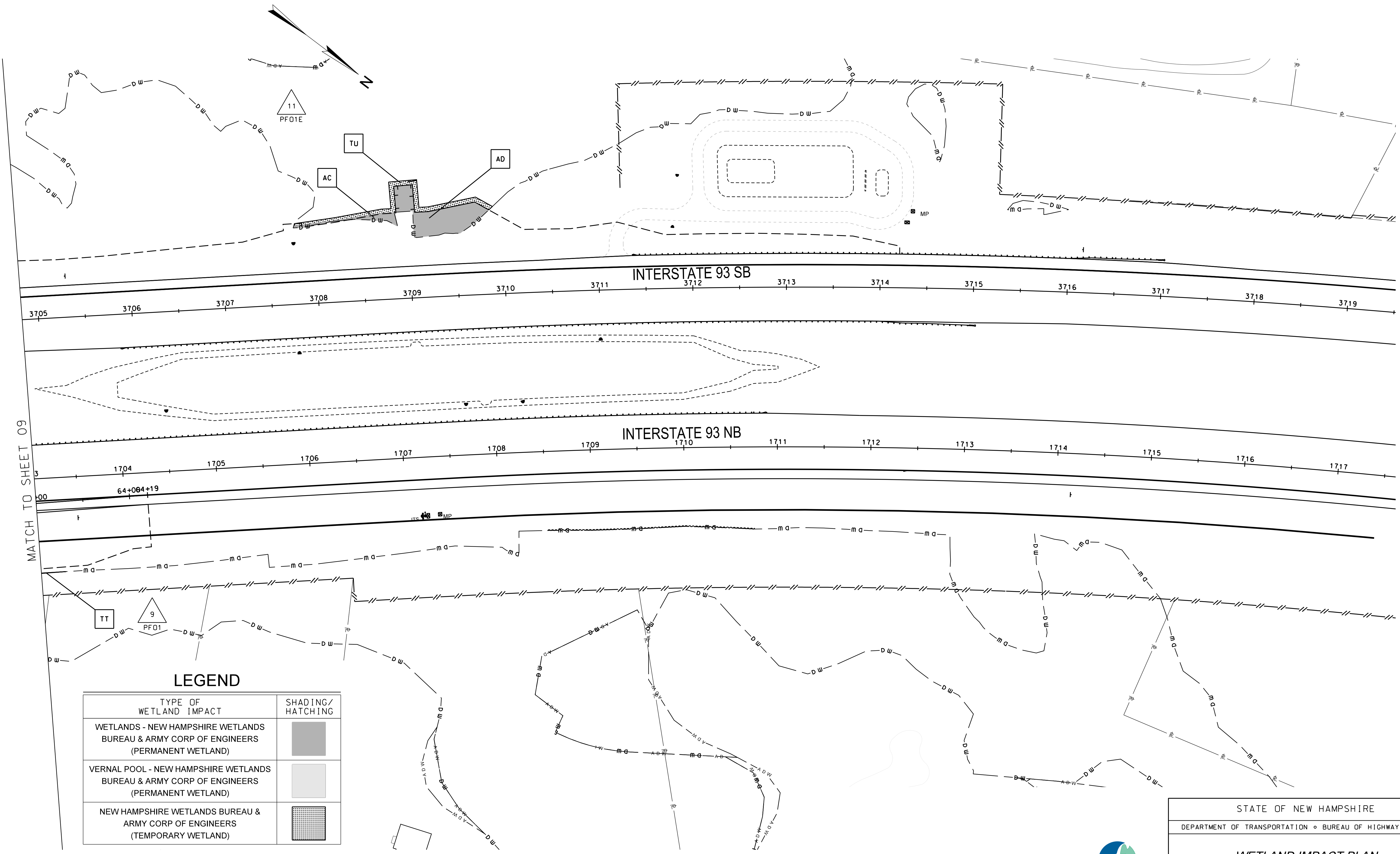

LEGEND

TYPE OF WETLAND IMPACT	SHADING/HATCHING
WETLANDS - NEW HAMPSHIRE WETLANDS BUREAU & ARMY CORP OF ENGINEERS (PERMANENT WETLAND)	
VERNAL POOL - NEW HAMPSHIRE WETLANDS BUREAU & ARMY CORP OF ENGINEERS (PERMANENT WETLAND)	
NEW HAMPSHIRE WETLANDS BUREAU & ARMY CORP OF ENGINEERS (TEMPORARY WETLAND)	



STATE OF NEW HAMPSHIRE			
DEPARTMENT OF TRANSPORTATION • BUREAU OF HIGHWAY DESIGN			
WETLAND IMPACT PLAN			
DGN	STATE PROJECT NO.	SHEET NO.	TOTAL SHEETS
13065WETL	13065	10	28

SDR PROCESSED	DATE	2/6/2020
NEW DESIGN	DATE	2/6/2020
SHEET CHECKED	DATE	2/6/2020
AS BUILT DETAILS	DATE	

REVISIONS AFTER PROPOSAL	STATION	DESCRIPTION

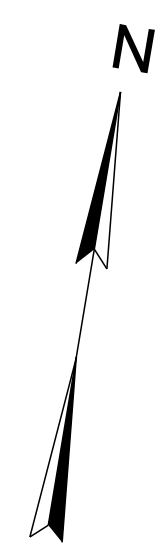

MATCH TO SHET 08

MATCH TO SHEET 12

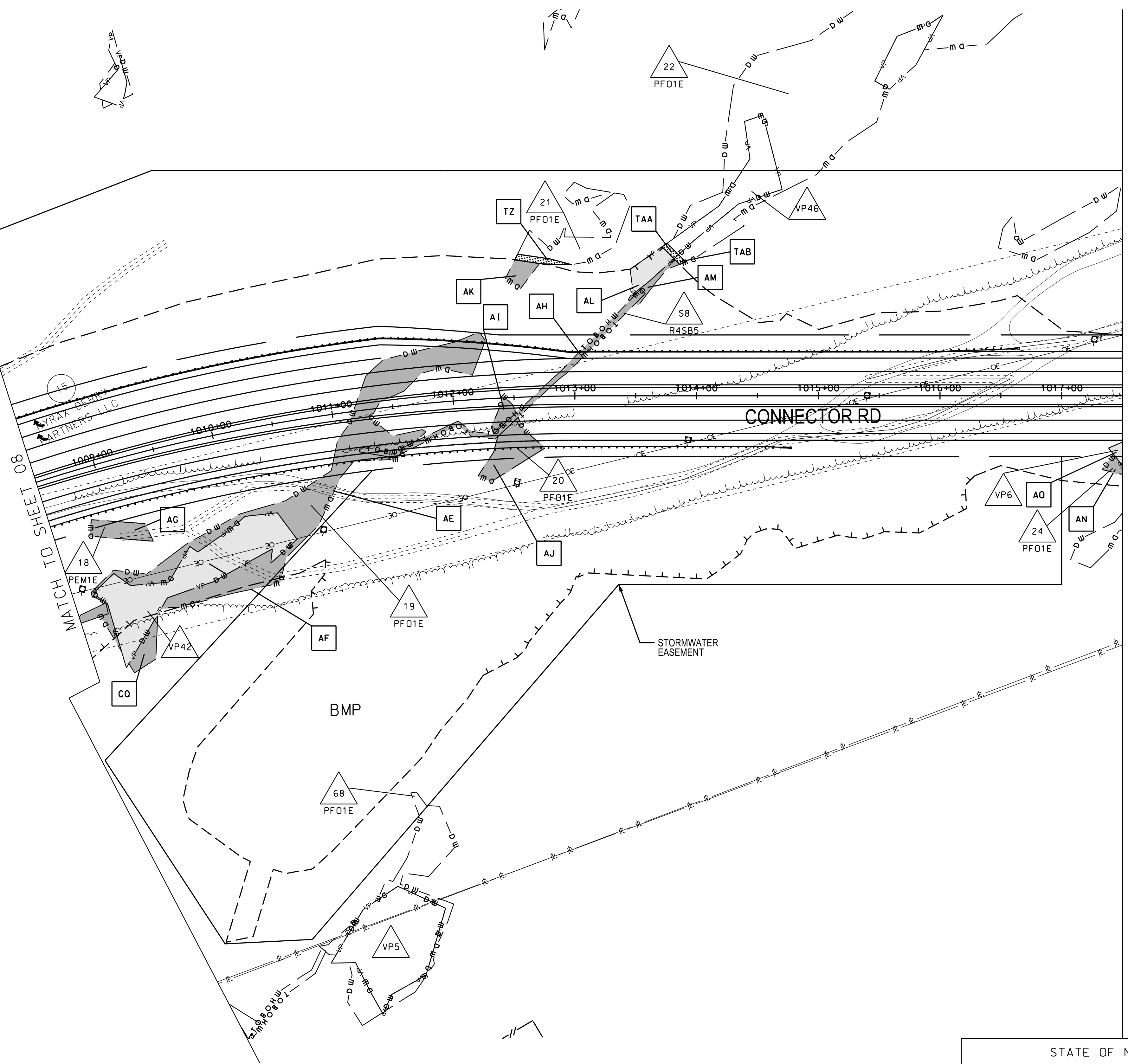

LEGEND

TYPE OF WETLAND IMPACT	SHADING/HATCHING
WETLANDS - NEW HAMPSHIRE WETLANDS BUREAU & ARMY CORP OF ENGINEERS (PERMANENT WETLAND)	
VERNAL POOL - NEW HAMPSHIRE WETLANDS BUREAU & ARMY CORP OF ENGINEERS (PERMANENT WETLAND)	
NEW HAMPSHIRE WETLANDS BUREAU & ARMY CORP OF ENGINEERS (TEMPORARY WETLAND)	



STATE OF NEW HAMPSHIRE			
DEPARTMENT OF TRANSPORTATION • BUREAU OF HIGHWAY DESIGN			
WETLAND IMPACT PLAN			
DGN	STATE PROJECT NO.	SHEET NO.	TOTAL SHEETS
13065WETL	13065	11	28

REVISIONS AFTER PROPOSAL

NUMBER	DATE	STATION	DESCRIPTION

SDR PROCESSED	DATE

NEW DESIGN	DATE
	2/6/2020

SHEET CHECKED	DATE
	2/6/2020

AS BUILT DETAILS	DATE

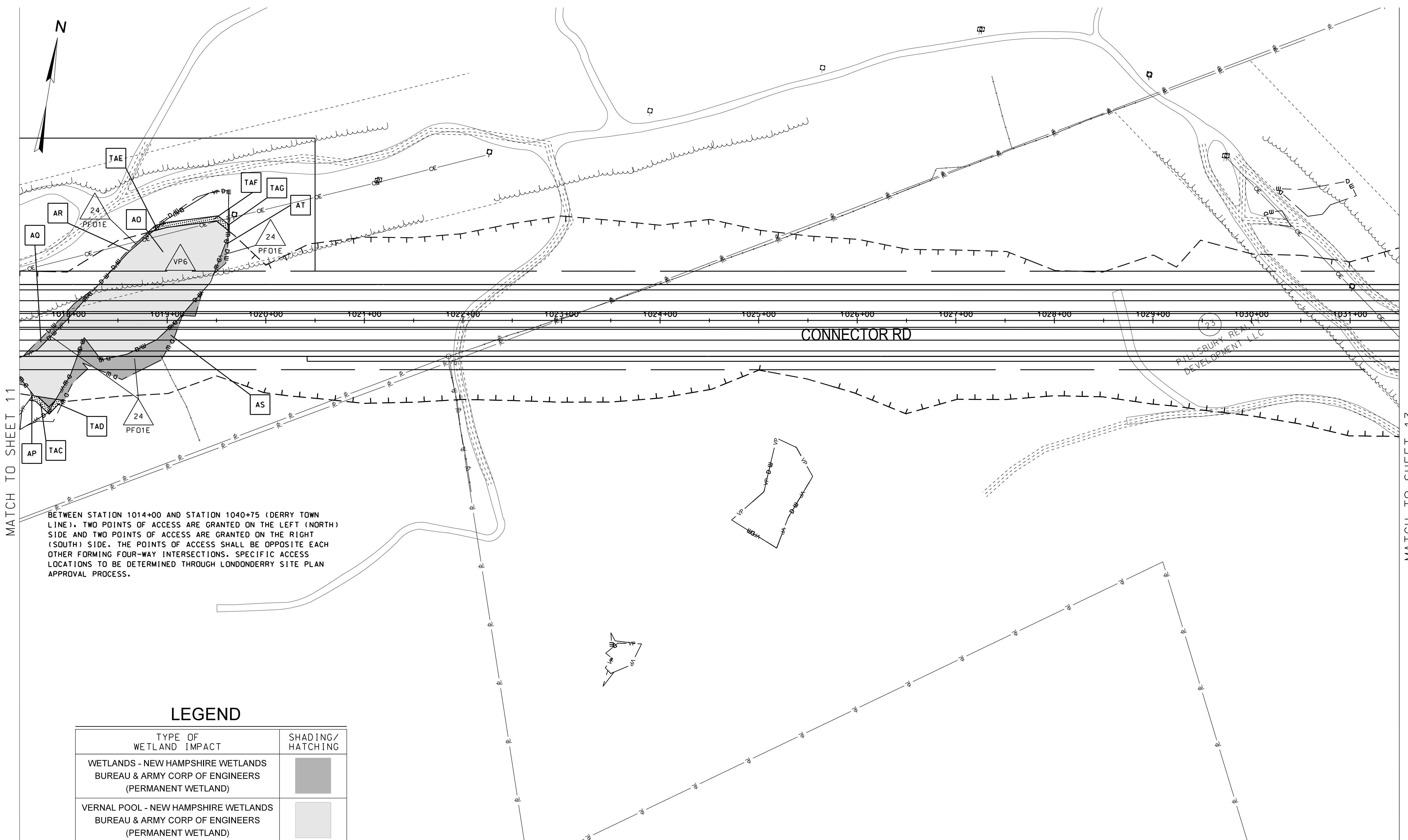

BETWEEN STATION 1014+00 AND STATION 1040+75 (DERRY TOWN LINE). TWO POINTS OF ACCESS ARE GRANTED ON THE LEFT (NORTH) SIDE AND TWO POINTS OF ACCESS ARE GRANTED ON THE RIGHT (SOUTH) SIDE. THE POINTS OF ACCESS SHALL BE OPPOSITE EACH OTHER FORMING FOUR-WAY INTERSECTIONS. SPECIFIC ACCESS LOCATIONS TO BE DETERMINED THROUGH LONDONDERRY SITE PLAN APPROVAL PROCESS.

LEGEND

TYPE OF WETLAND IMPACT	SHADING/HATCHING
WETLANDS - NEW HAMPSHIRE WETLANDS BUREAU & ARMY CORP OF ENGINEERS (PERMANENT WETLAND)	
VERNAL POOL - NEW HAMPSHIRE WETLANDS BUREAU & ARMY CORP OF ENGINEERS (PERMANENT WETLAND)	
NEW HAMPSHIRE WETLANDS BUREAU & ARMY CORP OF ENGINEERS (TEMPORARY WETLAND)	



STATE OF NEW HAMPSHIRE			
DEPARTMENT OF TRANSPORTATION • BUREAU OF HIGHWAY DESIGN			
WETLAND IMPACT PLAN			
DGN	STATE PROJECT NO.	SHEET NO.	TOTAL SHEETS
13065WETL	13065	12	28

MATCH TO SHEET 11

MATCH TO SHEET 13

SDR PROCESSED	DATE	2/6/2020
NEW DESIGN	DATE	2/6/2020
SHEET CHECKED	DATE	2/6/2020
AS BUILT DETAILS	DATE	

REVISIONS AFTER PROPOSAL	STATION	DESCRIPTION

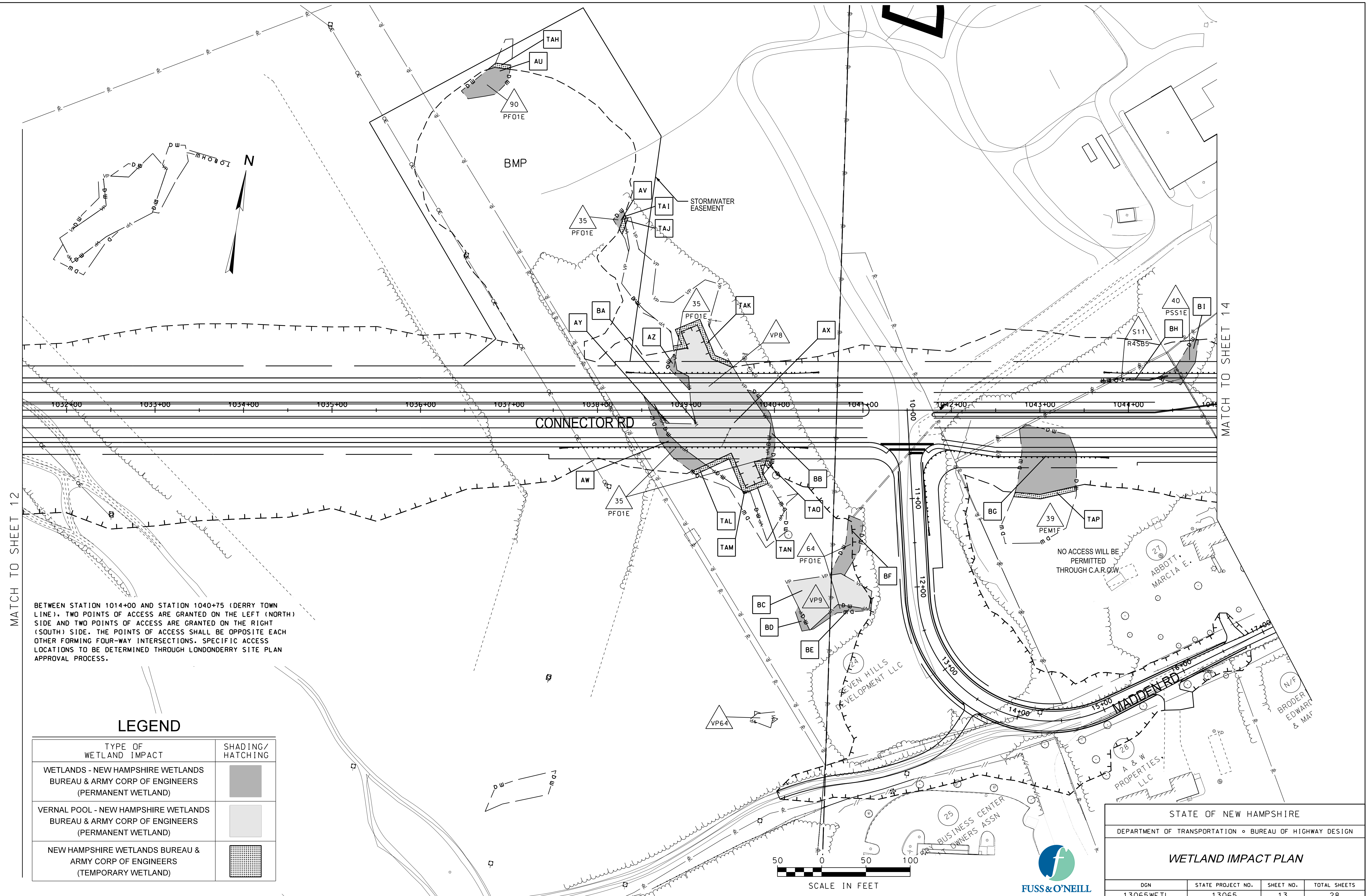

MATCH TO SHEET 12

MATCH TO SHEET 14

BETWEEN STATION 1014+00 AND STATION 1040+75 (DERRY TOWN LINE). TWO POINTS OF ACCESS ARE GRANTED ON THE LEFT (NORTH) SIDE AND TWO POINTS OF ACCESS ARE GRANTED ON THE RIGHT (SOUTH) SIDE. THE POINTS OF ACCESS SHALL BE OPPOSITE EACH OTHER FORMING FOUR-WAY INTERSECTIONS. SPECIFIC ACCESS LOCATIONS TO BE DETERMINED THROUGH LONDONDERRY SITE PLAN APPROVAL PROCESS.

LEGEND

TYPE OF WETLAND IMPACT	SHADING/HATCHING
WETLANDS - NEW HAMPSHIRE WETLANDS BUREAU & ARMY CORP OF ENGINEERS (PERMANENT WETLAND)	
VERNAL POOL - NEW HAMPSHIRE WETLANDS BUREAU & ARMY CORP OF ENGINEERS (PERMANENT WETLAND)	
NEW HAMPSHIRE WETLANDS BUREAU & ARMY CORP OF ENGINEERS (TEMPORARY WETLAND)	



STATE OF NEW HAMPSHIRE			
DEPARTMENT OF TRANSPORTATION • BUREAU OF HIGHWAY DESIGN			
WETLAND IMPACT PLAN			
DGN	STATE PROJECT NO.	SHEET NO.	TOTAL SHEETS
13065WETL	13065	13	28

SDR PROCESSED	DATE	2/6/2020	STATION	
NEW DESIGN	EMM	DATE	2/6/2020	
SHEET CHECKED	NCF	DATE	2/6/2020	
AS BUILT DETAILS		DATE		

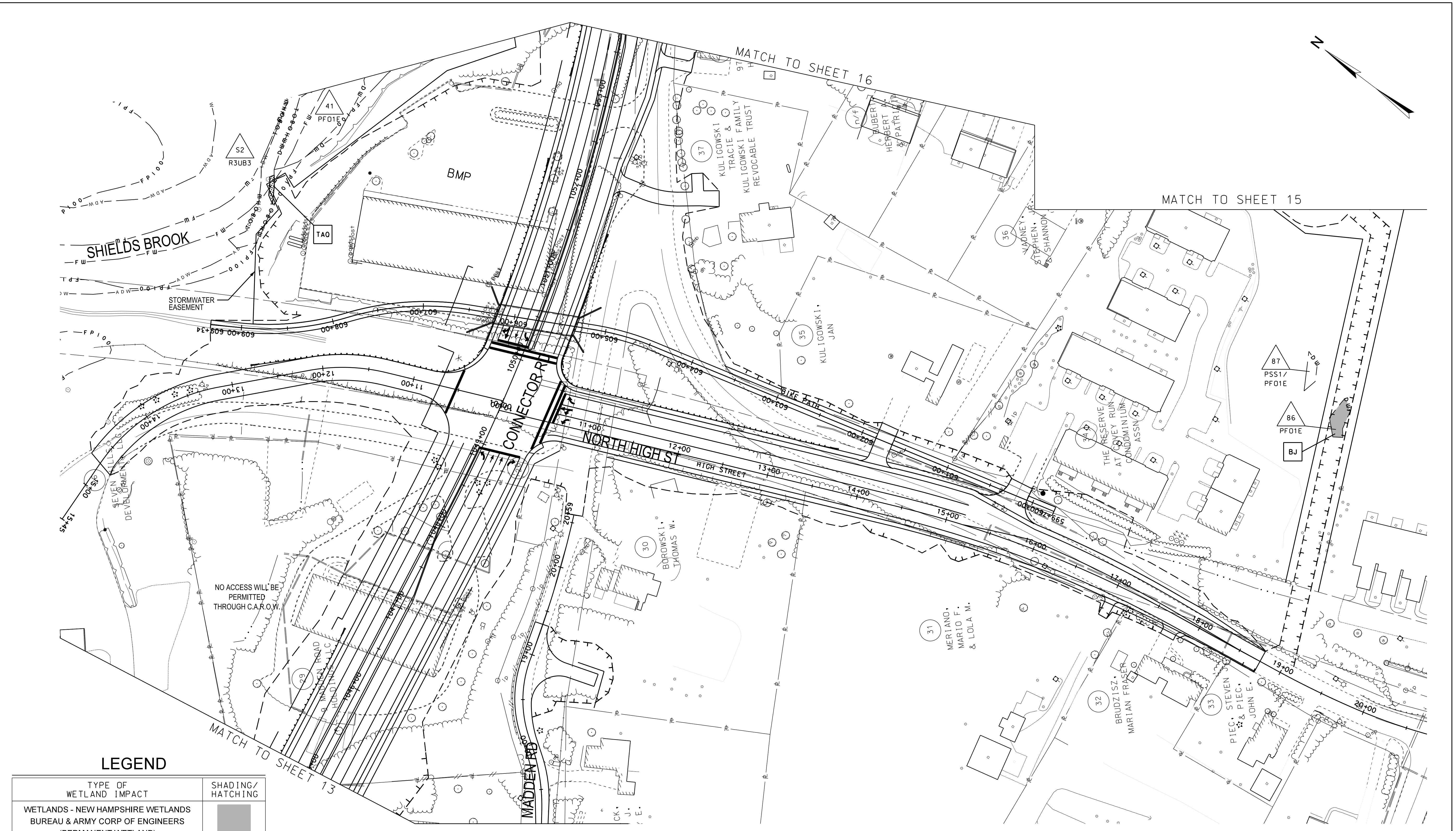

LEGEND

TYPE OF WETLAND IMPACT	SHADING/HATCHING
WETLANDS - NEW HAMPSHIRE WETLANDS BUREAU & ARMY CORP OF ENGINEERS (PERMANENT WETLAND)	
VERNAL POOL - NEW HAMPSHIRE WETLANDS BUREAU & ARMY CORP OF ENGINEERS (PERMANENT WETLAND)	
NEW HAMPSHIRE WETLANDS BUREAU & ARMY CORP OF ENGINEERS (TEMPORARY WETLAND)	



STATE OF NEW HAMPSHIRE			
DEPARTMENT OF TRANSPORTATION • BUREAU OF HIGHWAY DESIGN			
WETLAND IMPACT PLAN			
DGN	STATE PROJECT NO.	SHEET NO.	TOTAL SHEETS
13065WETL	13065	14	28

SDR PROCESSED	DATE	2/6/2020	STATION	
NEW DESIGN	DATE	2/6/2020	STATION	
SHEET CHECKED	DATE	2/6/2020	STATION	
AS BUILT DETAILS	DATE		STATION	

REVISIONS AFTER PROPOSAL

NUMBER	DATE	STATION	DESCRIPTION

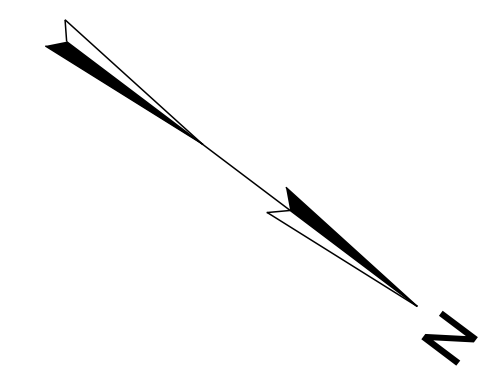
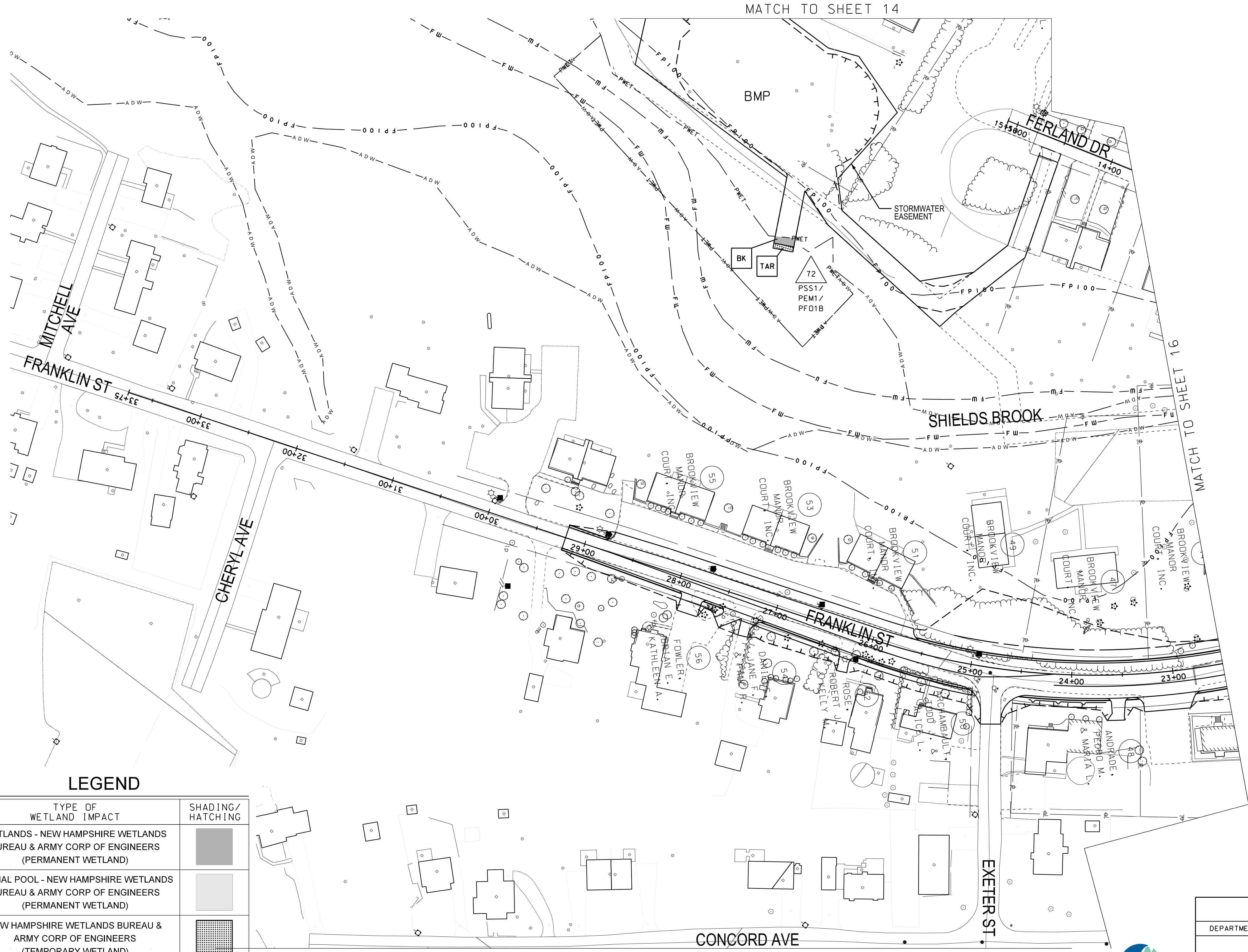

LEGEND

TYPE OF WETLAND IMPACT	SHADING/HATCHING
WETLANDS - NEW HAMPSHIRE WETLANDS BUREAU & ARMY CORP OF ENGINEERS (PERMANENT WETLAND)	
VERNAL POOL - NEW HAMPSHIRE WETLANDS BUREAU & ARMY CORP OF ENGINEERS (PERMANENT WETLAND)	
NEW HAMPSHIRE WETLANDS BUREAU & ARMY CORP OF ENGINEERS (TEMPORARY WETLAND)	

MATCH TO SHEET 18

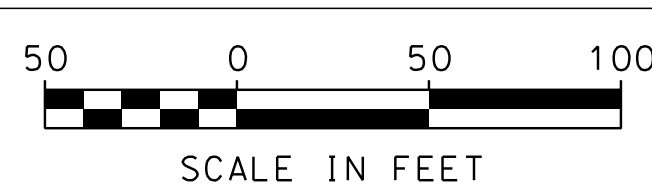

STATE OF NEW HAMPSHIRE			
DEPARTMENT OF TRANSPORTATION • BUREAU OF HIGHWAY DESIGN			
WETLAND IMPACT PLAN			
DGN	STATE PROJECT NO.	SHEET NO.	TOTAL SHEETS
13065WETL	13065	15	28

SDR PROCESSED	DATE	2/6/2020	
NEW DESIGN	EMM	DATE	2/6/2020
SHEET CHECKED	NCF	DATE	2/6/2020
AS BUILT DETAILS	DATE		

REVISIONS AFTER PROPOSAL	DESCRIPTION	STATION

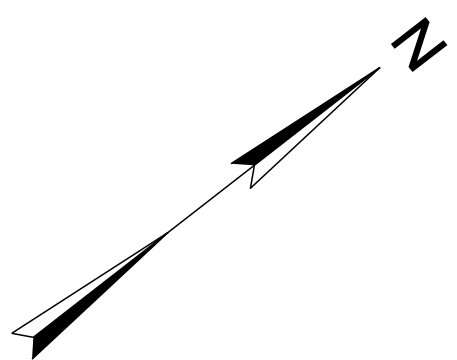

LEGEND

TYPE OF WETLAND IMPACT	SHADING/HATCHING
WETLANDS - NEW HAMPSHIRE WETLANDS BUREAU & ARMY CORP OF ENGINEERS (PERMANENT WETLAND)	
VERNAL POOL - NEW HAMPSHIRE WETLANDS BUREAU & ARMY CORP OF ENGINEERS (PERMANENT WETLAND)	
NEW HAMPSHIRE WETLANDS BUREAU & ARMY CORP OF ENGINEERS (TEMPORARY WETLAND)	



STATE OF NEW HAMPSHIRE			
DEPARTMENT OF TRANSPORTATION • BUREAU OF HIGHWAY DESIGN			
WETLAND IMPACT PLAN			
DGN	STATE PROJECT NO.	SHEET NO.	TOTAL SHEETS
13065WETL	13065	16	28

MATCH TO SHEET 14

MATCH TO SHEET 15

MATCH TO SHEET 17

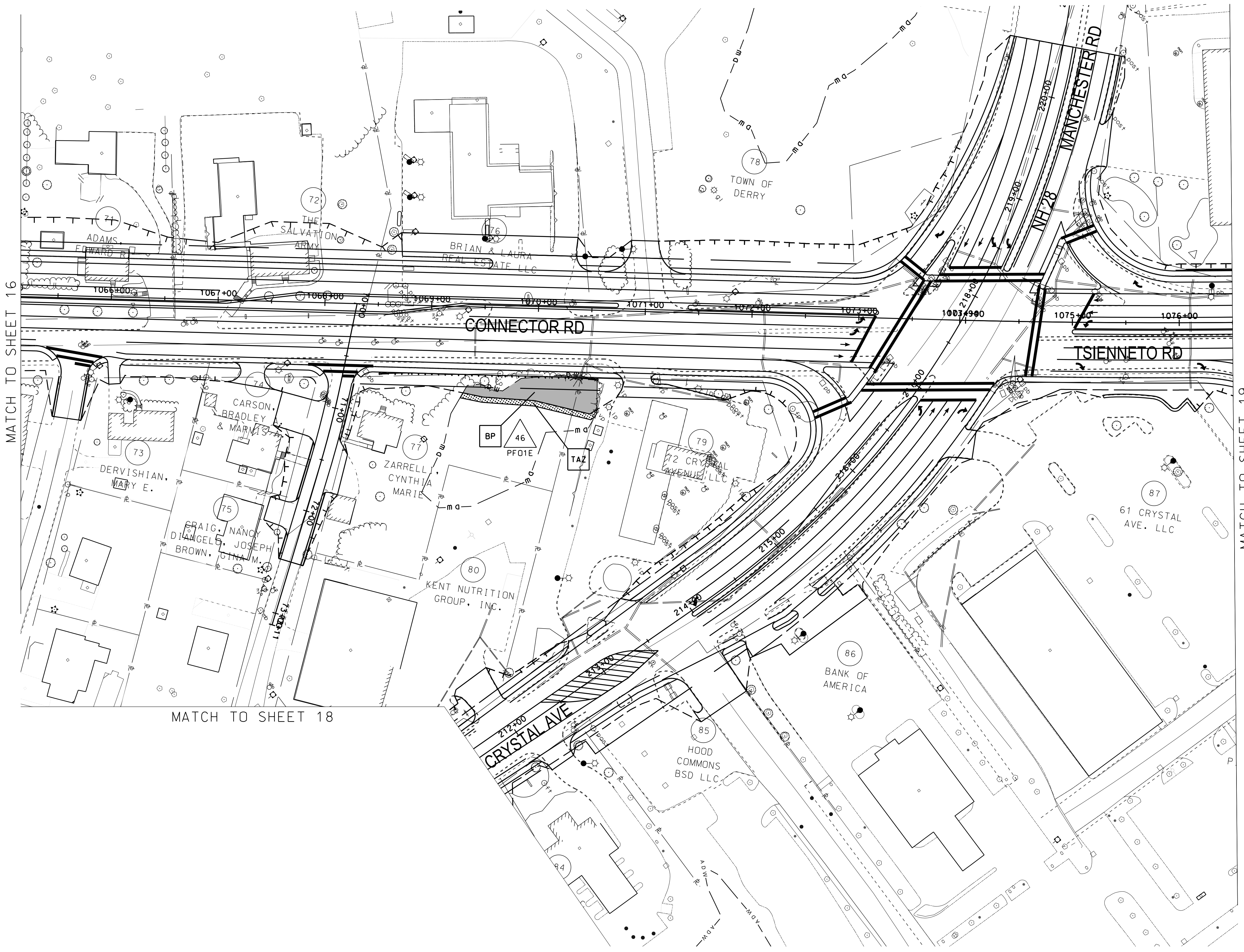
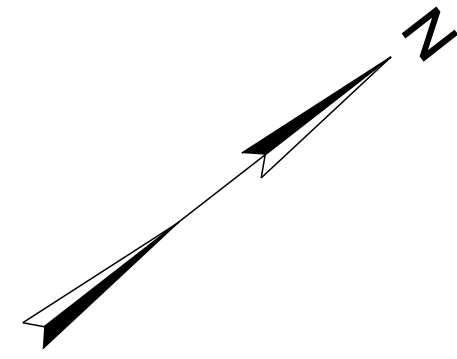

MATCH TO SHEET 16

MATCH TO SHEET 18

MATCH TO SHEET 19

SDR PROCESSED	DATE	2/6/2020
NEW DESIGN	DATE	2/6/2020
SHEET CHECKED	DATE	2/6/2020
AS BUILT DETAILS	DATE	

REVISIONS AFTER PROPOSAL	STATION	DESCRIPTION

LEGEND

TYPE OF WETLAND IMPACT	SHADING/HATCHING
WETLANDS - NEW HAMPSHIRE WETLANDS BUREAU & ARMY CORP OF ENGINEERS (PERMANENT WETLAND)	
VERNAL POOL - NEW HAMPSHIRE WETLANDS BUREAU & ARMY CORP OF ENGINEERS (PERMANENT WETLAND)	
NEW HAMPSHIRE WETLANDS BUREAU & ARMY CORP OF ENGINEERS (TEMPORARY WETLAND)	



STATE OF NEW HAMPSHIRE			
DEPARTMENT OF TRANSPORTATION • BUREAU OF HIGHWAY DESIGN			
WETLAND IMPACT PLAN			
DGN	STATE PROJECT NO.	SHEET NO.	TOTAL SHEETS
13065WETL	13065	17	28

SDR PROCESSED	DATE	2/6/2020	STATION	
NEW DESIGN	DATE	2/6/2020	STATION	
SHEET CHECKED	DATE	2/6/2020	STATION	
AS BUILT DETAILS	DATE		STATION	

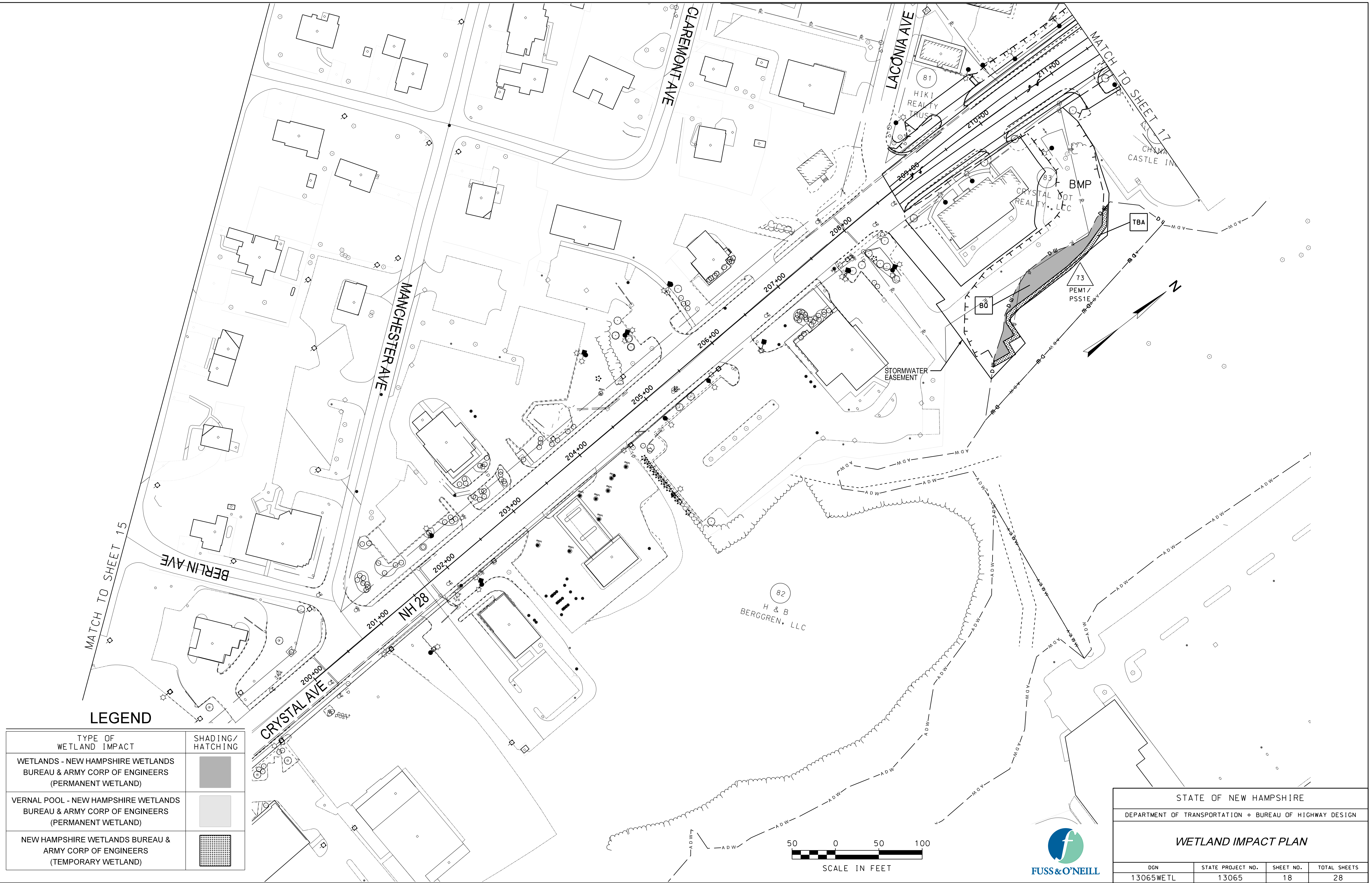

LEGEND

TYPE OF WETLAND IMPACT	SHADING/HATCHING
WETLANDS - NEW HAMPSHIRE WETLANDS BUREAU & ARMY CORP OF ENGINEERS (PERMANENT WETLAND)	
VERNAL POOL - NEW HAMPSHIRE WETLANDS BUREAU & ARMY CORP OF ENGINEERS (PERMANENT WETLAND)	
NEW HAMPSHIRE WETLANDS BUREAU & ARMY CORP OF ENGINEERS (TEMPORARY WETLAND)	



STATE OF NEW HAMPSHIRE			
DEPARTMENT OF TRANSPORTATION • BUREAU OF HIGHWAY DESIGN			
WETLAND IMPACT PLAN			
DGN	STATE PROJECT NO.	SHEET NO.	TOTAL SHEETS
13065WETL	13065	18	28

SDR PROCESSED	DATE	2/6/2020
NEW DESIGN	DATE	2/6/2020
SHEET CHECKED	DATE	2/6/2020
AS BUILT DETAILS	DATE	

REVISIONS AFTER PROPOSAL	DESCRIPTION
NUMBER	DATE
STATION	STATION

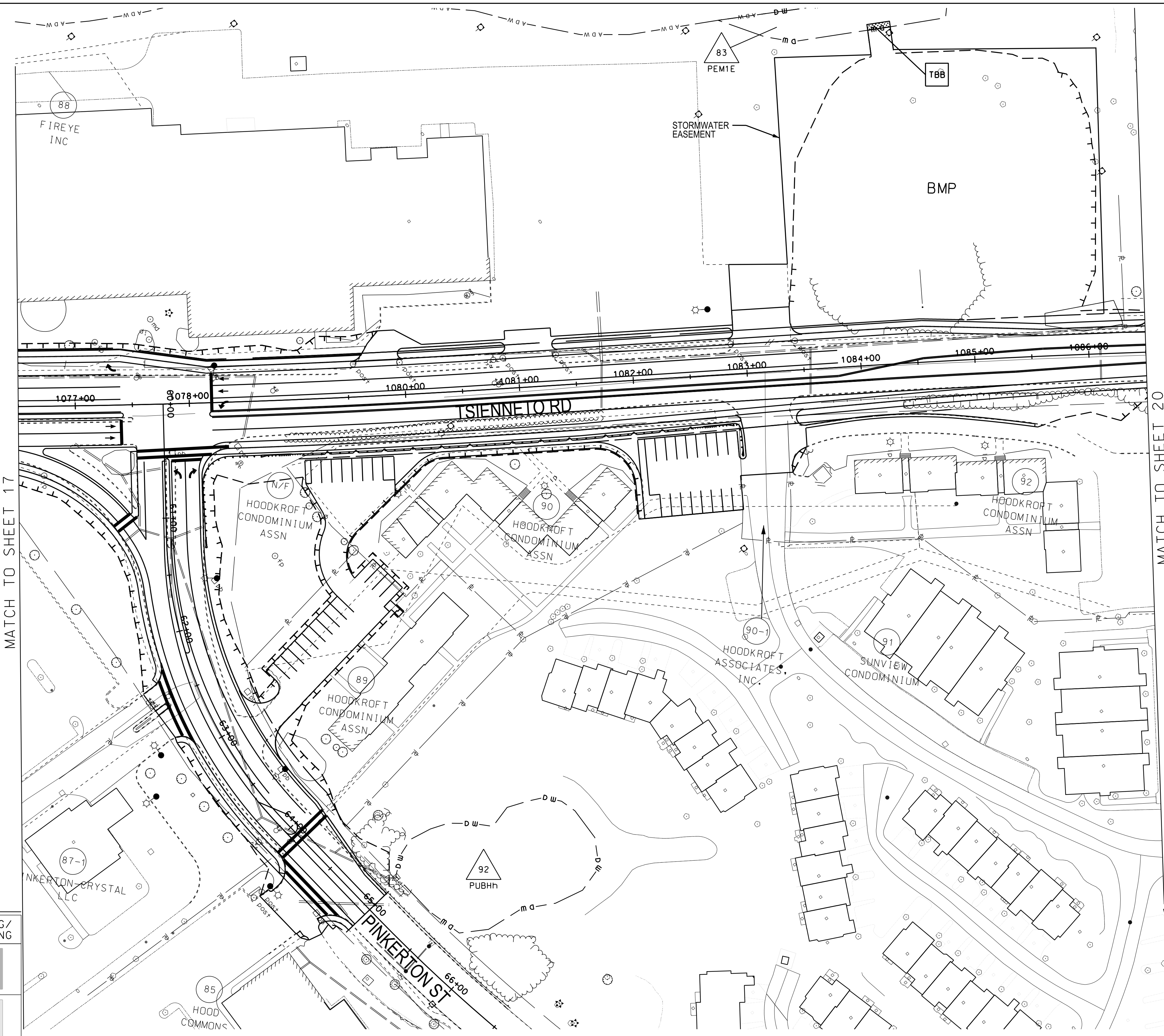

LEGEND

TYPE OF WETLAND IMPACT	SHADING/HATCHING
WETLANDS - NEW HAMPSHIRE WETLANDS BUREAU & ARMY CORP OF ENGINEERS (PERMANENT WETLAND)	
VERNAL POOL - NEW HAMPSHIRE WETLANDS BUREAU & ARMY CORP OF ENGINEERS (PERMANENT WETLAND)	
NEW HAMPSHIRE WETLANDS BUREAU & ARMY CORP OF ENGINEERS (TEMPORARY WETLAND)	

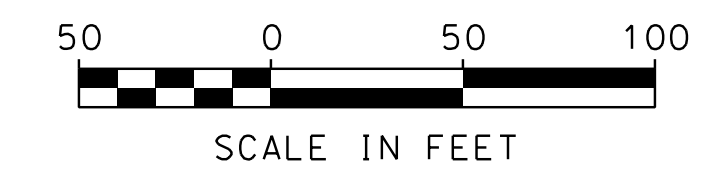

STATE OF NEW HAMPSHIRE			
DEPARTMENT OF TRANSPORTATION • BUREAU OF HIGHWAY DESIGN			
WETLAND IMPACT PLAN			
DGN	STATE PROJECT NO.	SHEET NO.	TOTAL SHEETS
13065WETL	13065	19	28

REVISIONS AFTER PROPOSAL

NUMBER	DATE	STATION	DESCRIPTION

SDR PROCESSED	DATE

NEW DESIGN	DATE

SHEET CHECKED	DATE

AS BUILT DETAILS	DATE

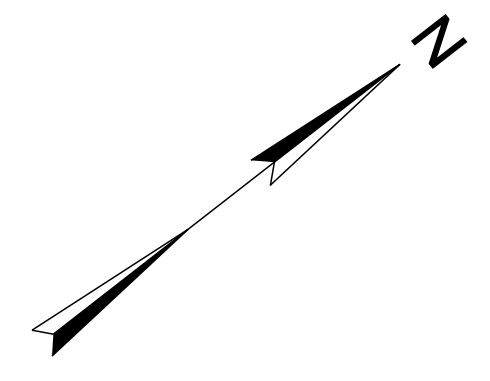
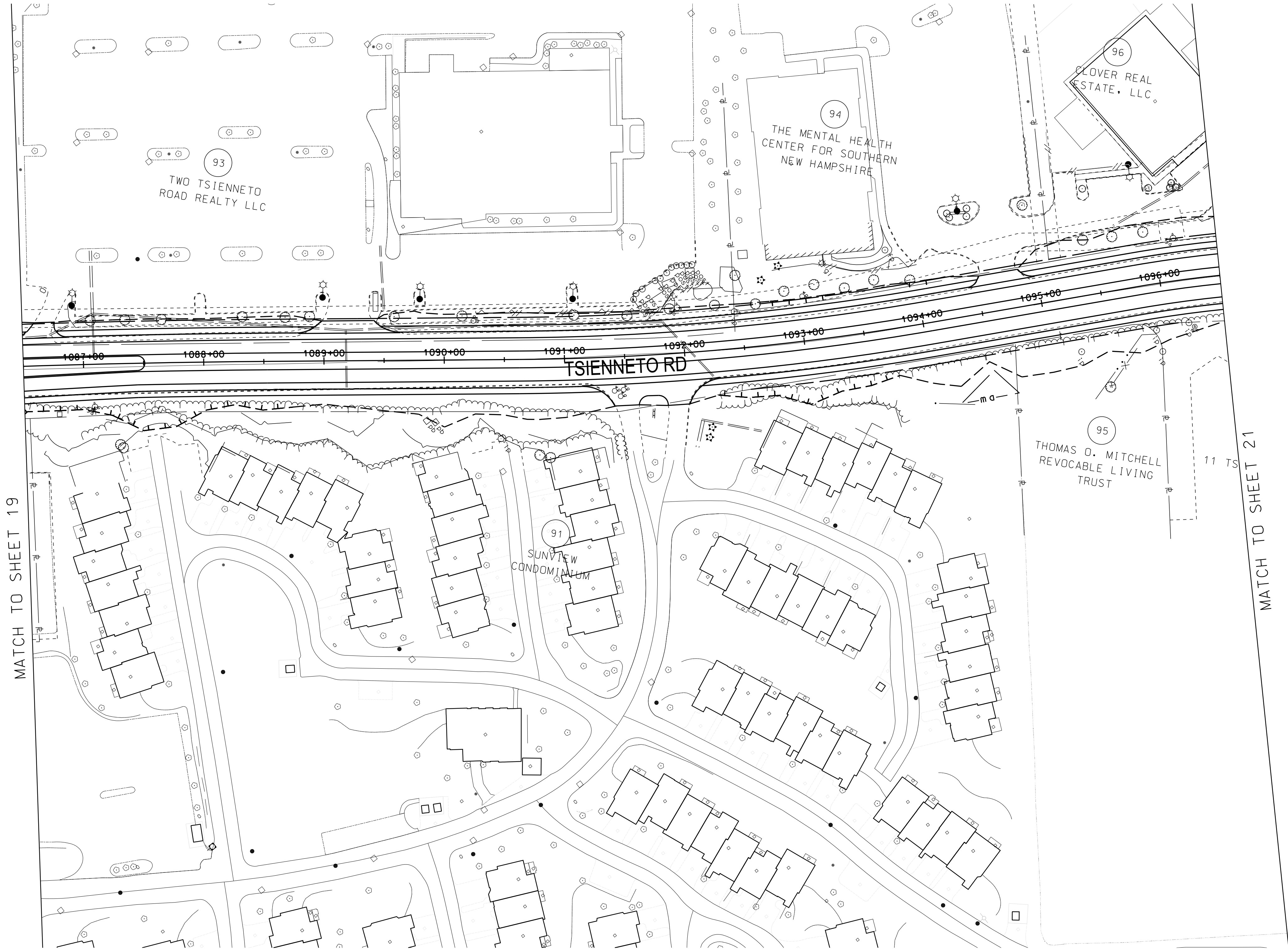

LEGEND

TYPE OF WETLAND IMPACT	SHADING/HATCHING
WETLANDS - NEW HAMPSHIRE WETLANDS BUREAU & ARMY CORP OF ENGINEERS (PERMANENT WETLAND)	
VERNAL POOL - NEW HAMPSHIRE WETLANDS BUREAU & ARMY CORP OF ENGINEERS (PERMANENT WETLAND)	
NEW HAMPSHIRE WETLANDS BUREAU & ARMY CORP OF ENGINEERS (TEMPORARY WETLAND)	

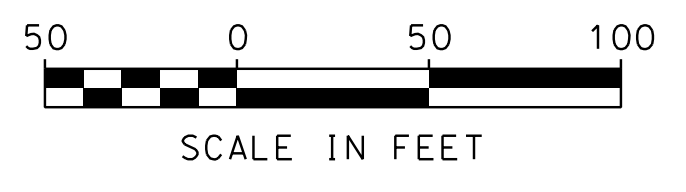

STATE OF NEW HAMPSHIRE			
DEPARTMENT OF TRANSPORTATION • BUREAU OF HIGHWAY DESIGN			
WETLAND IMPACT PLAN			
DGN	STATE PROJECT NO.	SHEET NO.	TOTAL SHEETS
13065WETL	13065	20	28

SDR PROCESSED	DATE	2/6/2020
NEW DESIGN	DATE	2/6/2020
SHEET CHECKED	DATE	2/6/2020
AS BUILT DETAILS	DATE	

REVISIONS AFTER PROPOSAL	DESCRIPTION
NUMBER	DATE
STATION	STATION

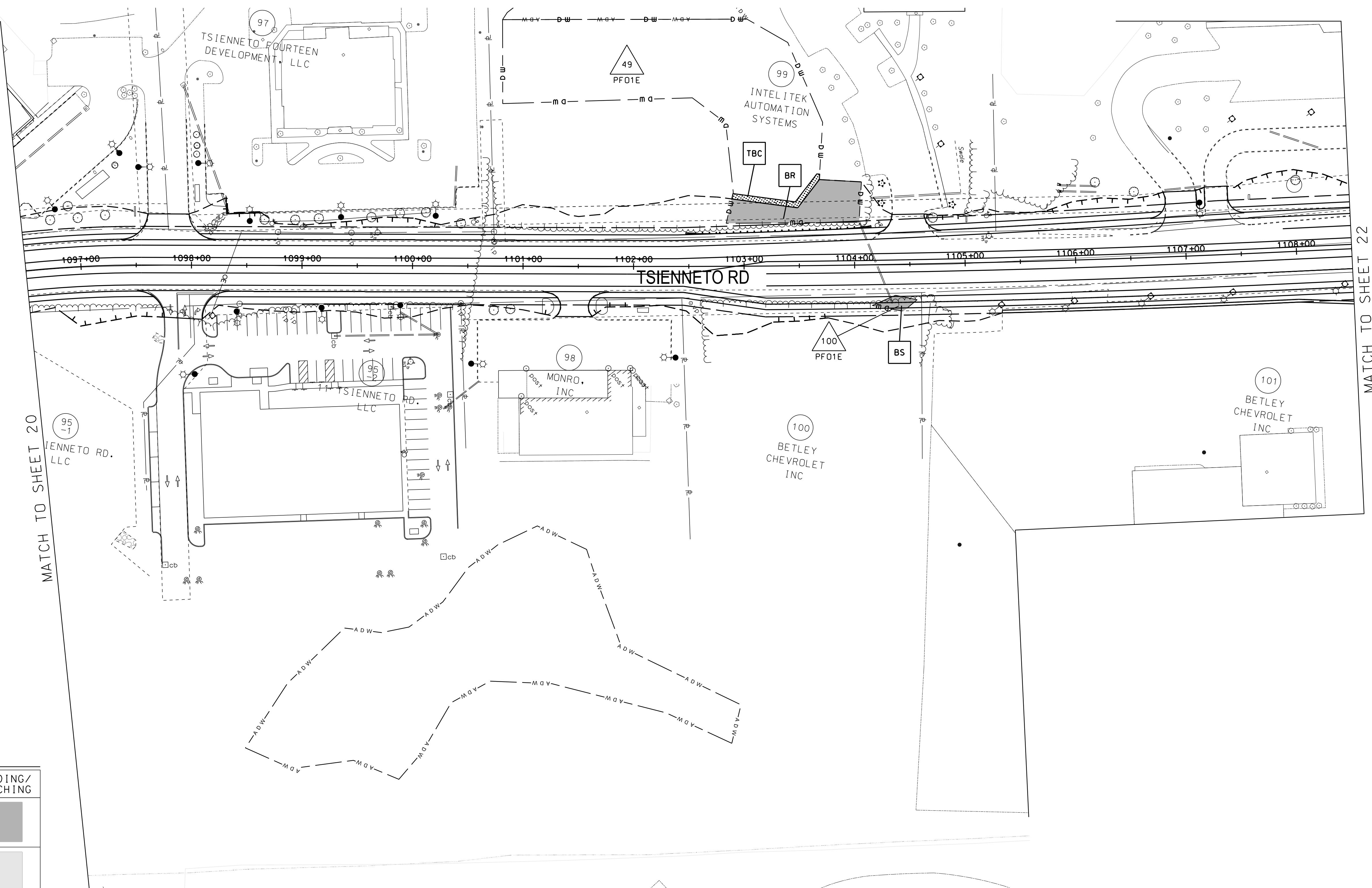
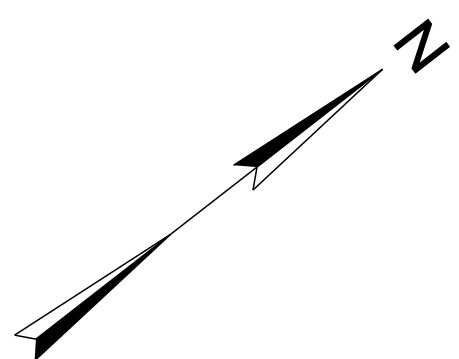

LEGEND

TYPE OF WETLAND IMPACT	SHADING/HATCHING
WETLANDS - NEW HAMPSHIRE WETLANDS BUREAU & ARMY CORP OF ENGINEERS (PERMANENT WETLAND)	
VERNAL POOL - NEW HAMPSHIRE WETLANDS BUREAU & ARMY CORP OF ENGINEERS (PERMANENT WETLAND)	
NEW HAMPSHIRE WETLANDS BUREAU & ARMY CORP OF ENGINEERS (TEMPORARY WETLAND)	

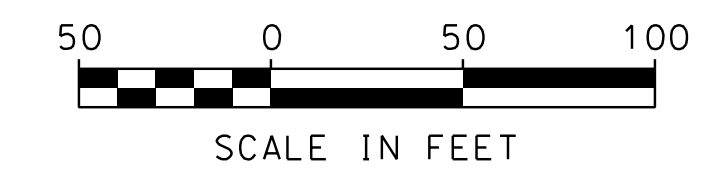

STATE OF NEW HAMPSHIRE			
DEPARTMENT OF TRANSPORTATION • BUREAU OF HIGHWAY DESIGN			
WETLAND IMPACT PLAN			
DGN	STATE PROJECT NO.	SHEET NO.	TOTAL SHEETS
13065WETL	13065	21	28

LEGEND

TYPE OF WETLAND IMPACT	SHADING/HATCHING
WETLANDS - NEW HAMPSHIRE WETLANDS BUREAU & ARMY CORP OF ENGINEERS (PERMANENT WETLAND)	
VERNAL POOL - NEW HAMPSHIRE WETLANDS BUREAU & ARMY CORP OF ENGINEERS (PERMANENT WETLAND)	
NEW HAMPSHIRE WETLANDS BUREAU & ARMY CORP OF ENGINEERS (TEMPORARY WETLAND)	

REVISIONS AFTER PROPOSAL		STATION		DESCRIPTION	
NUMBER	DATE	STATION	STATION	DESCRIPTION	DESCRIPTION

SDR PROCESSED	DATE	2/6/2020
NEW DESIGN	DATE	2/6/2020
SHEET CHECKED	DATE	2/6/2020
AS BUILT DETAILS	DATE	

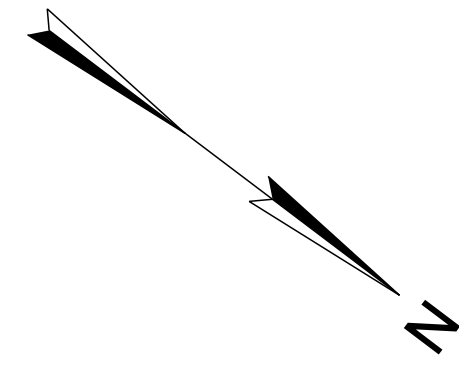
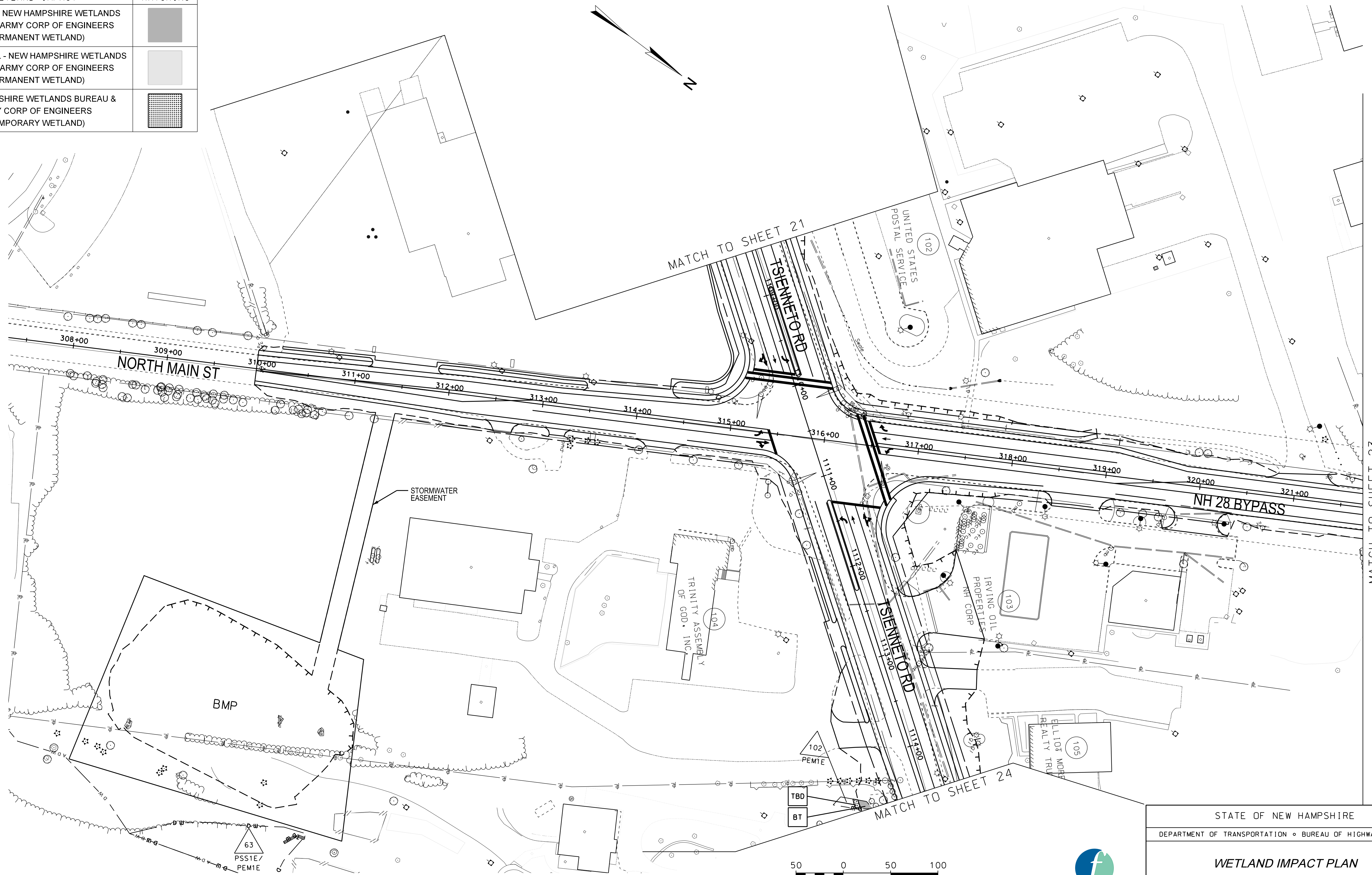

STATE OF NEW HAMPSHIRE DEPARTMENT OF TRANSPORTATION • BUREAU OF HIGHWAY DESIGN			
WETLAND IMPACT PLAN			
DGN	STATE PROJECT NO.	SHEET NO.	TOTAL SHEETS
13065WETL	13065	22	28

LEGEND

TYPE OF WETLAND IMPACT	SHADING/HATCHING
WETLANDS - NEW HAMPSHIRE WETLANDS BUREAU & ARMY CORP OF ENGINEERS (PERMANENT WETLAND)	
VERNAL POOL - NEW HAMPSHIRE WETLANDS BUREAU & ARMY CORP OF ENGINEERS (PERMANENT WETLAND)	
NEW HAMPSHIRE WETLANDS BUREAU & ARMY CORP OF ENGINEERS (TEMPORARY WETLAND)	

REVISIONS AFTER PROPOSAL		STATION	DESCRIPTION
NUMBER	DATE	STATION	DESCRIPTION

SDR PROCESSED	DATE
NEW DESIGN	2/6/2020
EMM	
SHEET CHECKED	2/6/2020
NGF	
AS BUILT DETAILS	



STATE OF NEW HAMPSHIRE			
DEPARTMENT OF TRANSPORTATION • BUREAU OF HIGHWAY DESIGN			
WETLAND IMPACT PLAN			
DGN	STATE PROJECT NO.	SHEET NO.	TOTAL SHEETS
13065WETL	13065	23	28

LEGEND

TYPE OF WETLAND IMPACT	SHADING/HATCHING
WETLANDS - NEW HAMPSHIRE WETLANDS BUREAU & ARMY CORP OF ENGINEERS (PERMANENT WETLAND)	[Solid Grey Box]
VERNAL POOL - NEW HAMPSHIRE WETLANDS BUREAU & ARMY CORP OF ENGINEERS (PERMANENT WETLAND)	[Light Grey Box]
NEW HAMPSHIRE WETLANDS BUREAU & ARMY CORP OF ENGINEERS (TEMPORARY WETLAND)	[Cross-hatched Box]

REVISIONS AFTER PROPOSAL		DESCRIPTION	
NUMBER	DATE	STATION	DESCRIPTION

SDR PROCESSED	DATE	2/6/2020
NEW DESIGN	EMM	2/6/2020
SHEET CHECKED	NGF	2/6/2020
AS BUILT DETAILS	DATE	

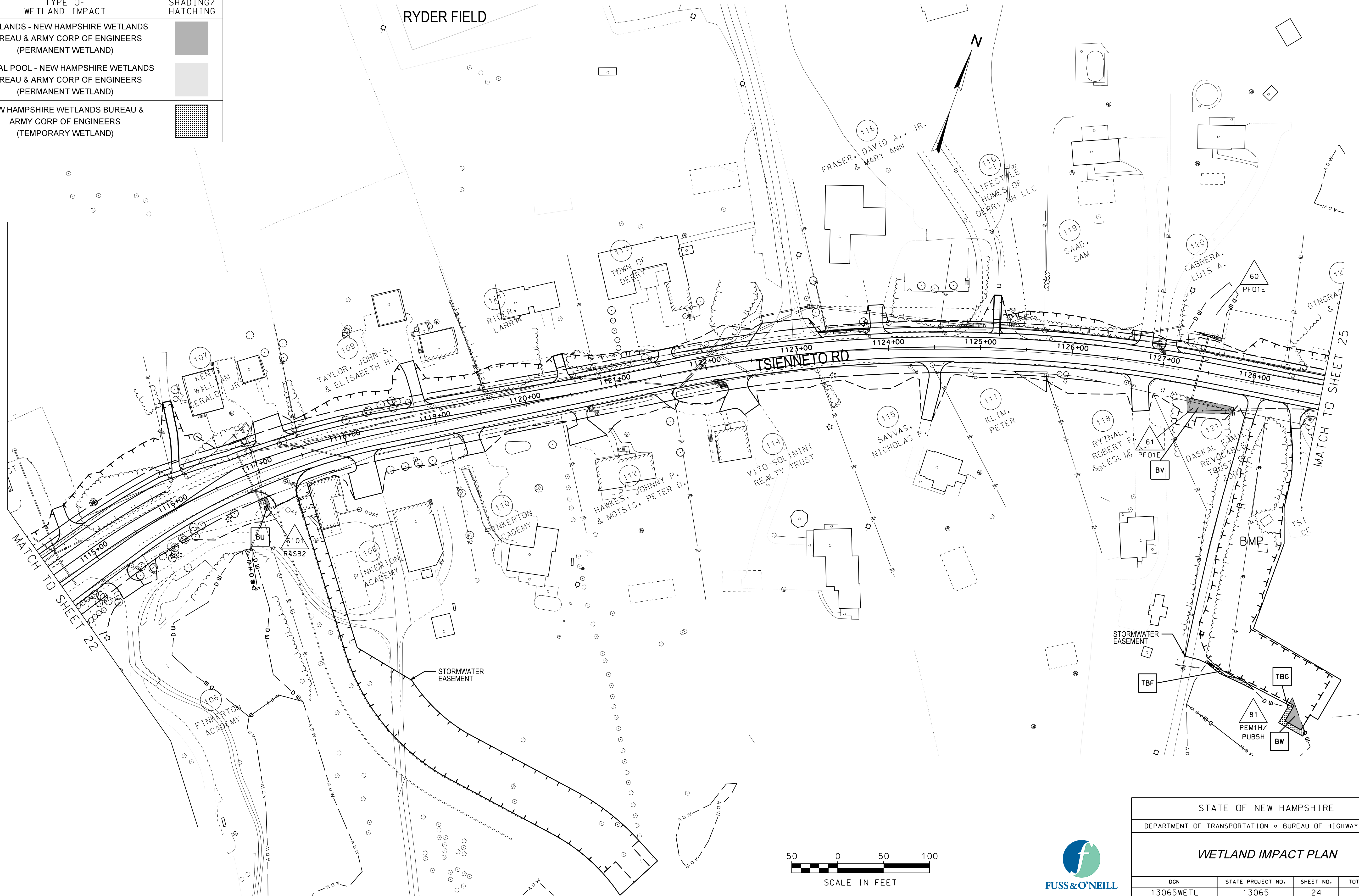

STATE OF NEW HAMPSHIRE			
DEPARTMENT OF TRANSPORTATION • BUREAU OF HIGHWAY DESIGN			
WETLAND IMPACT PLAN			
DGN	STATE PROJECT NO.	SHEET NO.	TOTAL SHEETS
13065WETL	13065	24	28



SDR PROCESSED	DATE	2/6/2020
NEW DESIGN	DATE	2/6/2020
SHEET CHECKED	DATE	2/6/2020
AS BUILT DETAILS	DATE	

REVISIONS AFTER PROPOSAL	DESCRIPTION	STATION

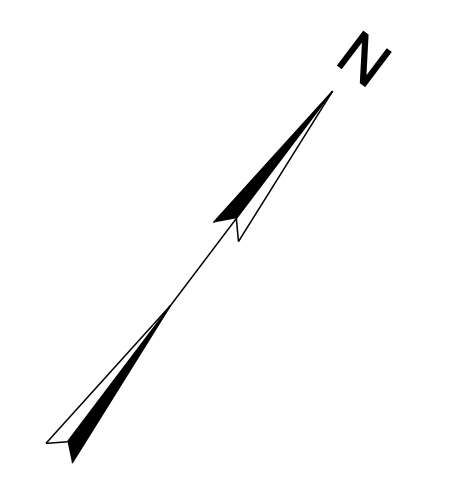
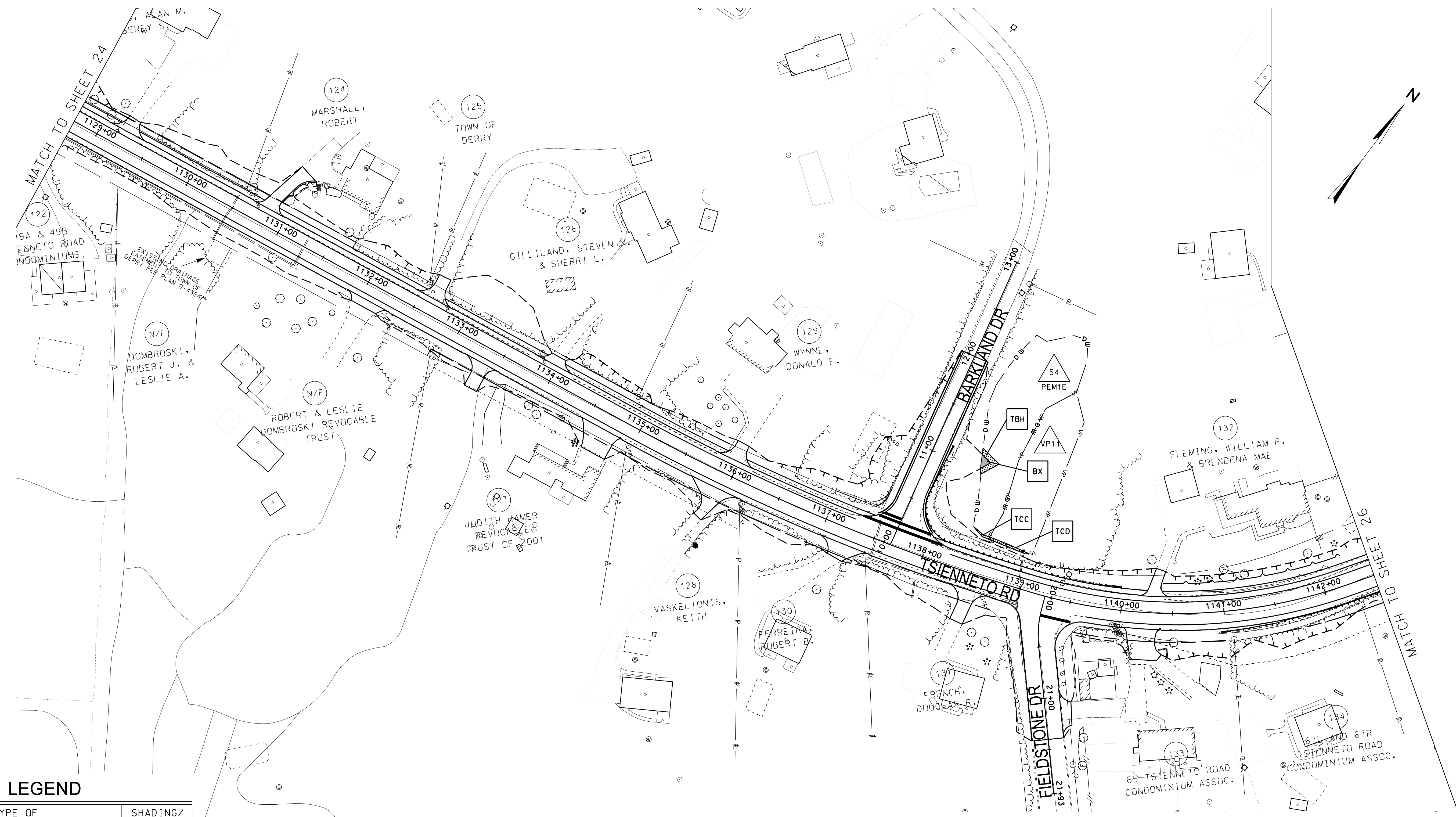

LEGEND

TYPE OF WETLAND IMPACT	SHADING/HATCHING
WETLANDS - NEW HAMPSHIRE WETLANDS BUREAU & ARMY CORP OF ENGINEERS (PERMANENT WETLAND)	
VERNAL POOL - NEW HAMPSHIRE WETLANDS BUREAU & ARMY CORP OF ENGINEERS (PERMANENT WETLAND)	
NEW HAMPSHIRE WETLANDS BUREAU & ARMY CORP OF ENGINEERS (TEMPORARY WETLAND)	

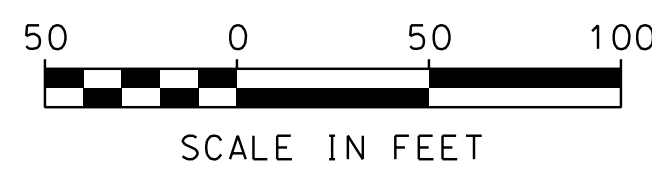

STATE OF NEW HAMPSHIRE			
DEPARTMENT OF TRANSPORTATION • BUREAU OF HIGHWAY DESIGN			
WETLAND IMPACT PLAN			
DGN	STATE PROJECT NO.	SHEET NO.	TOTAL SHEETS
13065WETL	13065	25	28

LEGEND

TYPE OF WETLAND IMPACT	SHADING/HATCHING
WETLANDS - NEW HAMPSHIRE WETLANDS BUREAU & ARMY CORP OF ENGINEERS (PERMANENT WETLAND)	
VERNAL POOL - NEW HAMPSHIRE WETLANDS BUREAU & ARMY CORP OF ENGINEERS (PERMANENT WETLAND)	
NEW HAMPSHIRE WETLANDS BUREAU & ARMY CORP OF ENGINEERS (TEMPORARY WETLAND)	

REVISIONS AFTER PROPOSAL	STATION	DESCRIPTION

NUMBER	DATE	STATION	DESCRIPTION

SDR PROCESSED	DATE	2/6/2020
NEW DESIGN	EMM	
SHEET CHECKED	NCF	
AS BUILT DETAILS	DATE	



STATE OF NEW HAMPSHIRE			
DEPARTMENT OF TRANSPORTATION • BUREAU OF HIGHWAY DESIGN			
WETLAND IMPACT PLAN			
DGN	STATE PROJECT NO.	SHEET NO.	TOTAL SHEETS
13065WETL	13065	26	28

SDR PROCESSED	DATE	2/6/2020
NEW DESIGN	DATE	2/6/2020
SHEET CHECKED	DATE	2/6/2020
AS BUILT DETAILS	DATE	

REVISIONS AFTER PROPOSAL	DESCRIPTION	STATION

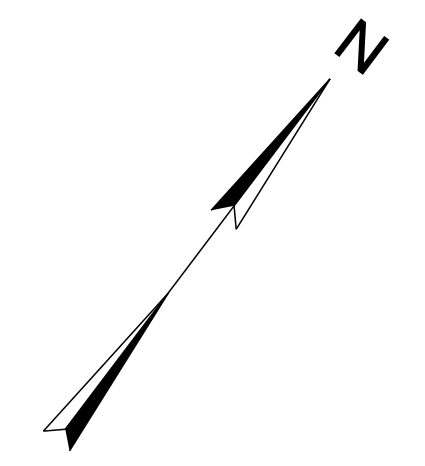
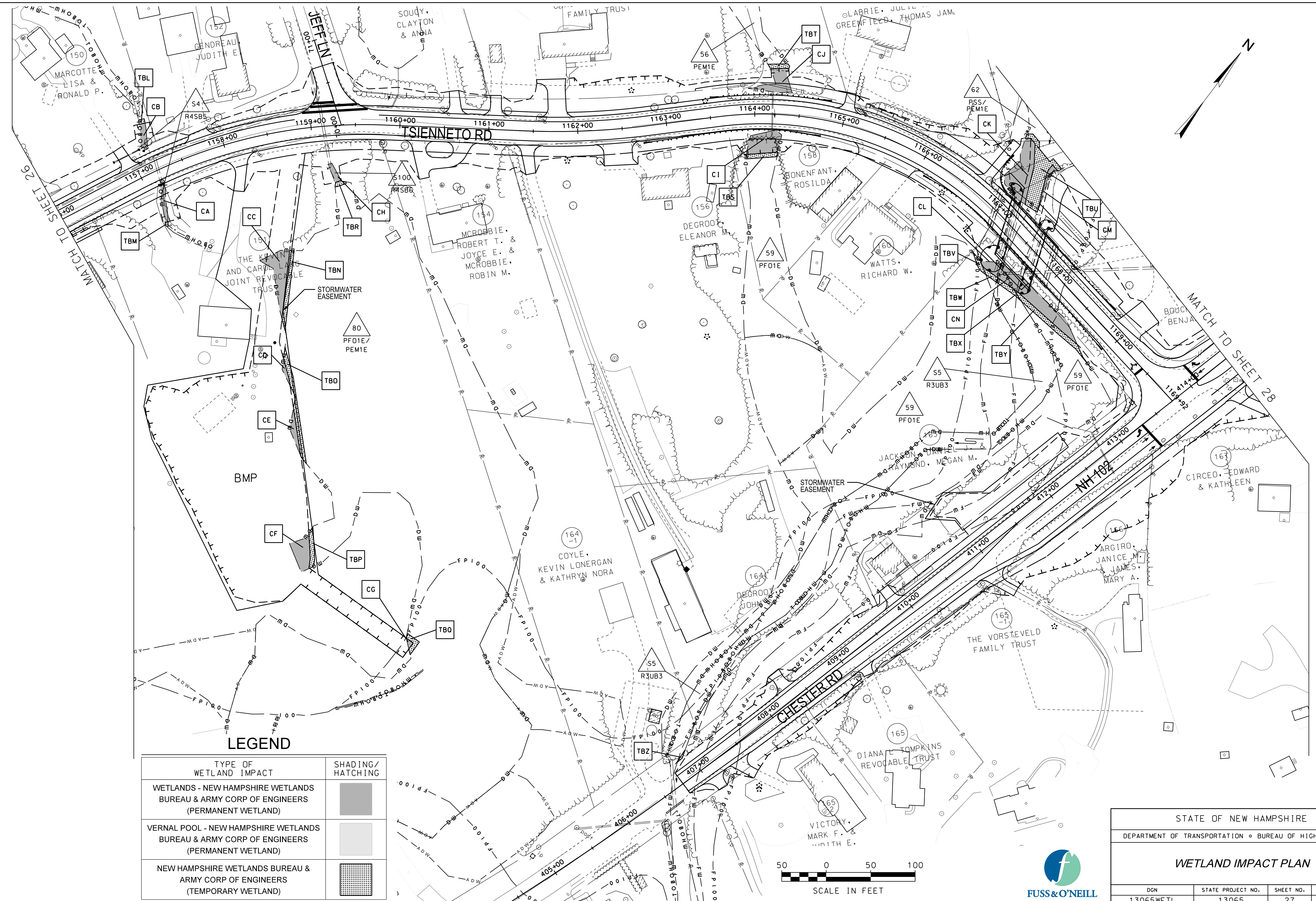

LEGEND

TYPE OF WETLAND IMPACT	SHADING/HATCHING
WETLANDS - NEW HAMPSHIRE WETLANDS BUREAU & ARMY CORP OF ENGINEERS (PERMANENT WETLAND)	
VERNAL POOL - NEW HAMPSHIRE WETLANDS BUREAU & ARMY CORP OF ENGINEERS (PERMANENT WETLAND)	
NEW HAMPSHIRE WETLANDS BUREAU & ARMY CORP OF ENGINEERS (TEMPORARY WETLAND)	



STATE OF NEW HAMPSHIRE			
DEPARTMENT OF TRANSPORTATION • BUREAU OF HIGHWAY DESIGN			
WETLAND IMPACT PLAN			
DGN 13065WETL	STATE PROJECT NO. 13065	SHEET NO. 27	TOTAL SHEETS 28

SDR PROCESSED	DATE	2/6/2020
NEW DESIGN	DATE	2/6/2020
SHEET CHECKED	DATE	2/6/2020
AS BUILT DETAILS	DATE	

REVISIONS AFTER PROPOSAL	STATION	DESCRIPTION

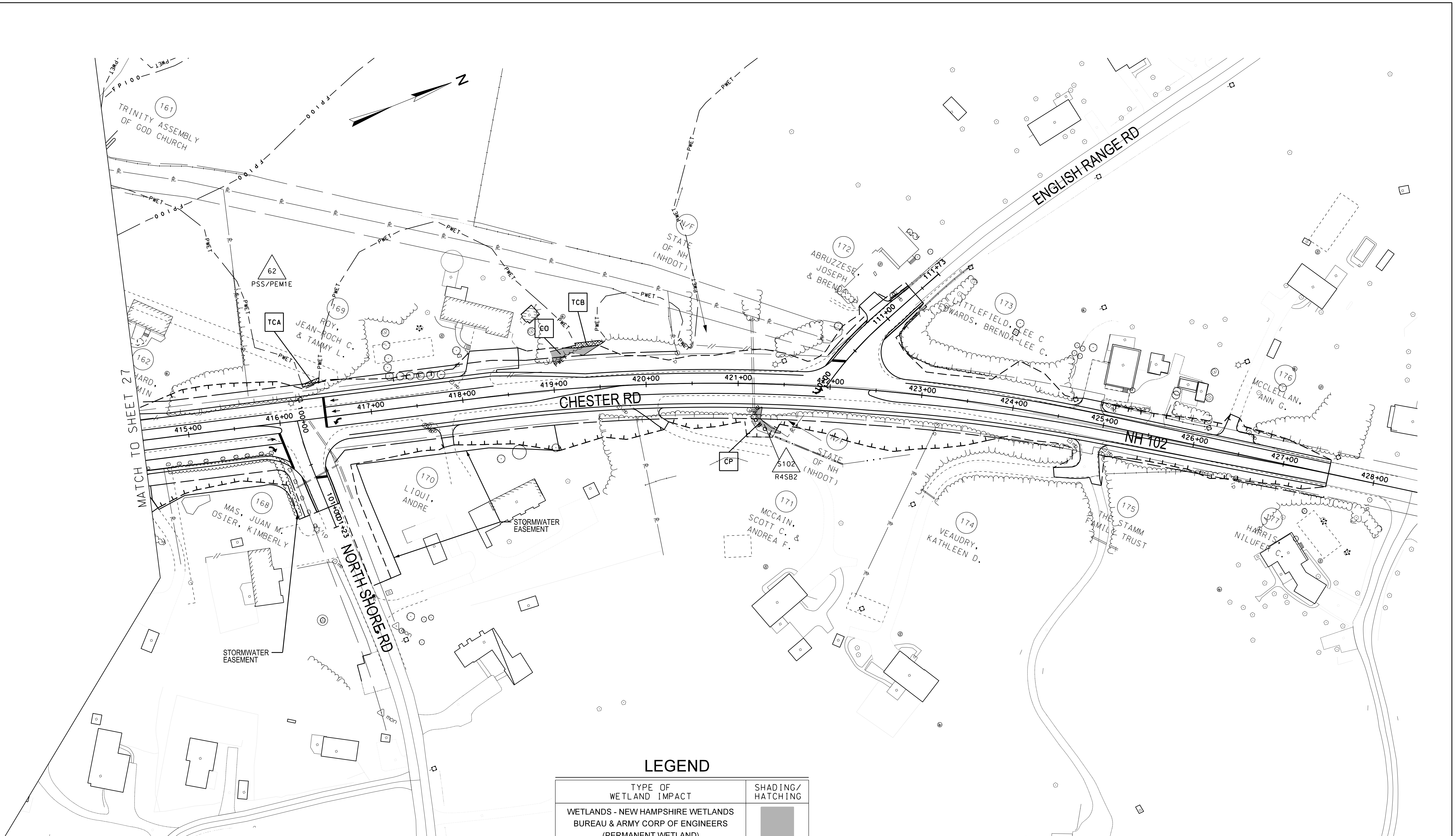

LEGEND

TYPE OF WETLAND IMPACT	SHADING/HATCHING
WETLANDS - NEW HAMPSHIRE WETLANDS BUREAU & ARMY CORP OF ENGINEERS (PERMANENT WETLAND)	
VERNAL POOL - NEW HAMPSHIRE WETLANDS BUREAU & ARMY CORP OF ENGINEERS (PERMANENT WETLAND)	
NEW HAMPSHIRE WETLANDS BUREAU & ARMY CORP OF ENGINEERS (TEMPORARY WETLAND)	



STATE OF NEW HAMPSHIRE			
DEPARTMENT OF TRANSPORTATION • BUREAU OF HIGHWAY DESIGN			
WETLAND IMPACT PLAN			
DGN	STATE PROJECT NO.	SHEET NO.	TOTAL SHEETS
13065WETL	13065	28	28

STATE OF NEW HAMPSHIRE
DEPARTMENT OF TRANSPORTATION

EROSION & SEDIMENT CONTROL PLANS
I-93 EXIT 4A DERRY-LONDONDERRY
FEDERAL PROJECT IM-0931(201)
NH PROJECT 13065

13065

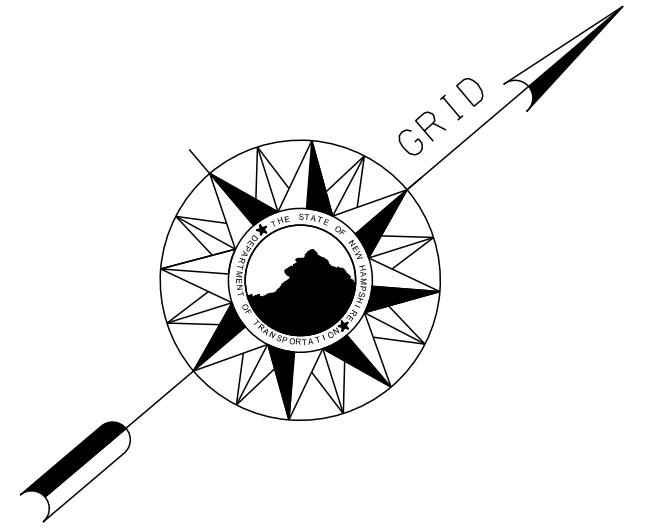
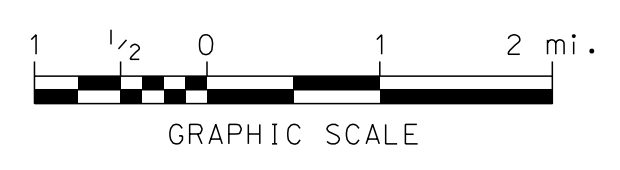
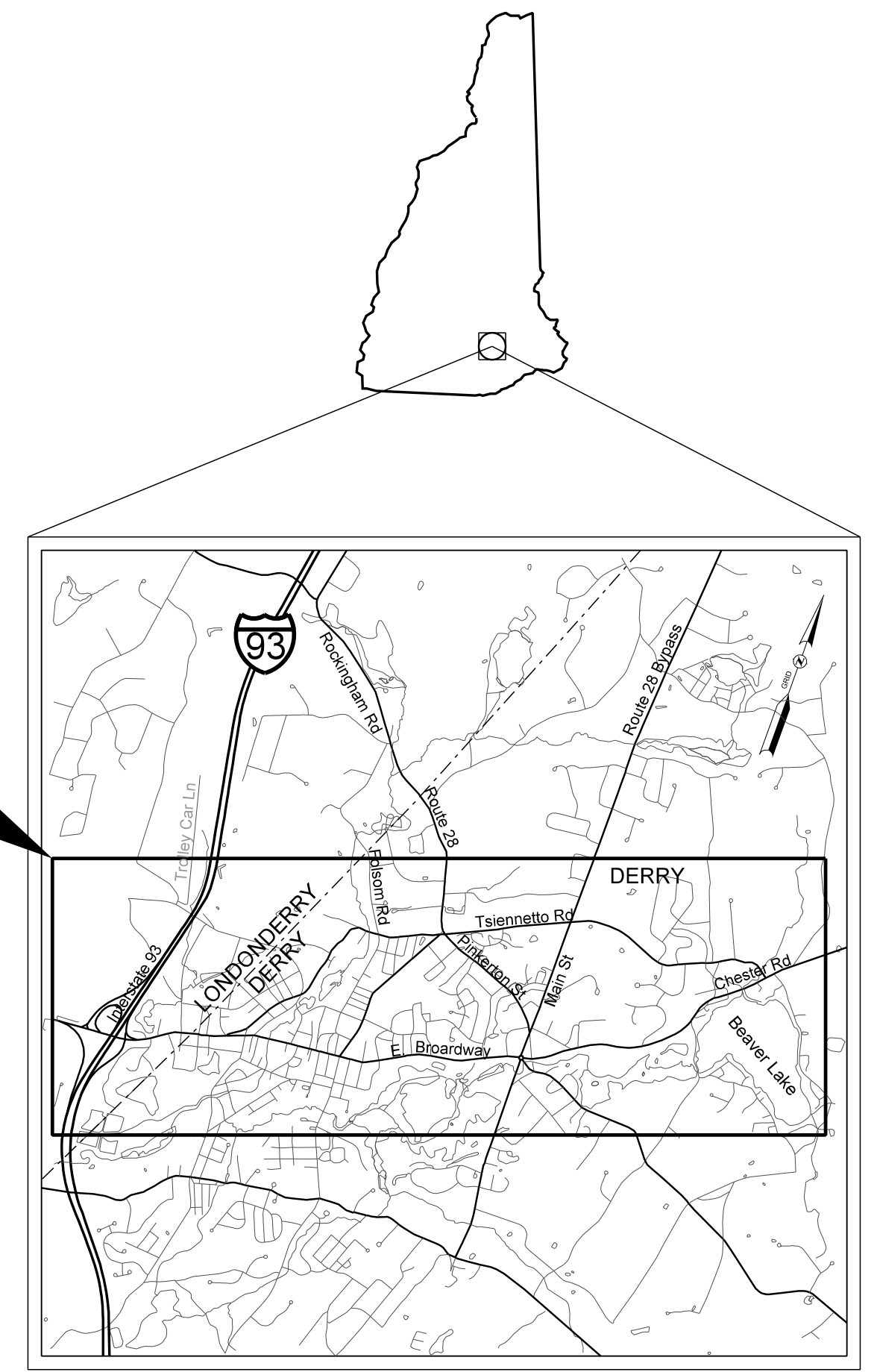

NOTES:

- CONTACT NHFG IMMEDIATELY IF STATE THREATENED OR ENDANGERED SPECIES ARE ENCOUNTERED DURING SITE SURVEYS OR DURING PROJECT CONSTRUCTION. MELISSA DOPERASKI OF 603-479-1129 OR NHFG WILDLIFE ADMINISTRATION AT 603-271-2461. PHOTOGRAPHS OF ANIMALS SHOULD BE TAKEN IF FEASIBLE TO HELP IN IDENTIFICATION.
- ALL EROSION CONTROL MATERIALS SHALL BE WILDLIFE-FRIENDLY, MADE FROM NATURAL WOVEN FIBERS (NO PLASTIC MESH PRODUCTS) WITHOUT FIXED KNOTS AND WITHOUT WELDED PLASTIC COMPONENTS.
- IF THE SPECIES NUTTALL'S REED GRASS (CALAMGROSTIS CINNOIDES), OR ANY OTHER LISTED SPECIES, IS IDENTIFIED WITHIN THE PROJECT AREA, COMPLETE A RARE SPECIES REPORTING FORM AND DOCUMENT THE POPULATION USING GPS. THEN CONTACT NHB. IF PLANTS ARE FOUND WITHIN THE PROJECT AREA BUT OUTSIDE OF IMPACTED AREAS, CONTACT NHB TO DISCUSS WHETHER INSTALLATION OF PROTECTIVE ORANGE FENCING DURING CONSTRUCTION MAY BE WARRANTED.
- REFER TO PROJECT PERMITS AND FEIS FOR ADDITIONAL REQUIREMENTS.

TOWNS OF LONDONDERRY & DERRY
COUNTY OF ROCKINGHAM
SCALE : 1" = 1000'



Kristen Hayden
04/30/2020



DATE 2/6/2020
DRAWN BY MGS
CHECKED BY KAH
DATE 2/6/2020

NH DOT THE STATE OF NEW HAMPSHIRE DEPARTMENT OF TRANSPORTATION			
RECOMMENDED FOR APPROVAL:			
_____ DIRECTOR OF PROJECT DEVELOPMENT		_____ DATE	
APPROVED:			
_____ ASSISTANT COMMISSIONER AND CHIEF ENGINEER		_____ DATE	
U. S. DEPARTMENT OF TRANSPORTATION FEDERAL HIGHWAY ADMINISTRATION			
APPROVED:			
_____ DIVISION ADMINISTRATOR		_____ DATE	
FEDERAL PROJECT NO.	STATE PROJECT NO.	SHEET NO.	TOTAL SHEETS
IM-0931(201)	13065	1	28

GENERAL

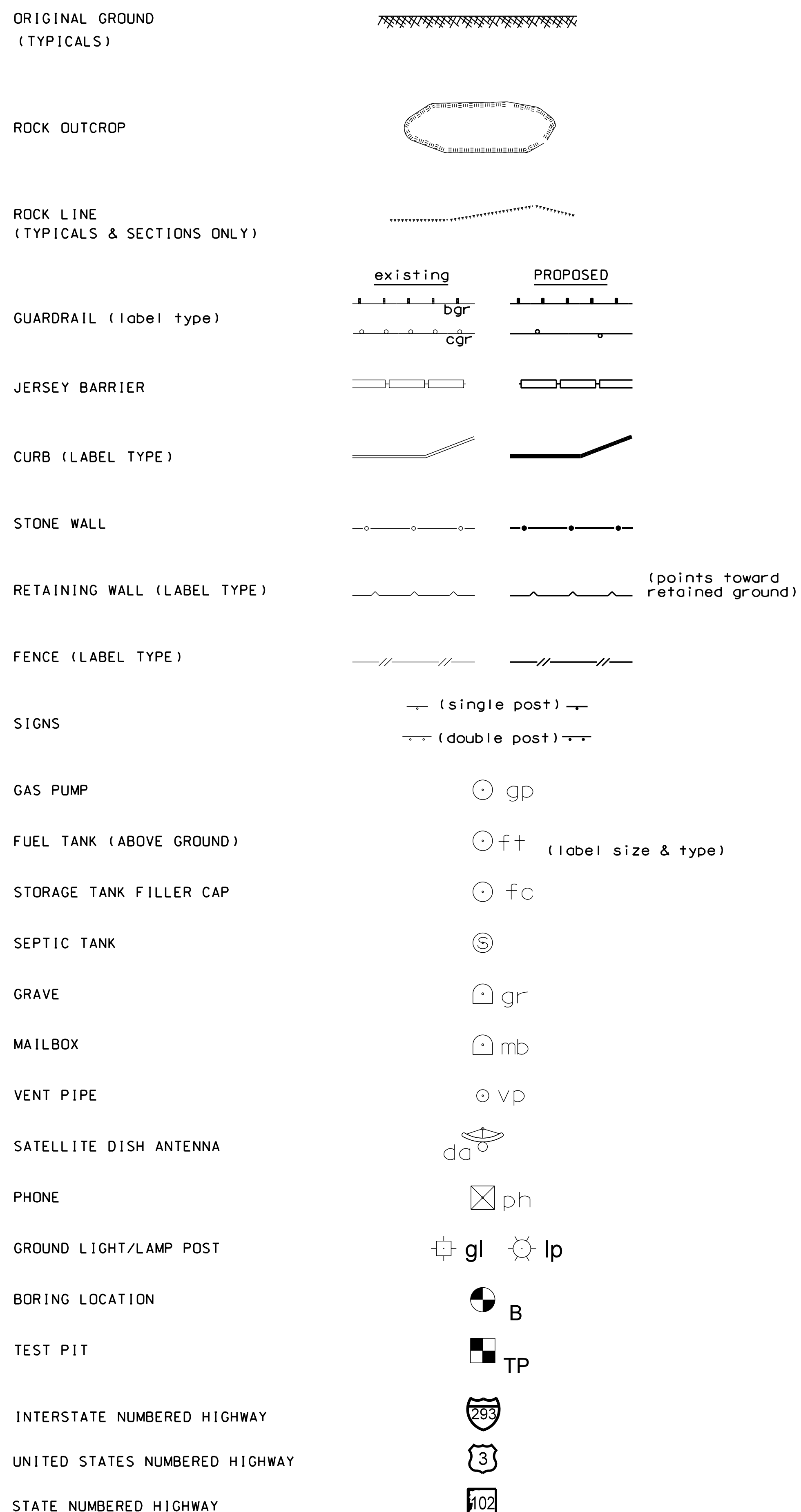
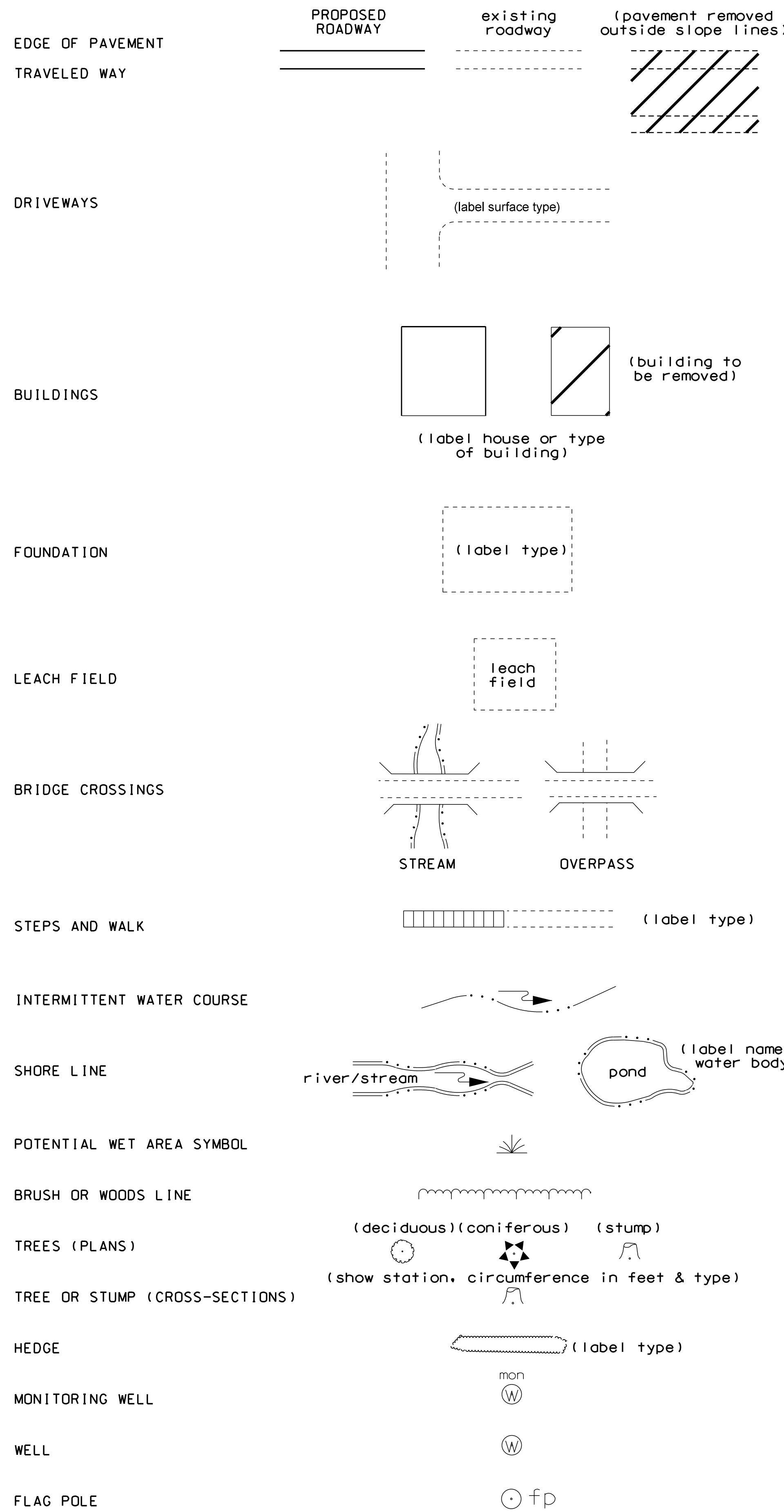

SHORELAND - WETLAND

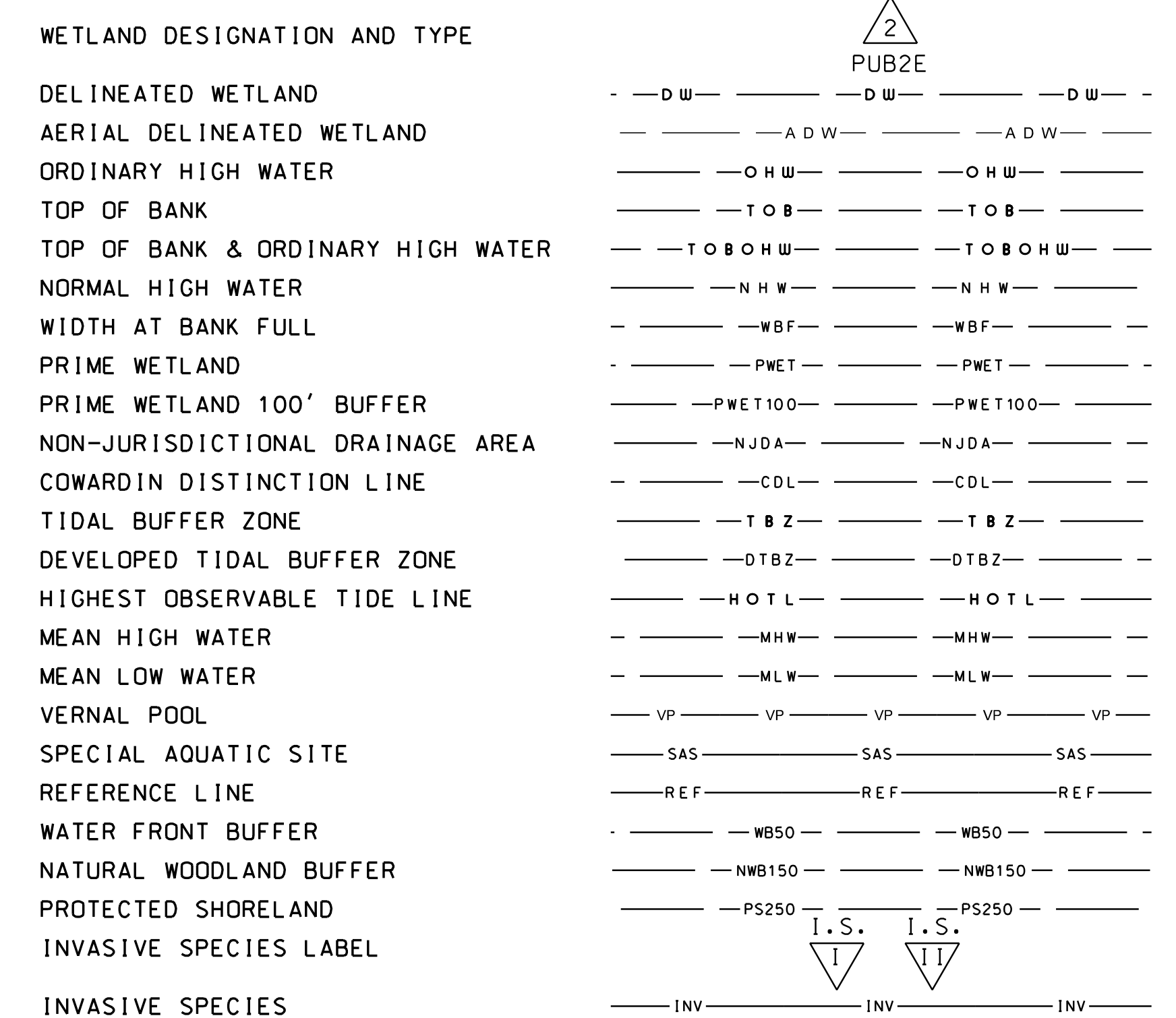

FLOODPLAIN / FLOODWAY

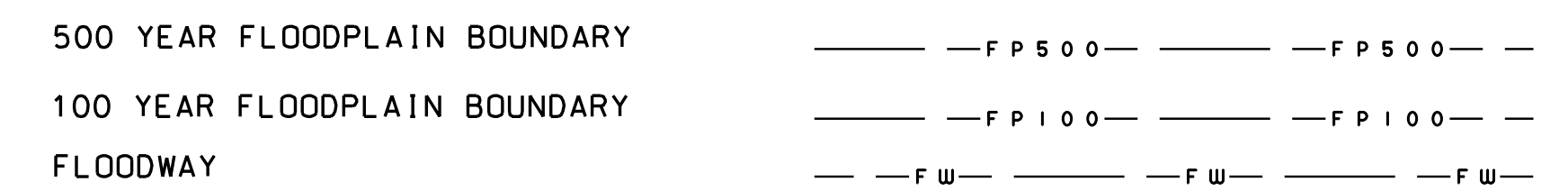

ENGINEERING

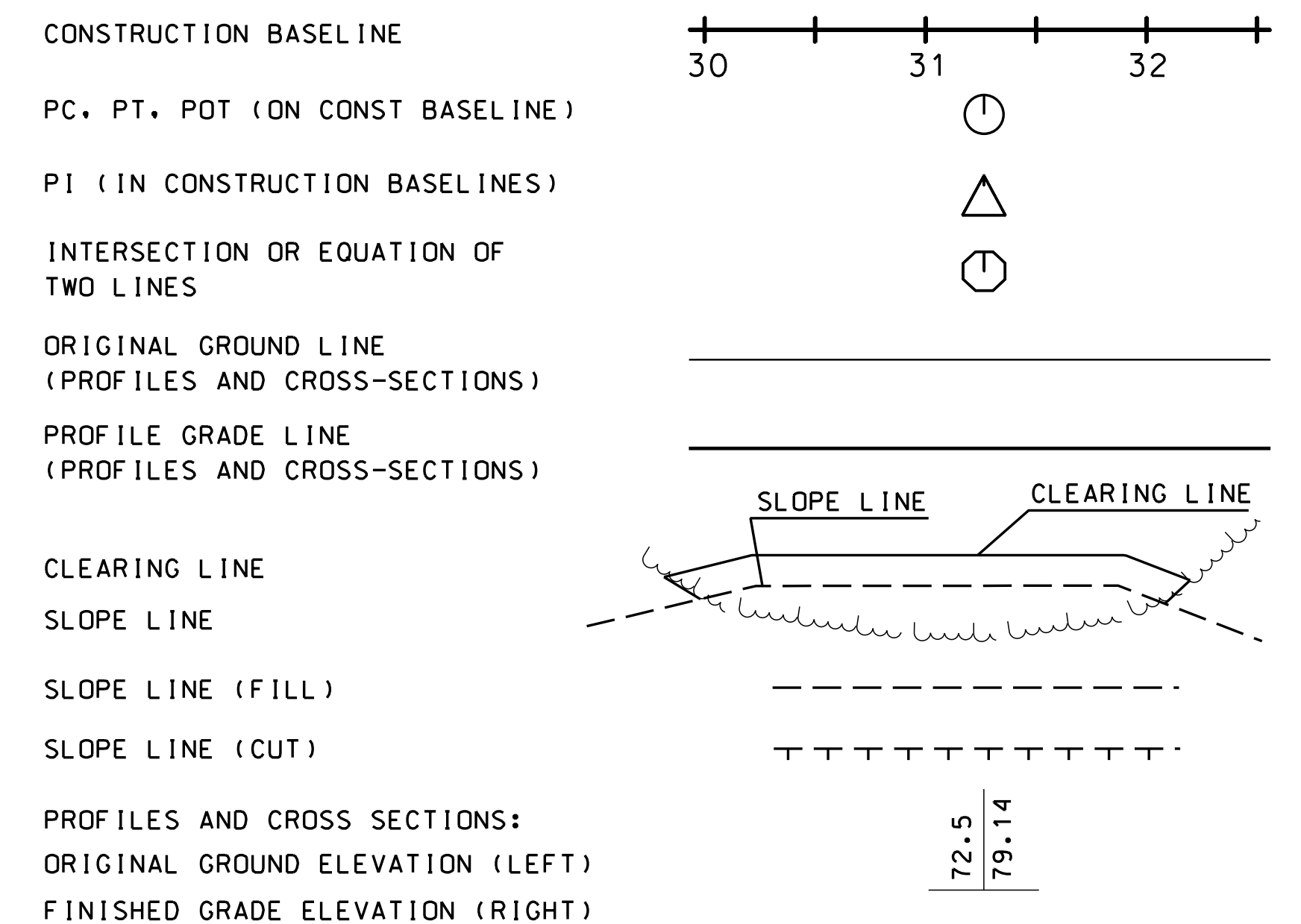

SHEET 1 OF 2

STATE OF NEW HAMPSHIRE
 DEPARTMENT OF TRANSPORTATION • BUREAU OF HIGHWAY DESIGN
STANDARD SYMBOLS

REVISION DATE	DGN	STATE PROJECT NO.	SHEET NO.	TOTAL SHEETS
11-21-2014	13065STDSYM	13065	2	28

DRAINAGE

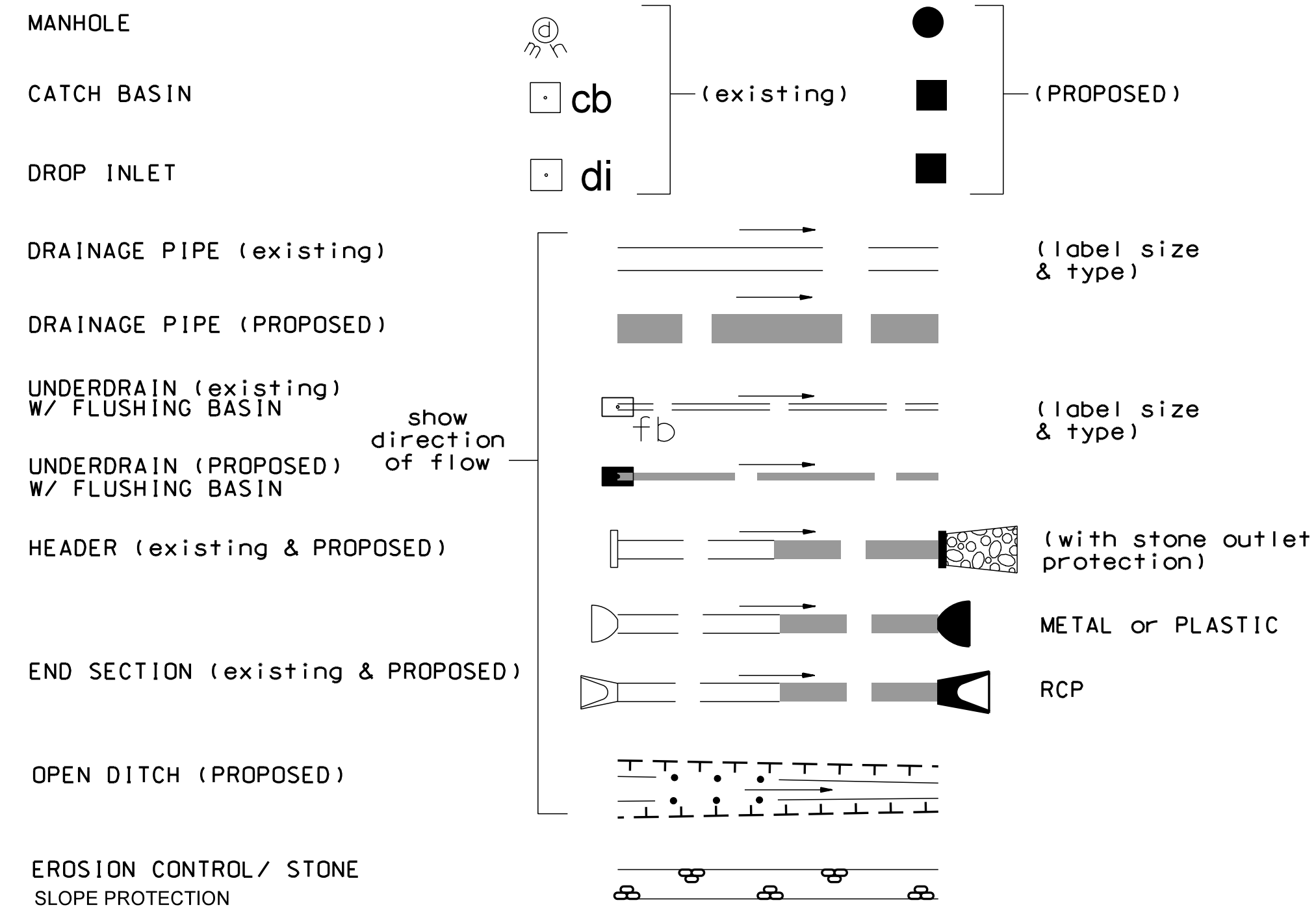

BOUNDARIES / RIGHT-OF-WAY

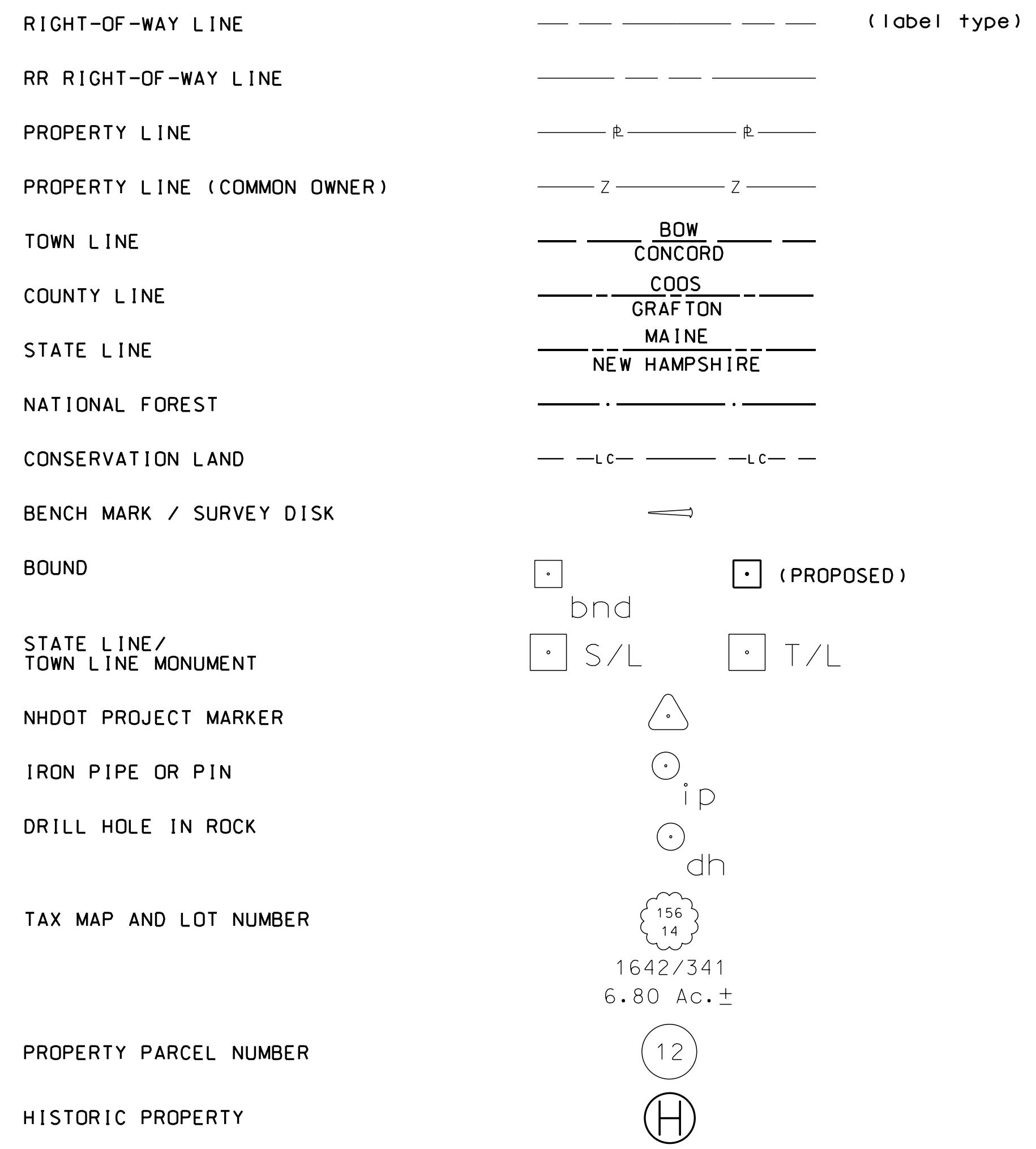

UTILITIES

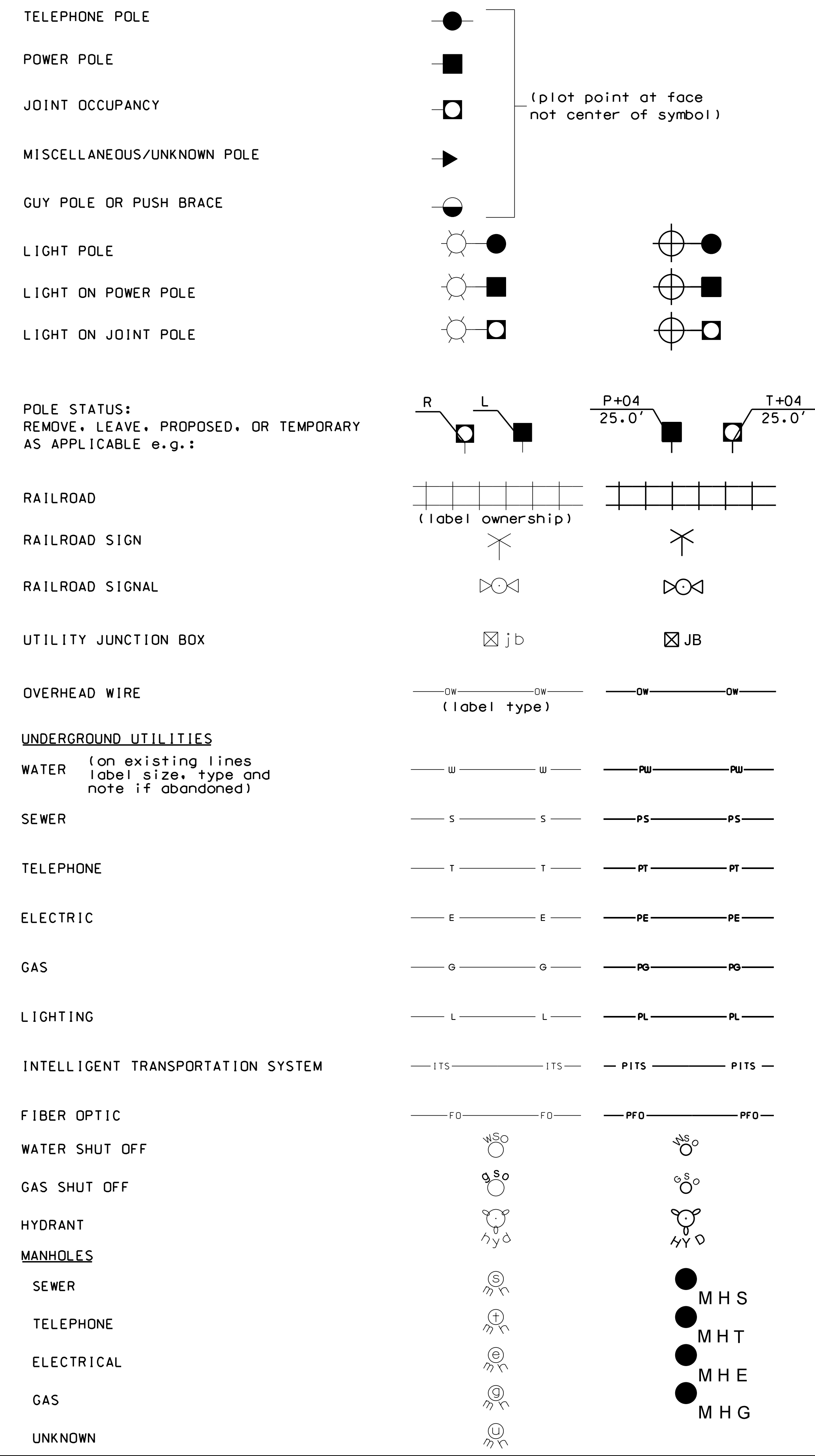

TRAFFIC SIGNALS / ITS

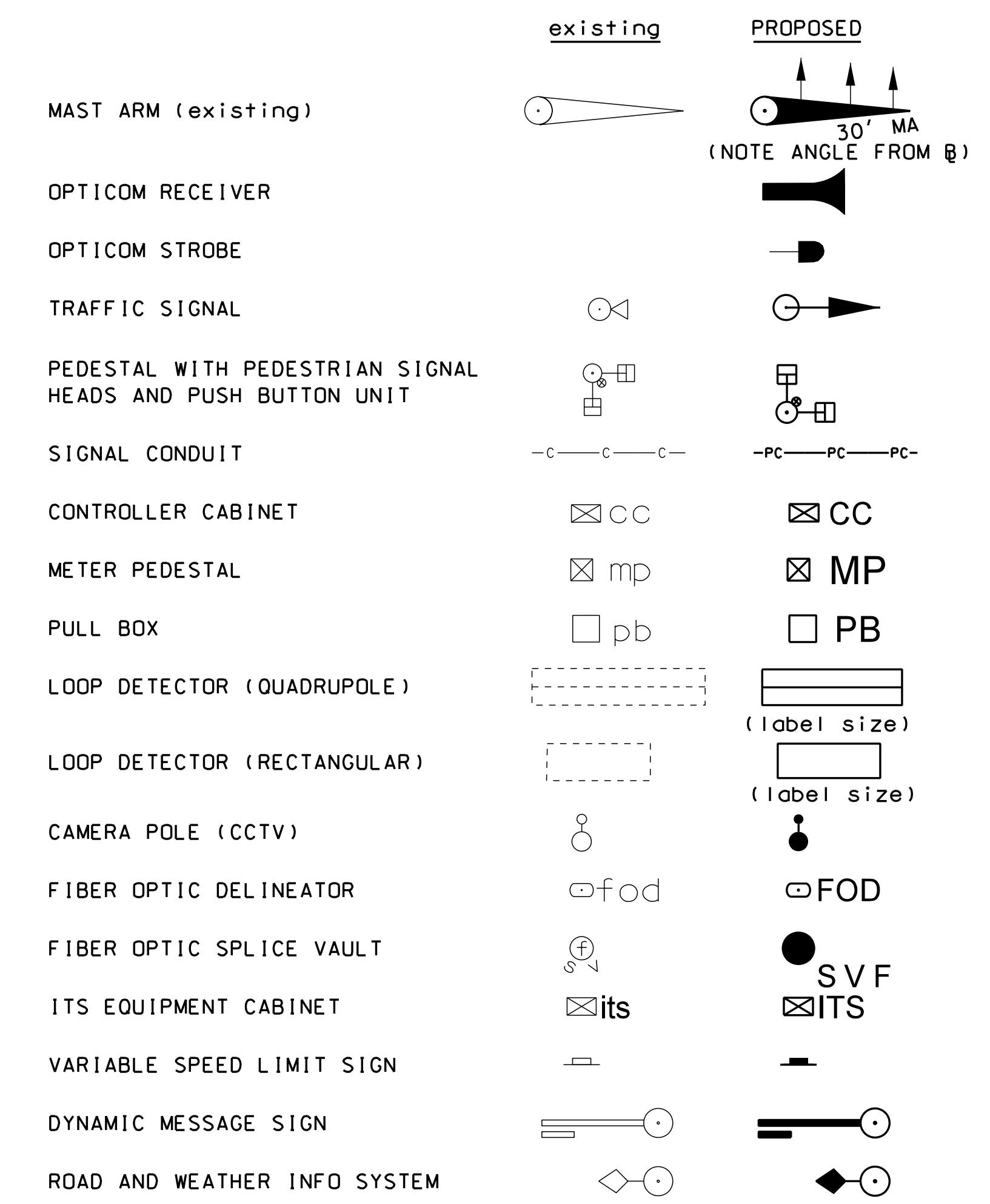

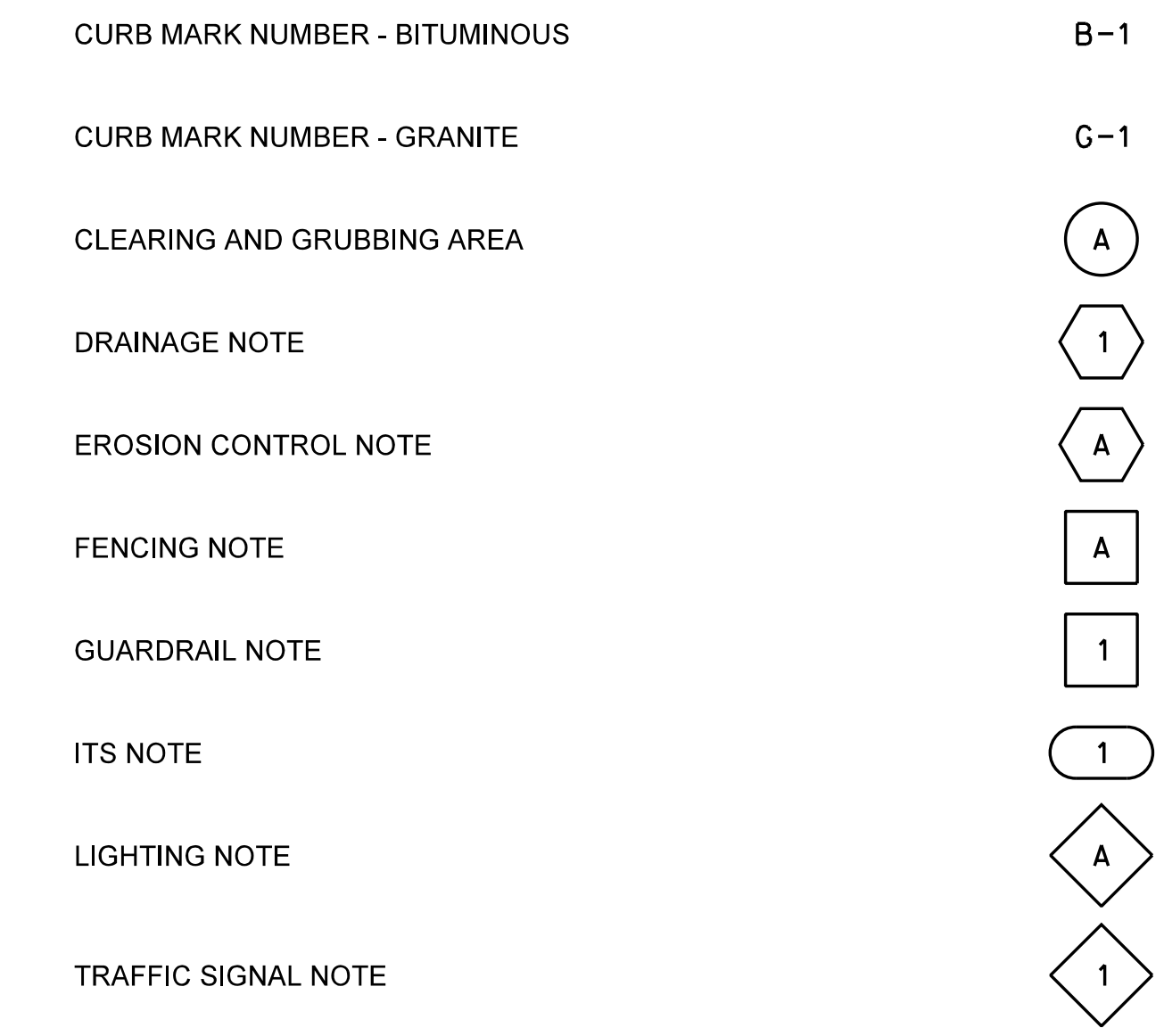

CONSTRUCTION NOTES



SHEET 2 OF 2

STATE OF NEW HAMPSHIRE				
DEPARTMENT OF TRANSPORTATION • BUREAU OF HIGHWAY DESIGN				
STANDARD SYMBOLS				
REVISION DATE	DGN	STATE PROJECT NO.	SHEET NO.	TOTAL SHEETS
9-1-2016	13065STDSYM	13065	3	28

EROSION CONTROL PLAN LEGEND

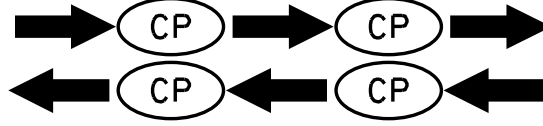
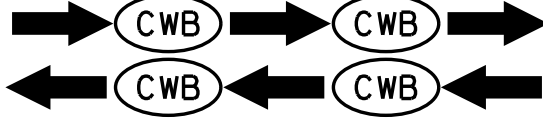
<p><u>PERIMETER CONTROL</u> SILT FENCE EROSION CONTROL MIX BERM EROSION CONTROL MIX SOX TURBIDITY CURTAIN SHEET PILE COFFER DAM</p>	
<p><u>NATURAL BUFFER/PERIMETER CONTROL</u> SILT FENCE EROSION CONTROL MIX BERM EROSION CONTROL MIX SOX TURBIDITY CURTAIN SHEET PILE COFFER DAM</p>	
<p><u>CHANNEL PROTECTION</u> STONE CHECK DAMS STRAW WATTLES CHANNEL MATTING CLASS D EROSION STONE CLASS C STONE</p>	
<p><u>CLEAN WATER BYPASS</u> PUMP THROUGH PIPE DRAIN THROUGH PIPE OR CHANNEL</p>	

STATE OF NEW HAMPSHIRE				
DEPARTMENT OF TRANSPORTATION • BUREAU OF HIGHWAY DESIGN				
<i>EROSION CONTROL SYMBOLS</i>				
REVISION DATE	DGN	STATE PROJECT NO.	SHEET NO.	TOTAL SHEETS
1-17-2020	13065STD SYMERO	13065	4	28

EROSION CONTROL STRATEGIES

1. ENVIRONMENTAL COMMITMENTS:
 - 1.1. THESE GUIDELINES DO NOT RELIEVE THE CONTRACTOR FROM COMPLIANCE WITH ANY CONTRACT PROVISIONS, OR APPLICABLE FEDERAL, STATE, AND LOCAL REGULATIONS.
 - 1.2. THIS PROJECT WILL BE SUBJECT TO THE US EPA'S NATIONAL POLLUTANT DISCHARGE ELIMINATION SYSTEM (NPDES) STORM WATER CONSTRUCTION GENERAL PERMIT AS ADMINISTERED BY THE ENVIRONMENTAL PROTECTION AGENCY (EPA). THIS PROJECT IS SUBJECT TO REQUIREMENTS IN THE MOST RECENT CONSTRUCTION GENERAL PERMIT (CGP).
 - 1.3. THE CONTRACTOR'S ATTENTION IS DIRECTED TO THE NHDES WETLAND PERMIT, THE US ARMY CORPS OF ENGINEERS PERMIT, WATER QUALITY CERTIFICATION AND THE SPECIAL ATTENTION ITEMS INCLUDED IN THE CONTRACT DOCUMENTS.
 - 1.4. ALL STORM WATER, EROSION AND SEDIMENT CONTROL MEASURES SHALL BE INSTALLED AND MAINTAINED IN ACCORDANCE WITH THE NEW HAMPSHIRE STORMWATER MANUAL, VOLUME 3, EROSION AND SEDIMENT CONTROLS DURING CONSTRUCTION (DECEMBER 2008) (BMP MANUAL) AVAILABLE FROM THE NEW HAMPSHIRE DEPARTMENT OF ENVIRONMENTAL SERVICES (NHDES).
 - 1.5. THE CONTRACTOR SHALL COMPLY WITH RSA 485-A:17, AND ALL, PUBLISHED NHDES ALTERATION OF TERRAIN ENV-WO 1500 REQUIREMENTS ([HTTP://DES.NH.GOV/ORGANIZATION/COMMISSIONER/LEGAL/RULES/INDEX.HTM](http://des.nh.gov/organization/commissioner/legal/rules/index.htm))
 - 1.6. THE CONTRACTOR IS DIRECTED TO REVIEW AND COMPLY WITH SECTION 107.1 OF THE CONTRACT AS IT REFERS TO SPILLAGE, AND ALSO WITH REGARDS TO EROSION, POLLUTION, AND TURBIDITY PRECAUTIONS.
 2. STANDARD EROSION CONTROL SEQUENCING APPLICABLE TO ALL CONSTRUCTION PROJECTS:
 - 2.1. PERIMETER CONTROLS SHALL BE INSTALLED PRIOR TO EARTH DISTURBING ACTIVITIES. PERIMETER CONTROLS AND STABILIZED CONSTRUCTION EXITS SHALL BE INSTALLED AS SHOWN IN THE BMP MANUAL AND AS DIRECTED BY THE STORMWATER POLLUTION PREVENTION PLAN (SWPPP) PREPARER.
 - 2.2. EROSION, SEDIMENTATION CONTROL MEASURES AND INFILTRATION BASINS SHALL BE CLEANED, REPLACED AND AUGMENTED AS NECESSARY TO PREVENT SEDIMENTATION BEYOND PROJECT LIMITS THROUGHOUT THE PROJECT DURATION.
 - 2.3. EROSION AND SEDIMENT CONTROL MEASURES SHALL BE INSPECTED IN ACCORDANCE WITH THE CONSTRUCTION GENERAL PERMIT AND SECTION 645 OF THE NHDOT SPECIFICATIONS FOR ROAD AND BRIDGES CONSTRUCTION.
 - 2.4. AN AREA SHALL BE CONSIDERED STABLE IF ONE OF THE FOLLOWING HAS OCCURRED:
 - (A) BASE COURSE GRAVELS HAVE BEEN INSTALLED IN AREAS TO BE PAVED;
 - (B) A MINIMUM OF 85% VEGETATED GROWTH HAS BEEN ESTABLISHED;
 - (C) A MINIMUM OF 3" OF NON-EROSIVE MATERIAL SUCH AS STONE OR RIP-RAP HAS BEEN INSTALLED;
 - (D) TEMPORARY SLOPE STABILIZATION CONFORMING TO TABLE 1 HAS BEEN PROPERLY INSTALLED
 - 2.5. ALL STOCKPILES SHALL BE CONTAINED WITH A PERIMETER CONTROL. IF THE STOCKPILE IS TO REMAIN UNDISTURBED FOR MORE THAN 14 DAYS, MULCHING WILL BE REQUIRED.
 - 2.6. A WATER TRUCK SHALL BE AVAILABLE TO CONTROL EXCESSIVE DUST AT THE DIRECTION OF THE CONTRACT ADMINISTRATOR.
 - 2.7. TEMPORARY EROSION AND SEDIMENTATION CONTROL MEASURES SHALL REMAIN UNTIL THE AREA HAS BEEN PERMANENTLY STABILIZED.
 - 2.8. CONSTRUCTION PERFORMED ANY TIME BETWEEN NOVEMBER 30th AND MAY 1st OF ANY YEAR SHALL BE CONSIDERED WINTER CONSTRUCTION AND SHALL CONFORM TO THE FOLLOWING REQUIREMENTS.
 - (A) ALL PROPOSED VEGETATED AREAS WHICH DO NOT EXHIBIT A MINIMUM OF 85% VEGETATIVE GROWTH BY OCTOBER 15th, OR WHICH ARE DISTURBED AFTER OCTOBER 15th, SHALL BE STABILIZED IN ACCORDANCE WITH TABLE 1.
 - (B) ALL DITCHES OR SWALES WHICH DO NOT EXHIBIT A MINIMUM OF 85% VEGETATIVE GROWTH BY OCTOBER 15th, OR WHICH ARE DISTURBED AFTER OCTOBER 15th, SHALL BE STABILIZED TEMPORARILY WITH STONE OR IN ACCORDANCE WITH TABLE 1.
 - (C) AFTER NOVEMBER 30th INCOMPLETE ROAD SURFACES, WHERE WORK HAS STOPPED FOR THE SEASON, SHALL BE PROTECTED IN ACCORDANCE WITH TABLE 1.
 - (D) WINTER EXCAVATION AND EARTHWORK SHALL BE DONE SUCH THAT NO MORE THAN 1 ACRE OF THE PROJECT IS WITHOUT STABILIZATION AT ONE TIME, UNLESS A WINTER CONSTRUCTION PLAN HAS BEEN APPROVED BY NHDOT THAT MEETS THE REQUIREMENTS OF ENV-WO 1505.02 AND ENV-WO 1505.05.
 - (E) A SWPPP AMENDMENT SHALL BE SUBMITTED TO THE DEPARTMENT, FOR APPROVAL, ADDRESSING COLD WEATHER STABILIZATION (ENV-WO 1505.05) AND INCLUDING THE REQUIREMENTS OF NO LESS THAN 30 DAYS PRIOR TO THE COMMENCEMENT OF WORK SCHEDULED AFTER NOVEMBER 30th.
- GENERAL CONSTRUCTION PLANNING AND SELECTION OF STRATEGIES TO CONTROL EROSION AND SEDIMENT ON HIGHWAY CONSTRUCTION PROJECTS
3. PLAN ACTIVITIES TO ACCOUNT FOR SENSITIVE SITE CONDITIONS:
 - 3.1. CLEARLY FLAG AREAS TO BE PROTECTED IN THE FIELD AND PROVIDE CONSTRUCTION BARRIERS TO PREVENT TRAFFICKING OUTSIDE OF WORK AREAS.
 - 3.2. CONSTRUCTION SHALL BE SEQUENCED TO LIMIT THE DURATION AND AREA OF EXPOSED SOILS.
 - 3.3. PROTECT AND MAXIMIZE EXISTING NATIVE VEGETATION AND NATURAL FOREST BUFFERS BETWEEN CONSTRUCTION ACTIVITY AND SENSITIVE AREAS.
 - 3.4. WHEN WORK IS PERFORMED IN AND NEAR WATER COURSES, STREAM FLOW DIVERSION METHODS SHALL BE IMPLEMENTED PRIOR TO ANY EXCAVATION OR FILLING.
 - 3.5. WHEN WORK IS PERFORMED WITHIN 50 FEET OF SURFACE WATERS (WETLAND, OPEN WATER OR FLOWING WATER), PERIMETER CONTROL SHALL BE ENHANCED CONSISTENT WITH SECTION 2.1.2.1. OF THE 2012 NPDES CONSTRUCTION GENERAL PERMIT.
 4. MINIMIZE THE AMOUNT OF EXPOSED SOIL:
 - 4.1. CONSTRUCTION SHALL BE SEQUENCED TO LIMIT THE DURATION AND AREA OF EXPOSED SOILS. MINIMIZE THE AREA OF EXPOSED SOIL AT ANY ONE TIME. PHASING SHALL BE USED TO REDUCE THE AMOUNT AND DURATION OF SOIL EXPOSED TO THE ELEMENTS AND VEHICLE TRACKING.
 - 4.2. UTILIZE TEMPORARY MULCHING OR PROVIDE ALTERNATE TEMPORARY STABILIZATION ON EXPOSED SOILS IN ACCORDANCE WITH TABLE 1.
 - 4.3. THE MAXIMUM AMOUNT OF DISTURBED EARTH SHALL NOT EXCEED A TOTAL OF 5 ACRES FROM MAY 1st THROUGH NOVEMBER 30th, OR EXCEED ONE ACRE DURING WINTER MONTHS, UNLESS THE CONTRACTOR DEMONSTRATES TO THE DEPARTMENT THAT THE ADDITIONAL AREA OF DISTURBANCE IS NECESSARY TO MEET THE CONTRACTORS CRITICAL PATH METHOD SCHEDULE (CPM), AND THE CONTRACTOR HAS ADEQUATE RESOURCES AVAILABLE TO ENSURE THAT ENVIRONMENTAL COMMITMENTS WILL BE MET.
 5. CONTROL STORMWATER FLOWING ONTO AND THROUGH THE PROJECT:
 - 5.1. DIVERT OFF SITE RUNOFF OR CLEAN WATER AWAY FROM THE CONSTRUCTION ACTIVITY TO REDUCE THE VOLUME THAT NEEDS TO BE TREATED ON SITE.
 - 5.2. DIVERT STORM RUNOFF FROM UPSLOPE DRAINAGE AREAS AWAY FROM DISTURBED AREAS, SLOPES, AND AROUND ACTIVE WORK AREAS AND TO A STABILIZED OUTLET LOCATION.
 - 5.3. CONSTRUCT IMPERMEABLE BARRIERS AS NECESSARY TO COLLECT OR DIVERT CONCENTRATED FLOWS FROM WORK OR DISTURBED AREAS.
 - 5.4. STABILIZE, TO APPROPRIATE ANTICIPATED VELOCITIES, CONVEYANCE CHANNELS OR PUMPING SYSTEMS NEEDED TO CONVEY CONSTRUCTION STORMWATER TO BASINS AND DISCHARGE LOCATIONS PRIOR TO USE.
 - 5.5. DIVERT OFF-SITE WATER THROUGH THE PROJECT IN AN APPROPRIATE MANNER SO NOT TO DISTURB THE UPSTREAM OR DOWNSTREAM SOILS, VEGETATION OR HYDROLOGY BEYOND THE PERMITTED AREA.
 6. PROTECT SLOPES:
 - 6.1. INTERCEPT AND DIVERT STORM RUNOFF FROM UPSLOPE DRAINAGE AREAS AWAY FROM UNPROTECTED AND NEWLY ESTABLISHED AREAS AND SLOPES TO A STABILIZED OUTLET OR CONVEYANCE.
 - 6.2. CONSIDER HOW GROUNDWATER SEEPAGE ON CUT SLOPES MAY IMPACT SLOPE STABILITY AND INCORPORATE APPROPRIATE MEASURES TO MINIMIZE EROSION.
 - 6.3. CONVEY STORMWATER DOWN THE SLOPE IN A STABILIZED CHANNEL OR SLOPE DRAIN.
 - 6.4. THE OUTER FACE OF THE FILL SLOPE SHOULD BE IN A LOOSE RUFFLED CONDITION PRIOR TO TURF ESTABLISHMENT. TOPSOIL OR HUMUS LAYERS SHALL BE TRACKED UP AND DOWN THE SLOPE, DISKED, HARROWED, DRAGGED WITH A CHAIN OR MAT, MACHINE-RAKED, OR HAND-WORKED TO PRODUCE A RUFFLED SURFACE.
 7. ESTABLISH STABILIZED CONSTRUCTION EXITS:
 - 7.1. INSTALL AND MAINTAIN CONSTRUCTION EXITS, ANYWHERE TRAFFIC LEAVES A CONSTRUCTION SITE ONTO A PUBLIC RIGHT-OF-WAY.
 - 7.2. SWEEP ALL CONSTRUCTION RELATED DEBRIS AND SOIL FROM THE ADJACENT PAVED ROADWAYS AS NECESSARY.
 8. PROTECT STORM DRAIN INLETS:
 - 8.1. DIVERT SEDIMENT LADEN WATER AWAY FROM INLET STRUCTURES TO THE EXTENT POSSIBLE.
 - 8.2. INSTALL SEDIMENT BARRIERS AND SEDIMENT TRAPS AT INLETS TO PREVENT SEDIMENT FROM ENTERING THE DRAINAGE SYSTEM.
 - 8.3. CLEAN CATCH BASINS, DRAINAGE PIPES, AND CULVERTS IF SIGNIFICANT SEDIMENT IS DEPOSITED.
 - 8.4. DROP INLET SEDIMENT BARRIERS SHOULD NEVER BE USED AS THE PRIMARY MEANS OF SEDIMENT CONTROL AND SHOULD ONLY BE USED TO PROVIDE AN ADDITIONAL LEVEL OF PROTECTION TO STRUCTURES AND DOWN-GRADIENT SENSITIVE RECEPTORS.
 9. SOIL STABILIZATION:
 - 9.1. WITHIN THREE DAYS OF THE LAST ACTIVITY IN AN AREA, ALL EXPOSED SOIL AREAS, WHERE CONSTRUCTION ACTIVITIES ARE COMPLETE, SHALL BE STABILIZED.
 - 9.2. IN ALL AREAS, TEMPORARY SOIL STABILIZATION MEASURES SHALL BE APPLIED IN ACCORDANCE WITH THE STABILIZATION REQUIREMENTS (SECTION 2.2) OF THE 2012 CGP. (SEE TABLE 1 FOR GUIDANCE ON THE SELECTION OF TEMPORARY SOIL STABILIZATION MEASURES.)
 - 9.3. EROSION CONTROL SEED MIX SHALL BE SOWN IN ALL INACTIVE CONSTRUCTION AREAS THAT WILL NOT BE PERMANENTLY SEEDED WITHIN TWO WEEKS OF DISTURBANCE AND PRIOR TO SEPTEMBER 15, OF ANY GIVEN YEAR, IN ORDER TO ACHIEVE VEGETATIVE STABILIZATION PRIOR TO THE END OF THE GROWING SEASON.
 - 9.4. SOIL TACKIFIERS MAY BE APPLIED IN ACCORDANCE WITH THE MANUFACTURER'S SPECIFICATIONS AND REAPPLIED AS NECESSARY TO MINIMIZE SOIL AND MULCH LOSS UNTIL PERMANENT VEGETATION IS ESTABLISHED.
 10. RETAIN SEDIMENT ON-SITE AND CONTROL DEWATERING PRACTICES:
 - 10.1. TEMPORARY SEDIMENT BASINS (CGP-SECTION 2.1.3.2) OR SEDIMENT TRAPS (ENV-WO 1506.10) SHALL BE SIZED TO RETAIN, ON SITE, THE VOLUME OF A 2-YEAR 24-HOUR STORM EVENT FOR ANY AREA OF DISTURBANCE OR 3,600 CUBIC FEET OF STORMWATER RUNOFF PER ACRE OF DISTURBANCE, WHICHEVER IS GREATER. TEMPORARY SEDIMENT BASINS USED TO TREAT STORMWATER RUNOFF FROM AREAS GREATER THAN 5-ACRES OF DISTURBANCE SHALL BE SIZED TO ALSO CONTROL STORMWATER RUNOFF FROM A 10-YEAR 24 HOUR STORM EVENT. ON-SITE RETENTION OF THE 10-YEAR 24-HOUR EVENT IS NOT REQUIRED.
 - 10.2. CONSTRUCT AND STABILIZE DEWATERING INFILTRATION BASINS PRIOR TO ANY EXCAVATION THAT MAY REQUIRE DEWATERING.
 - 10.3. TEMPORARY SEDIMENT BASINS OR TRAPS SHALL BE PLACED AND STABILIZED AT LOCATIONS WHERE CONCENTRATED FLOW (CHANNELS AND PIPES) DISCHARGE TO THE SURROUNDING ENVIRONMENT FROM AREAS OF UNSTABILIZED EARTH DISTURBING ACTIVITIES.

11. ADDITIONAL EROSION AND SEDIMENT CONTROL GENERAL PRACTICES:
 - 11.1. USE TEMPORARY MULCHING, PERMANENT MULCHING, TEMPORARY VEGETATIVE COVER, AND PERMANENT VEGETATIVE COVER TO REDUCE THE NEED FOR DUST CONTROL. USE MECHANICAL SWEEPERS ON PAVED SURFACES WHERE NECESSARY TO PREVENT DUST BUILDUP. APPLY WATER, OR OTHER DUST INHIBITING AGENTS OR TACKIFIERS, AS APPROVED BY THE NHDES.
 - 11.2. ALL STOCKPILES SHALL BE CONTAINED WITH TEMPORARY PERIMETER CONTROLS. INACTIVE SOIL STOCKPILES SHOULD BE PROTECTED WITH SOIL STABILIZATION MEASURES (TEMPORARY EROSION CONTROL SEED MIX AND MULCH, SOIL BINDER) OR COVERED WITH ANCHORED TARP.
 - 11.3. EROSION AND SEDIMENT CONTROL MEASURES WILL BE INSPECTED IN ACCORDANCE WITH SECTION 645 OF NHDOT SPECIFICATIONS. WEEKLY AND WITHIN 24 HOURS AFTER ANY STORM EVENT GREATER THAN 0.25 IN. OF RAIN PER 24-HOUR PERIOD. EROSION AND SEDIMENT CONTROL MEASURES WILL ALSO BE INSPECTED IN ACCORDANCE WITH THE GUIDANCE MEMO FROM THE NHDES CONTAINED WITHIN THE CONTRACT PROPOSAL AND THE EPA CONSTRUCTION GENERAL PERMIT.
 - 11.4. THE CONTRACTOR SHOULD UTILIZE STORM DRAIN INLET PROTECTION TO PREVENT SEDIMENT FROM ENTERING A STORM DRAINAGE SYSTEM PRIOR TO THE PERMANENT STABILIZATION OF THE CONTRIBUTING DISTURBED AREA.
 - 11.5. PERMANENT STABILIZATION MEASURES WILL BE CONSTRUCTED AND MAINTAINED IN LOCATIONS AS SHOWN ON THE CONSTRUCTION PLANS TO STABILIZE AREAS. VEGETATIVE STABILIZATION SHALL NOT BE CONSIDERED PERMANENTLY STABILIZED UNTIL VEGETATIVE GROWTH COVERS AT LEAST 85% OF THE DISTURBED AREA. THE CONTRACTOR SHALL BE RESPONSIBLE FOR EROSION AND SEDIMENT CONTROL FOR ONE YEAR AFTER PROJECT COMPLETION.
 - 11.6. CATCH BASINS: CARE SHALL BE TAKEN TO ENSURE THAT SEDIMENTS DO NOT ENTER ANY EXISTING CATCH BASINS DURING CONSTRUCTION. THE CONTRACTOR SHALL PLACE TEMPORARY STONE INLET PROTECTION OVER INLETS IN AREAS OF SOIL DISTURBANCE THAT ARE SUBJECT TO SEDIMENT CONTAMINATION.
 - 11.7. TEMPORARY AND PERMANENT DITCHES SHALL BE CONSTRUCTED, STABILIZED AND MAINTAINED IN A MANNER THAT WILL MINIMIZE SCOUR. TEMPORARY AND PERMANENT DITCHES SHALL BE DIRECTED TO DRAIN TO SEDIMENT BASINS OR STORM WATER COLLECTION AREAS.
 - 11.8. WINTER EXCAVATION AND EARTHWORK ACTIVITIES NEED TO BE LIMITED IN EXTENT AND DURATION, TO MINIMIZE POTENTIAL EROSION AND SEDIMENTATION IMPACTS. THE AREA OF EXPOSED SOIL SHALL BE LIMITED TO ONE ACRE, OR THAT WHICH CAN BE STABILIZED AT THE END OF EACH DAY UNLESS A WINTER CONSTRUCTION PLAN, DEVELOPED BY A QUALIFIED ENGINEER OR A CPESC SPECIALIST, IS REVIEWED AND APPROVED BY THE DEPARTMENT.
 - 11.9. CHANNEL PROTECTION MEASURES SHALL BE SUPPLEMENTED WITH PERIMETER CONTROL MEASURES WHEN THE DITCH LINES OCCUR AT THE BOTTOM OF LONG FILL SLOPES. THE PERIMETER CONTROLS SHALL BE INSTALLED ON THE FILL SLOPE TO MINIMIZE THE POTENTIAL FOR FILL SLOPE SEDIMENT DEPOSITS IN THE DITCH LINE.

BEST MANAGEMENT PRACTICES (BMP) BASED ON AMOUNT OF OPEN CONSTRUCTION AREA

12. STRATEGIES SPECIFIC TO OPEN AREAS LESS THAN 5 ACRES:
 - 12.1. THE CONTRACTOR SHALL COMPLY WITH RSA 485:A:17 AND ENV-WO 1500; ALTERATION OF TERRAIN FOR CONSTRUCTION AND USE ALL CONVENTIONAL BMP STRATEGIES.
 - 12.2. SLOPES STEEPER THAN 3:1 WILL RECEIVE TURF ESTABLISHMENT WITH MATTING.
 - 12.3. SLOPES 3:1 OR FLATTER WILL RECEIVE TURF ESTABLISHMENT ALONE.
 - 12.4. AREAS WHERE HAUL ROADS ARE CONSTRUCTED AND STORMWATER CANNOT BE TREATED THE DEPARTMENT WILL CONSIDER INFILTRATION.
 - 12.5. FOR HAUL ROADS ADJACENT TO SENSITIVE ENVIRONMENTAL AREAS OR STEEPER THAN 5%, THE DEPARTMENT WILL CONSIDER USING EROSION STONE, CRUSHED GRAVEL, OR CRUSHED STONE BASE TO HELP MINIMIZE EROSION ISSUES.
 - 12.6. ALL AREAS THAT CAN BE STABILIZED SHALL BE STABILIZED PRIOR TO OPENING UP NEW TERRITORY.
 - 12.7. DETENTION BASINS SHALL BE DESIGNED AND CONSTRUCTED TO ACCOMMODATE A 2 YEAR STORM EVENT.
13. STRATEGIES SPECIFIC TO OPEN AREAS BETWEEN 5 AND 10 ACRES:
 - 13.1. THE CONTRACTOR SHALL COMPLY WITH RSA 485:A:17 AND ENV-WO 1500 ALTERATION OF TERRAIN AND SHALL USE CONVENTIONAL BMP STRATEGIES AND ALL TREATMENT OPTIONS USED FOR UNDER 5 ACRES WILL BE UTILIZED.
 - 13.2. DETENTION BASINS WILL BE CONSTRUCTED TO ACCOMMODATE THE 2-YEAR 24-HOUR STORM EVENT AND CONTROL A 10-YEAR 24-HOUR STORM EVENT.
 - 13.3. SLOPES STEEPER THAN A 3:1 WILL RECEIVE TURF ESTABLISHMENT WITH MATTING OR OTHER TEMPORARY SOIL STABILIZATION MEASURES DETAILED IN TABLE 1. THE CONTRACTOR MAY ALSO CONSIDER A SOIL BINDER IN ACCORDANCE WITH THE NHDES APPROVALS OR REGULATIONS. OTHER ALTERNATIVE MEASURES, SUCH AS BONDED FIBER MATRIXES (BFMS) OR FLEXIBLE GROWTH MEDIUMS (FGMS) MAY BE UTILIZED, IF MEETING THE NHDES APPROVALS AND REGULATIONS.
 - 13.4. SLOPES 3:1 OR FLATTER WILL RECEIVE TURF ESTABLISHMENT OR OTHER TEMPORARY SOIL STABILIZATION MEASURES DETAILED IN TABLE 1. THE CONTRACTOR MAY ALSO CONSIDER A SOIL BINDER IN ACCORDANCE WITH THE NHDES APPROVALS OR REGULATIONS.
14. STRATEGIES SPECIFIC TO OPEN AREAS OVER 10 ACRES:
 - 14.1. THE CONTRACTOR SHALL COMPLY WITH RSA 485:A:17 AND ENV-WO 1500 ALTERATION OF TERRAIN AND SHALL USE CONVENTIONAL BMP STRATEGIES AND ALL TREATMENT OPTIONS USED FOR UNDER 5 ACRES AND BETWEEN 5 AND 10 ACRES WILL BE UTILIZED.
 - 14.2. THE DEPARTMENT ANTICIPATES THAT SOIL BINDERS WILL BE NEEDED ON ALL SLOPES STEEPER THAN 3:1, IN ORDER TO MINIMIZE EROSION AND REDUCE THE AMOUNT OF SEDIMENT IN THE STORMWATER TREATMENT BASINS.
 - 14.3. THE CONTRACTOR WILL BE REQUIRED TO HAVE AN APPROVED DESIGN IN ACCORDANCE WITH ENV-WO 1506.12 FOR AN ACTIVE FLOCCULANT TREATMENT SYSTEM TO TREAT AND RELEASE WATER CAPTURED IN STORM WATER BASINS. THE CONTRACTOR SHALL ALSO RETAIN THE SERVICES OF AN ENVIRONMENTAL CONSULTANT WHO HAS DEMONSTRATED EXPERIENCE IN THE DESIGN OF FLOCCULANT TREATMENT SYSTEMS. THE CONSULTANT WILL ALSO BE RESPONSIBLE FOR THE IMPLEMENTATION AND MONITORING OF THE SYSTEM.

TABLE 1
GUIDANCE ON SELECTING TEMPORARY SOIL STABILIZATION MEASURES

APPLICATION AREAS	DRY MULCH METHODS				HYDRAULICALLY APPLIED MULCHES ²				ROLLED EROSION CONTROL BLANKETS ³			
	HMT	WC	SG	CB	HM	SMM	BFM	FRM	SNSB	DNSB	DNSCB	DNCB
SLOPES ¹												
STEEPER THAN 2:1	NO	NO	YES	NO	NO	NO	NO	YES	NO	NO	NO	YES
2:1 SLOPE	YES	YES	YES	YES	NO	NO	YES	YES	NO	YES	YES	YES
3:1 SLOPE	YES	YES	YES	YES	NO	YES	YES	YES	YES	YES	YES	NO
4:1 SLOPE	YES	YES	YES	YES	YES	YES	YES	YES	YES	YES	NO	NO
WINTER STABILIZATION	4T/AC	YES	YES	YES	NO	NO	YES	YES	YES	YES	YES	YES
CHANNELS												
LOW FLOW CHANNELS	NO	NO	NO	NO	NO	NO	NO	NO	NO	NO	YES	YES
HIGH FLOW CHANNELS	NO	NO	NO	NO	NO	NO	NO	NO	NO	NO	NO	YES

ABBREV.	STABILIZATION MEASURE	ABBREV.	STABILIZATION MEASURE	ABBREV.	STABILIZATION MEASURE
HMT	HAY MULCH & TACK	HM	HYDRAULIC MULCH	SNSB	SINGLE NET STRAW BLANKET
WC	WOOD CHIPS	SMM	STABILIZED MULCH MATRIX	DNSB	DOUBLE NET STRAW BLANKET
SG	STUMP GRINDINGS	BFM	BONDED FIBER MATRIX	DNSCB	2 NET STRAW-COCONUT BLANKET
CB	COMPOST BLANKET	FRM	FIBER REINFORCED MEDIUM	DNCB	2 NET COCONUT BLANKET

- NOTES:
1. ALL SLOPE STABILIZATION OPTIONS ASSUME A SLOPE LENGTH ≤10 TIMES THE HORIZONTAL DISTANCE COMPONENT OF THE SLOPE, IN FEET.
 2. PRODUCTS CONTAINING POLYACRYLAMIDE (PAM) SHALL NOT BE APPLIED DIRECTLY TO OR WITHIN 100 FEET OF ANY SURFACE WATER WITHOUT PRIOR WRITTEN APPROVAL FROM THE NH DEPARTMENT OF ENVIRONMENTAL SERVICES.
 3. ALL EROSION CONTROL BLANKETS SHALL BE MADE WITH WILDLIFE FRIENDLY BIODEGRADABLE NETTING.

STATE OF NEW HAMPSHIRE DEPT. OF TRANSPORTATION & BUREAU OF HIGHWAY DESIGN				
EROSION CONTROL STRATEGIES AND STABILIZATION MATRIX				
REVISION DATE	DGN	STATE PROJECT NO.	SHEET NO.	TOTAL SHEETS
12-21-2015	3065STDSTRATERC	13065	5	28

SDR PROCESSED	DATE	11/01/2019	
NEW DESIGN	EMM	DATE	01/17/2020
SHEET CHECKED	KAH	DATE	
AS BUILT DETAILS		DATE	

REVISIONS AFTER PROPOSAL	STATION	DESCRIPTION

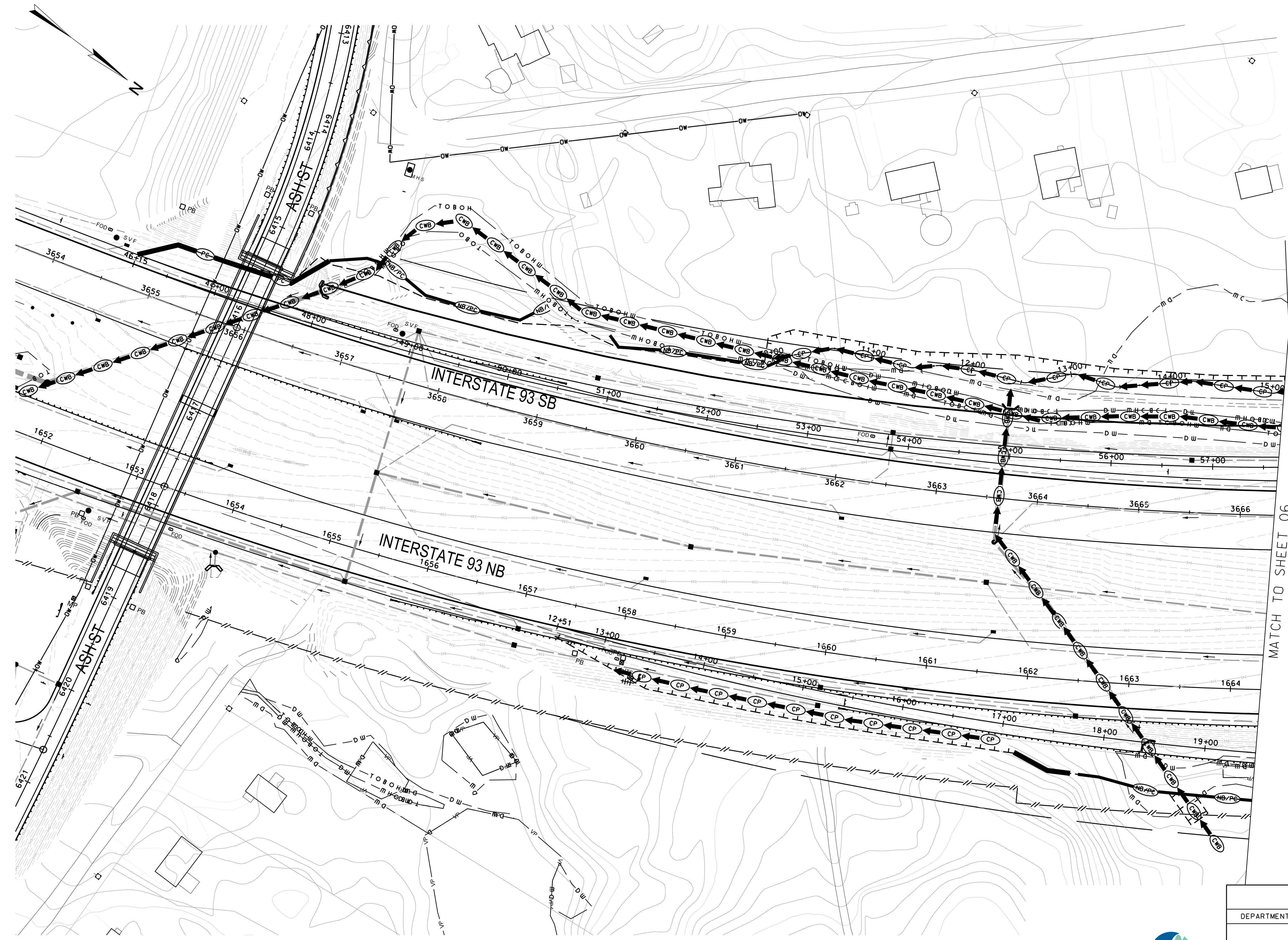

MATCH TO SHEET 06

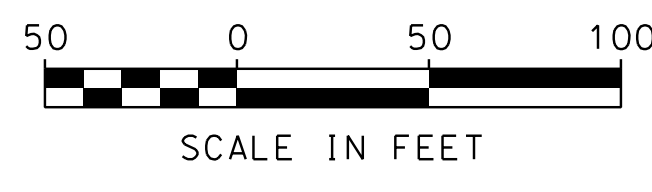

STATE OF NEW HAMPSHIRE			
DEPARTMENT OF TRANSPORTATION • BUREAU OF HIGHWAY DESIGN			
EXIT 4A			
EROSION CONTROL PLAN			
DGN	STATE PROJECT NO.	SHEET NO.	TOTAL SHEETS
13065EROPLANS	13065	6	28

SDR PROCESSED	DATE	11/01/2019
NEW DESIGN	DATE	01/17/2020
SHEET CHECKED	DATE	
AS BUILT DETAILS	DATE	

REVISIONS AFTER PROPOSAL	STATION	DESCRIPTION

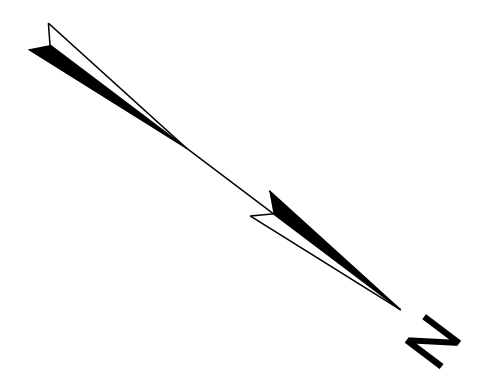

STATE OF NEW HAMPSHIRE			
DEPARTMENT OF TRANSPORTATION • BUREAU OF HIGHWAY DESIGN			
EXIT 4A			
EROSION CONTROL PLAN			
DGN	STATE PROJECT NO.	SHEET NO.	TOTAL SHEETS
13065EROPLANS	13065	7	28

SDR PROCESSED		DATE		DATE	
NEW DESIGN		11/01/2019			
SHEET CHECKED		KAH		DATE	
AS BUILT DETAILS				DATE	
REVISIONS AFTER PROPOSAL		STATION		DESCRIPTION	
NUMBER		DATE		STATION	

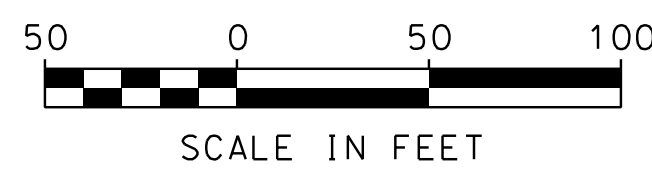
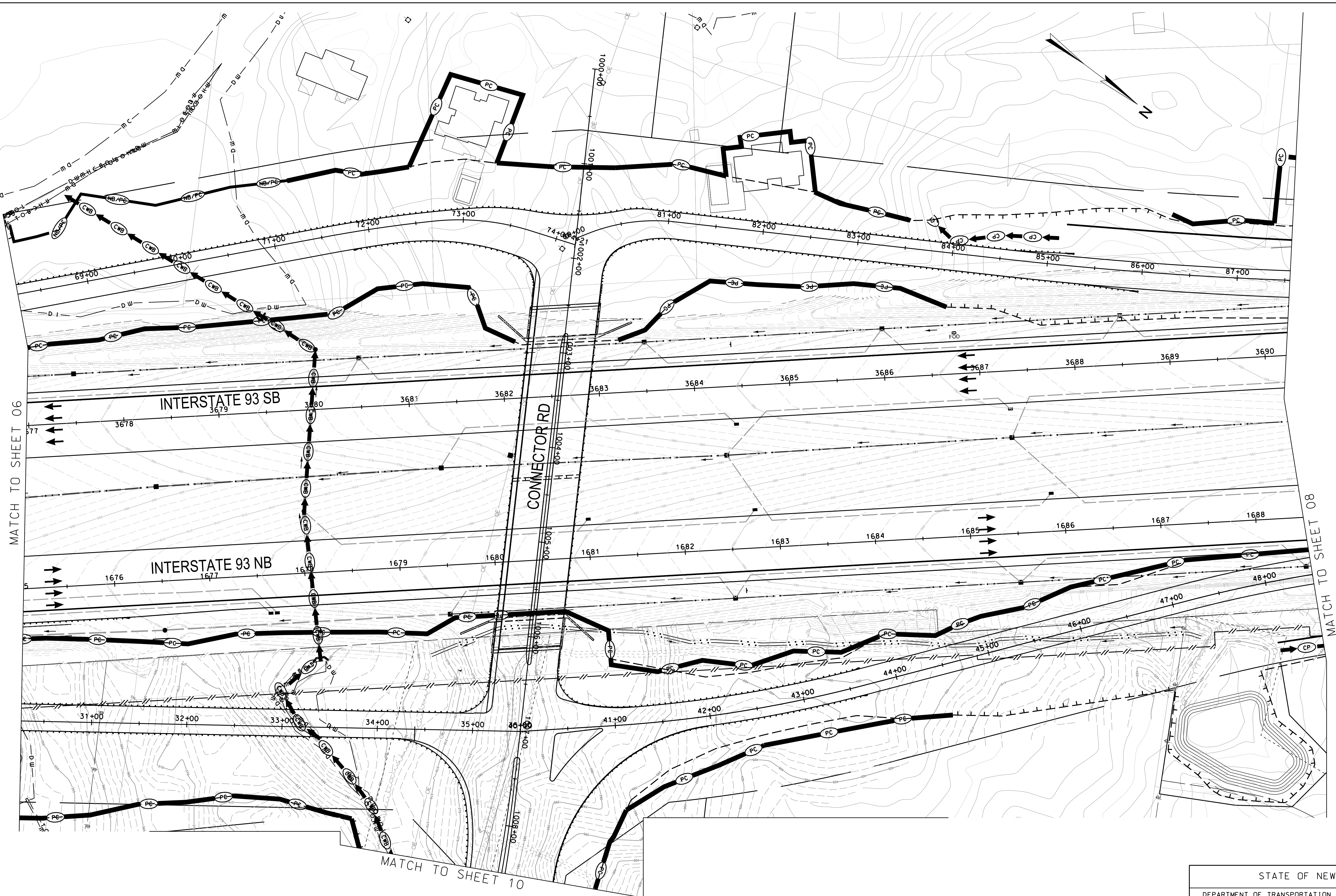

STATE OF NEW HAMPSHIRE			
DEPARTMENT OF TRANSPORTATION • BUREAU OF HIGHWAY DESIGN			
EXIT 4A EROSION CONTROL PLAN			
DGN	STATE PROJECT NO.	SHEET NO.	TOTAL SHEETS
13065EROPLANS	13065	8	28

SDR PROCESSED	DATE	11/01/2019
NEW DESIGN	EMM	
SHEET CHECKED	KAH	
AS BUILT DETAILS	DATE	

REVISIONS AFTER PROPOSAL	STATION	DESCRIPTION

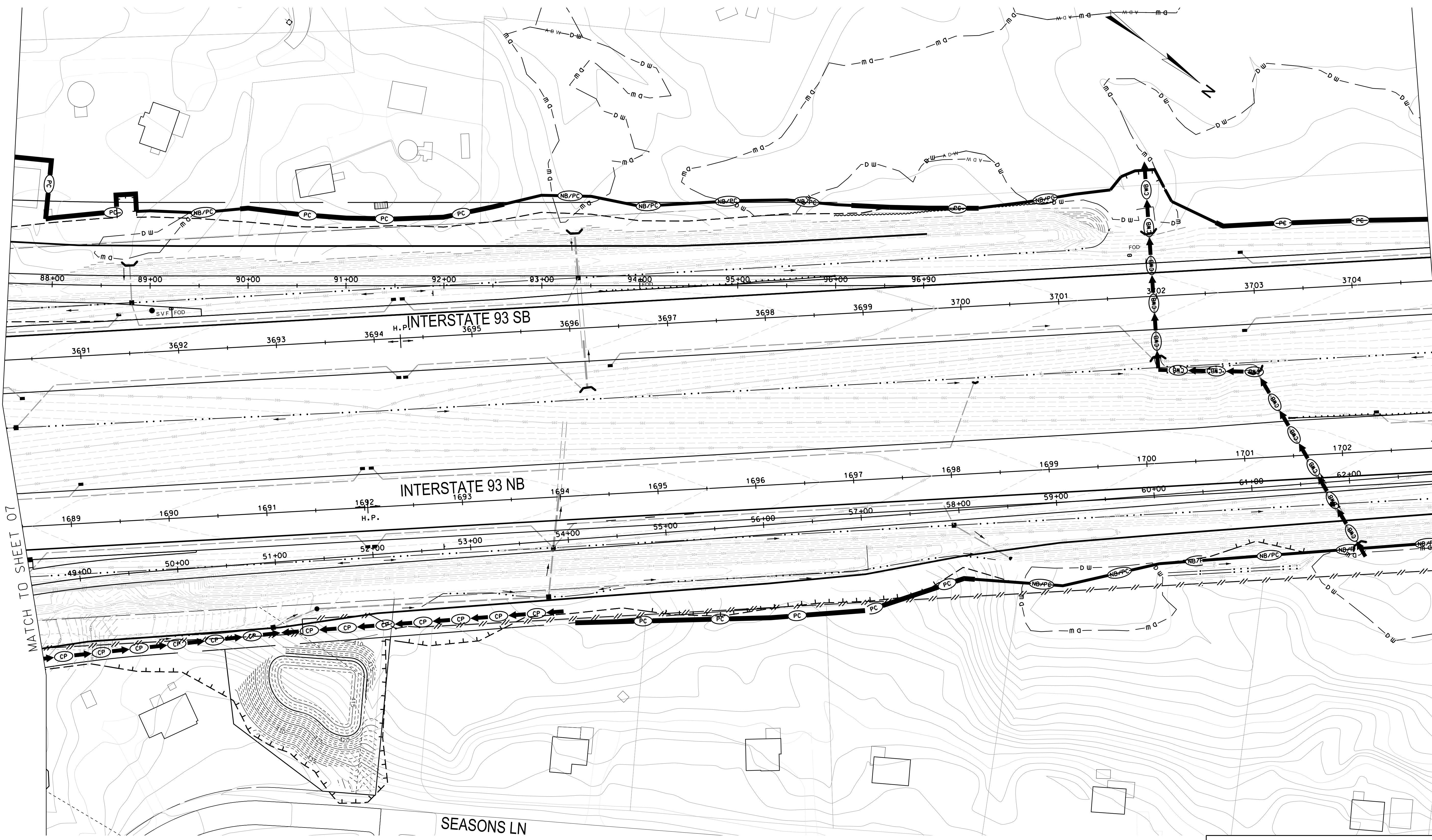

STATE OF NEW HAMPSHIRE			
DEPARTMENT OF TRANSPORTATION • BUREAU OF HIGHWAY DESIGN			
EXIT 4A			
EROSION CONTROL PLAN			
DGN	STATE PROJECT NO.	SHEET NO.	TOTAL SHEETS
13065EROPLANS	13065	9	28

SDR PROCESSED	DATE	11/01/2019
NEW DESIGN	DATE	01/17/2020
SHEET CHECKED	DATE	
AS BUILT DETAILS	DATE	

REVISIONS AFTER PROPOSAL	STATION	DESCRIPTION

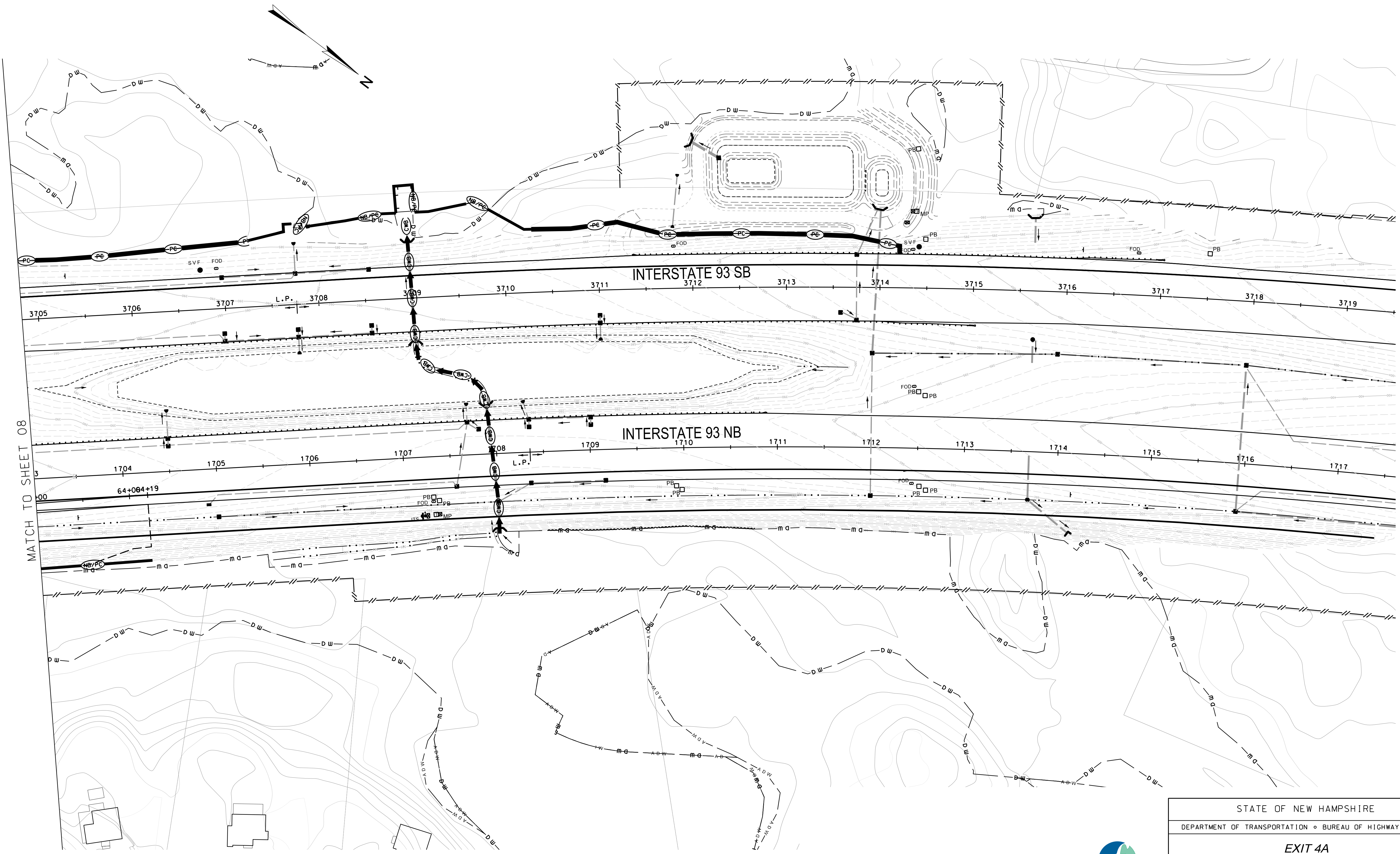

STATE OF NEW HAMPSHIRE			
DEPARTMENT OF TRANSPORTATION • BUREAU OF HIGHWAY DESIGN			
EXIT 4A			
EROSION CONTROL PLAN			
DGN	STATE PROJECT NO.	SHEET NO.	TOTAL SHEETS
13065EROPLANS	13065	10	28



SDR PROCESSED	DATE	11/01/2019	STATION	
NEW DESIGN	DATE	11/01/2019	STATION	
SHEET CHECKED	DATE	01/17/2020	DATE	
AS BUILT DETAILS	DATE		NUMBER	
			DESCRIPTION	

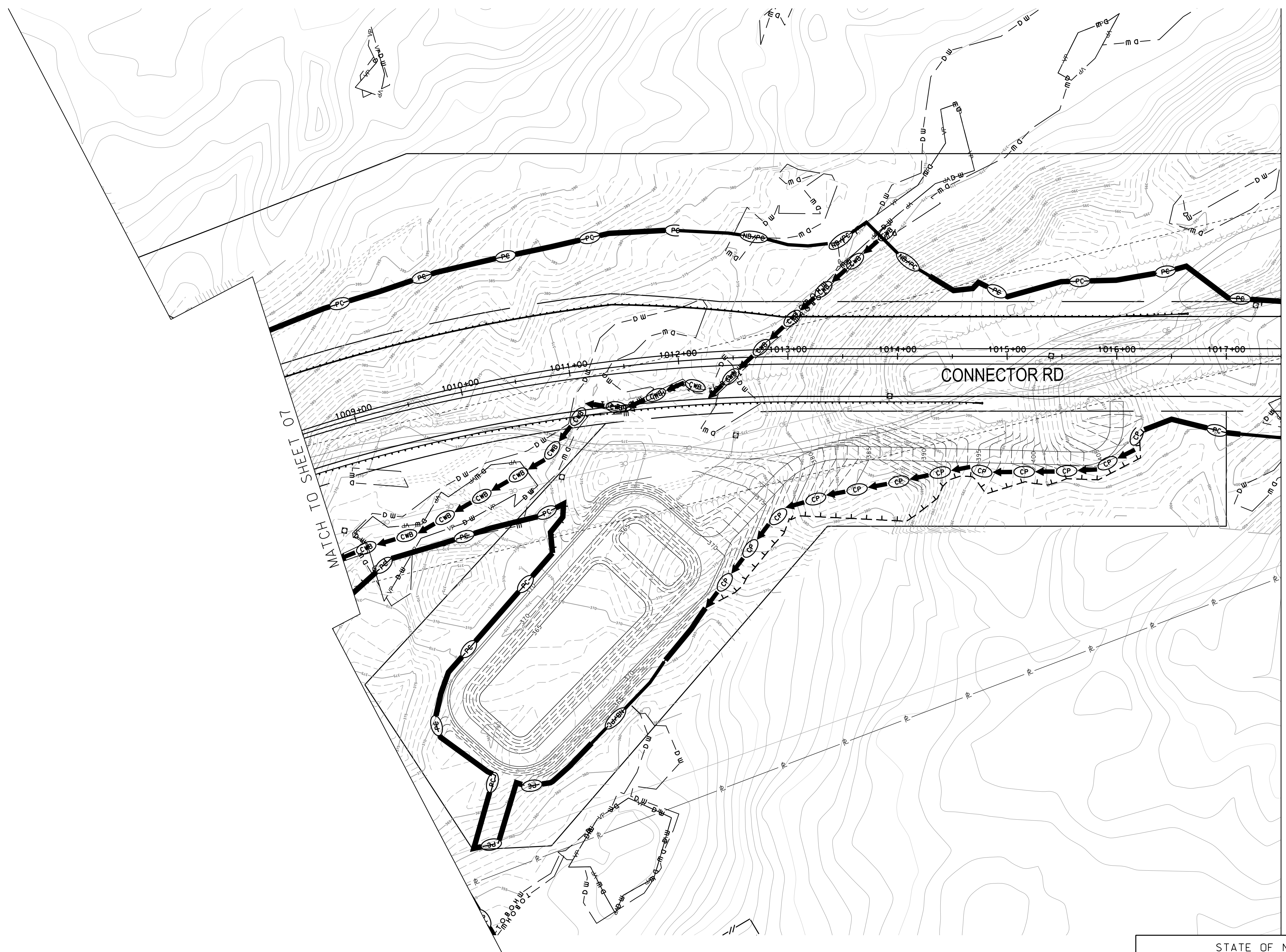
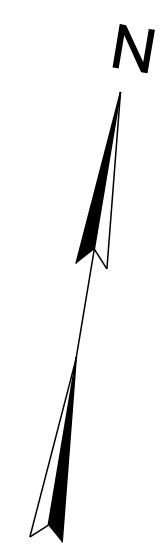

STATE OF NEW HAMPSHIRE			
DEPARTMENT OF TRANSPORTATION • BUREAU OF HIGHWAY DESIGN			
EXIT 4A			
EROSION CONTROL PLAN			
DGN	STATE PROJECT NO.	SHEET NO.	TOTAL SHEETS
13065EROPLANS	13065	11	28

SDR PROCESSED	DATE	11/01/2019
NEW DESIGN	DATE	11/01/2019
SHEET CHECKED	DATE	01/17/2020
AS BUILT DETAILS	DATE	

REVISIONS AFTER PROPOSAL	STATION	DESCRIPTION

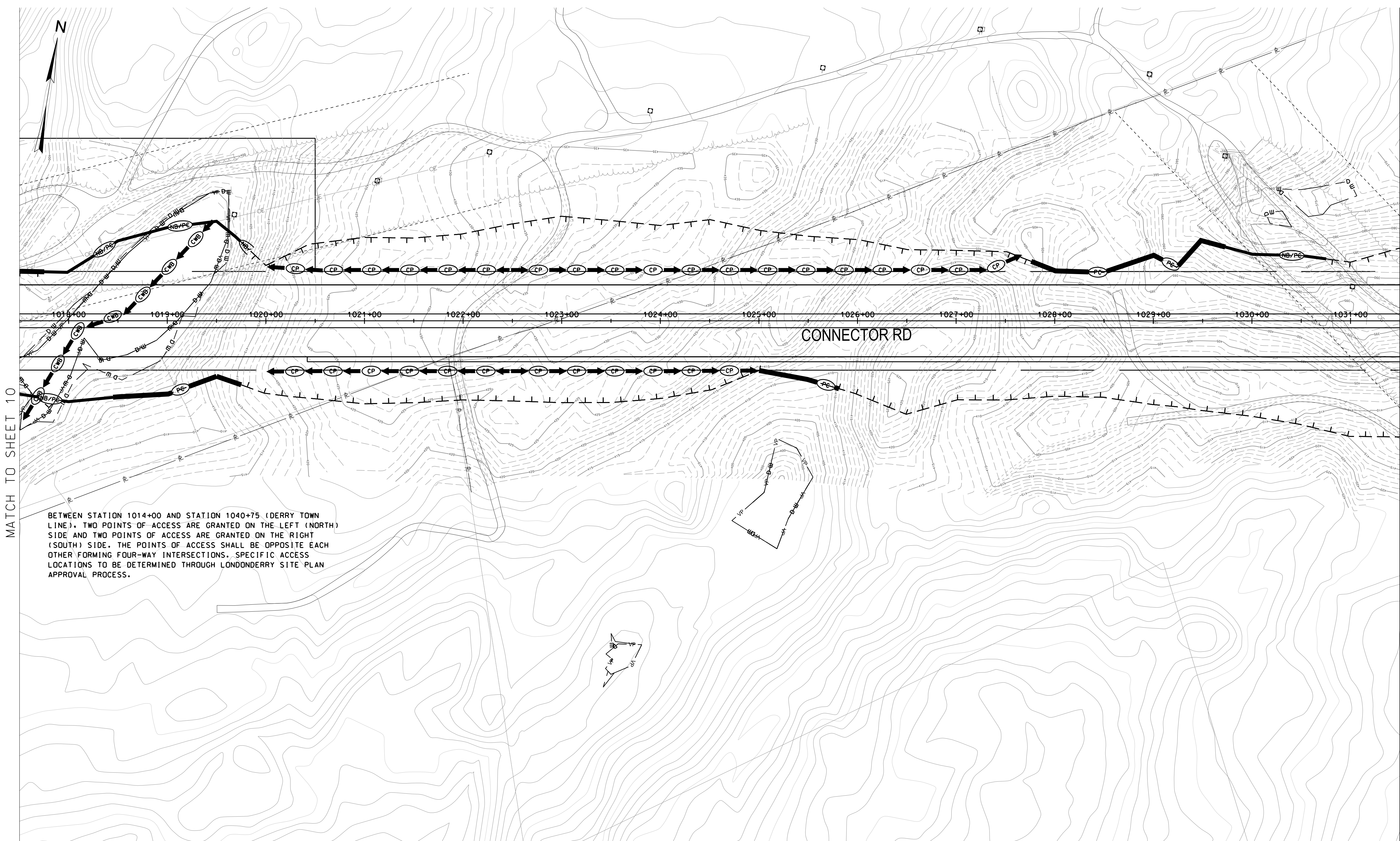

MATCH TO SHEET 10

MATCH TO SHEET 12

BETWEEN STATION 1014+00 AND STATION 1040+75 (DERRY TOWN LINE). TWO POINTS OF ACCESS ARE GRANTED ON THE LEFT (NORTH) SIDE AND TWO POINTS OF ACCESS ARE GRANTED ON THE RIGHT (SOUTH) SIDE. THE POINTS OF ACCESS SHALL BE OPPOSITE EACH OTHER FORMING FOUR-WAY INTERSECTIONS. SPECIFIC ACCESS LOCATIONS TO BE DETERMINED THROUGH LONDONDERRY SITE PLAN APPROVAL PROCESS.



STATE OF NEW HAMPSHIRE			
DEPARTMENT OF TRANSPORTATION • BUREAU OF HIGHWAY DESIGN			
EXIT 4A			
EROSION CONTROL PLAN			
DGN	STATE PROJECT NO.	SHEET NO.	TOTAL SHEETS
13065EROPLANS	13065	12	28

SDR PROCESSED	DATE	11/01/2019
NEW DESIGN	DATE	01/17/2020
SHEET CHECKED	DATE	
AS BUILT DETAILS	DATE	

REVISIONS AFTER PROPOSAL	STATION	DESCRIPTION

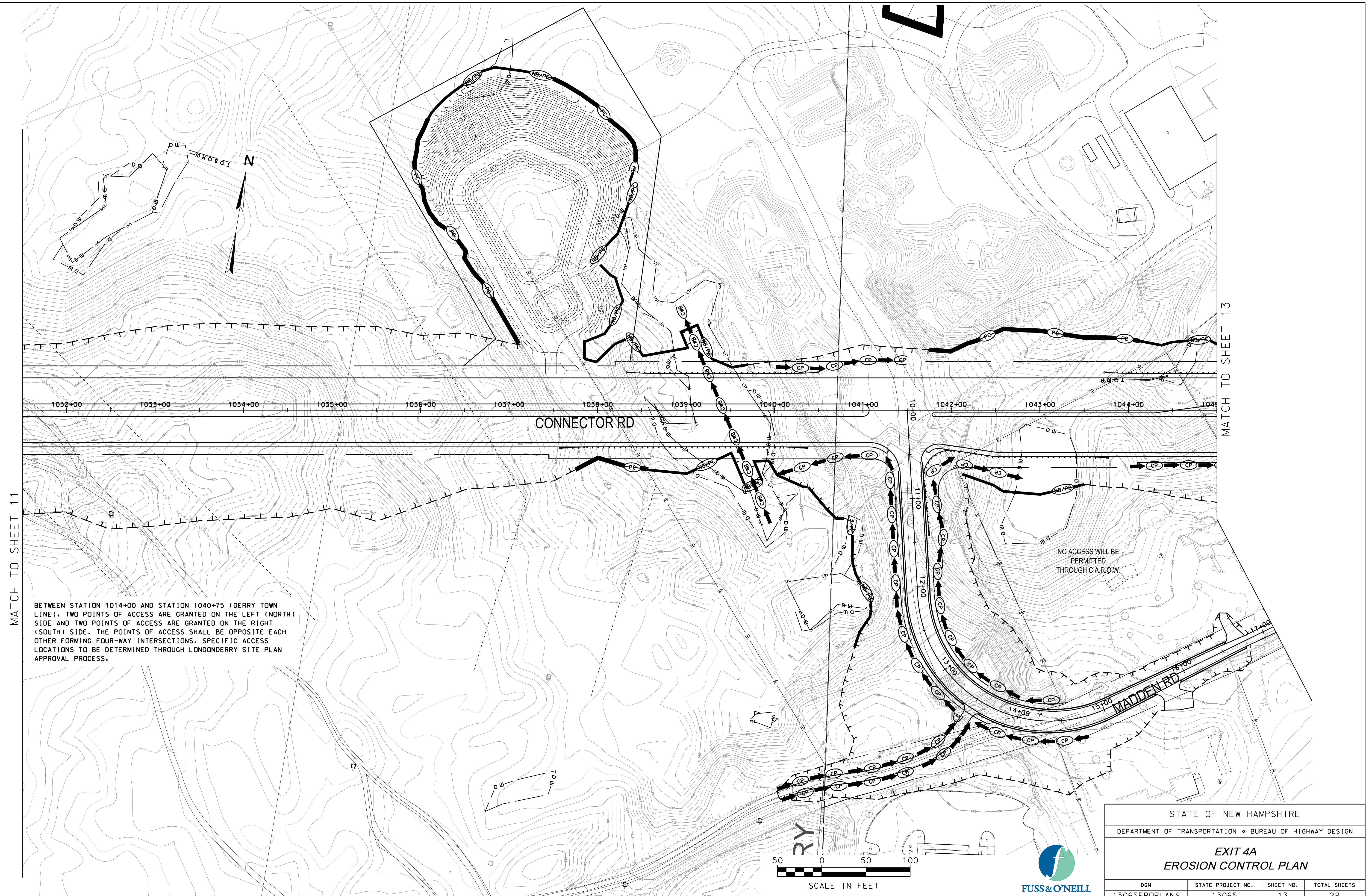

MATCH TO SHEET 11

MATCH TO SHEET 13

BETWEEN STATION 1014+00 AND STATION 1040+75 (DERRY TOWN LINE). TWO POINTS OF ACCESS ARE GRANTED ON THE LEFT (NORTH) SIDE AND TWO POINTS OF ACCESS ARE GRANTED ON THE RIGHT (SOUTH) SIDE. THE POINTS OF ACCESS SHALL BE OPPOSITE EACH OTHER FORMING FOUR-WAY INTERSECTIONS. SPECIFIC ACCESS LOCATIONS TO BE DETERMINED THROUGH LONDONDERRY SITE PLAN APPROVAL PROCESS.

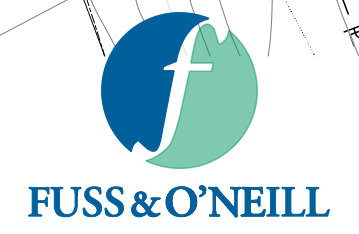
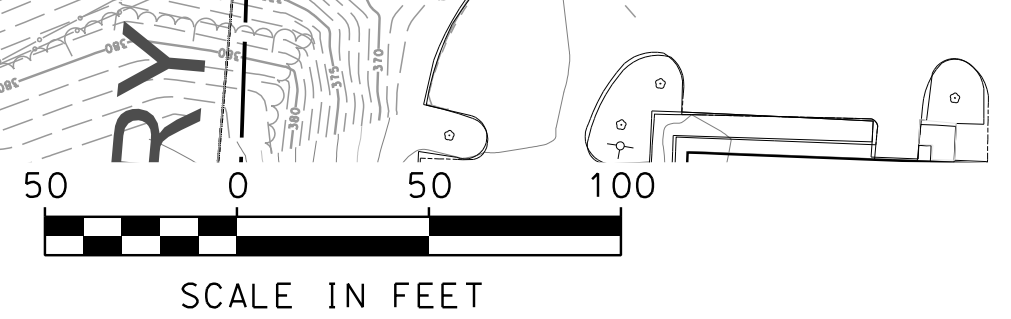

STATE OF NEW HAMPSHIRE			
DEPARTMENT OF TRANSPORTATION • BUREAU OF HIGHWAY DESIGN			
EXIT 4A			
EROSION CONTROL PLAN			
DGN	STATE PROJECT NO.	SHEET NO.	TOTAL SHEETS
13065EROPLANS	13065	13	28

SDR PROCESSED		DATE	11/01/2019
NEW DESIGN		DATE	01/17/2020
SHEET CHECKED		DATE	
AS BUILT DETAILS		DATE	

NUMBER	DATE	STATION	DESCRIPTION

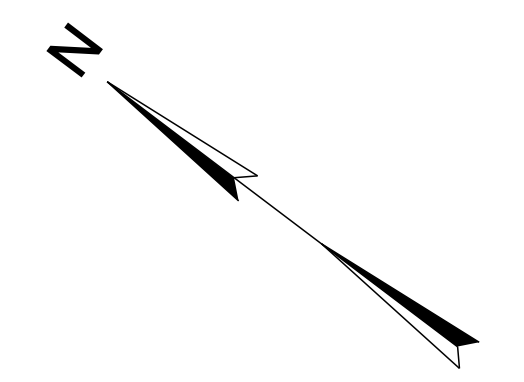

STATE OF NEW HAMPSHIRE			
DEPARTMENT OF TRANSPORTATION • BUREAU OF HIGHWAY DESIGN			
EXIT 4A EROSION CONTROL PLAN			
DGN	STATE PROJECT NO.	SHEET NO.	TOTAL SHEETS
13065EROPLANS	13065	14	28

SDR PROCESSED		DATE	11/01/2019
NEW DESIGN		DATE	11/01/2019
SHEET CHECKED		DATE	01/17/2020
AS BUILT DETAILS		DATE	

REVISIONS AFTER PROPOSAL	DESCRIPTION
NUMBER	DATE
STATION	STATION

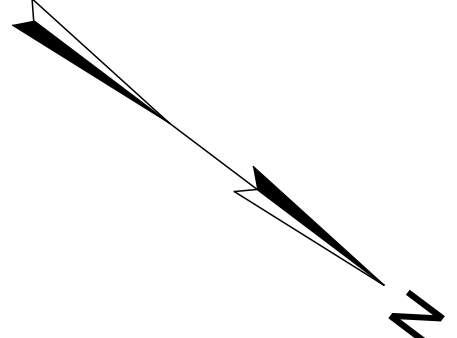

STATE OF NEW HAMPSHIRE			
DEPARTMENT OF TRANSPORTATION • BUREAU OF HIGHWAY DESIGN			
EXIT 4A			
EROSION CONTROL PLAN			
DGN	STATE PROJECT NO.	SHEET NO.	TOTAL SHEETS
13065EROPLANS	13065	15	28



MATCH TO SHEET 17

MATCH TO SHEET 13

MATCH TO SHEET 15

SDR PROCESSED	DATE	11/01/2019	STATION	
NEW DESIGN	DATE	01/17/2020	STATION	
SHEET CHECKED	DATE		DATE	
AS BUILT DETAILS	DATE		DATE	

REVISIONS AFTER PROPOSAL	DESCRIPTION

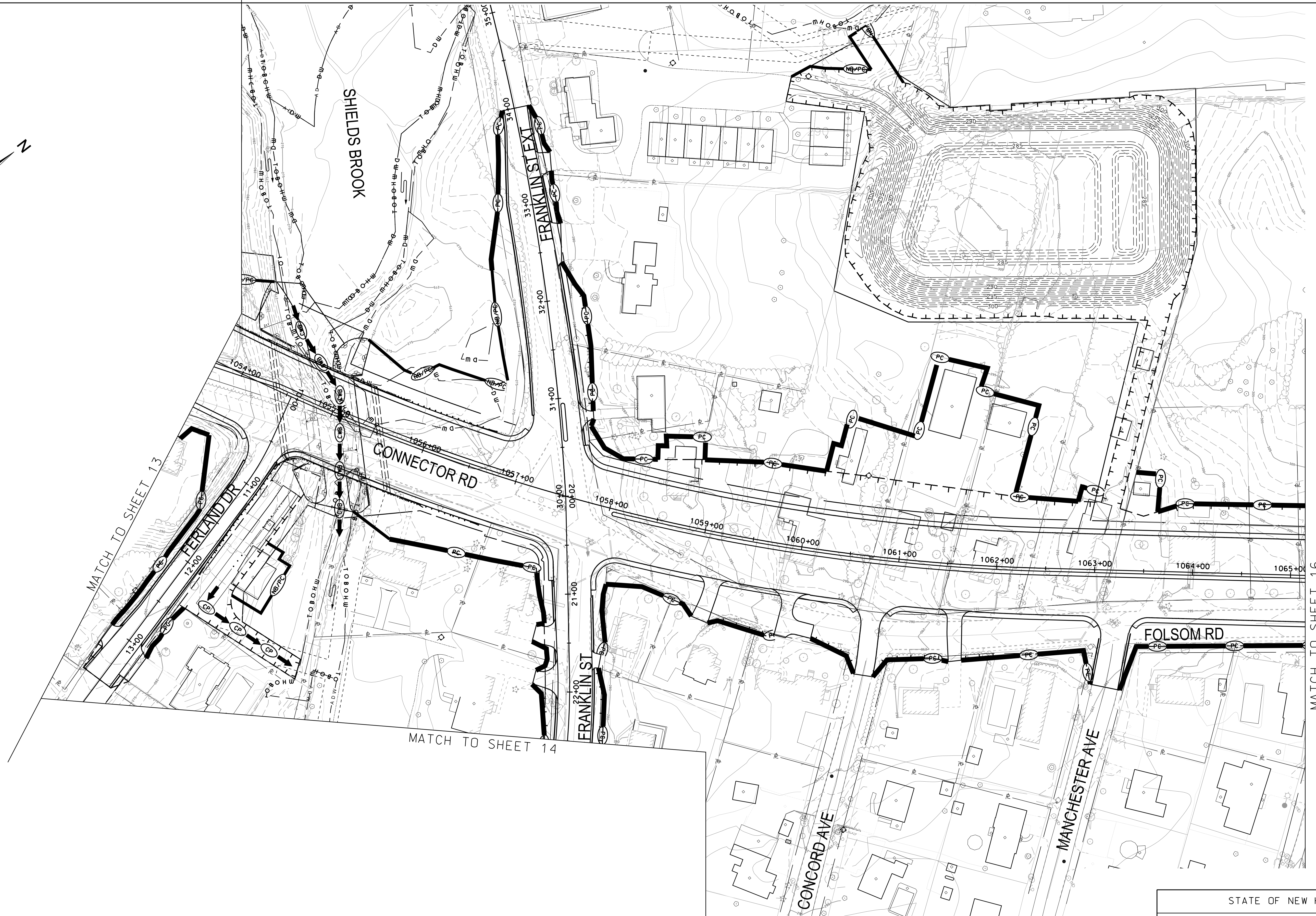
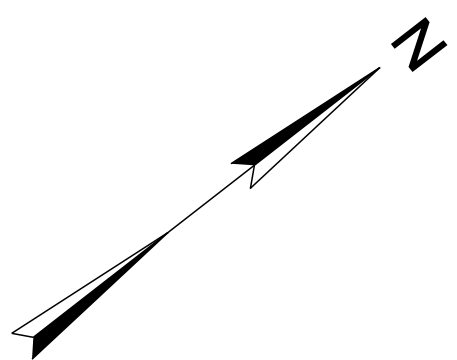

STATE OF NEW HAMPSHIRE			
DEPARTMENT OF TRANSPORTATION • BUREAU OF HIGHWAY DESIGN			
EXIT 4A			
EROSION CONTROL PLAN			
DGN	STATE PROJECT NO.	SHEET NO.	TOTAL SHEETS
13065EROPLANS	13065	16	28

SDR PROCESSED	DATE	11/01/2019	REVISIONS AFTER PROPOSAL	STATION	DESCRIPTION
NEW DESIGN	DATE	11/01/2019			
SHEET CHECKED	DATE	01/17/2020			
AS BUILT DETAILS	DATE				

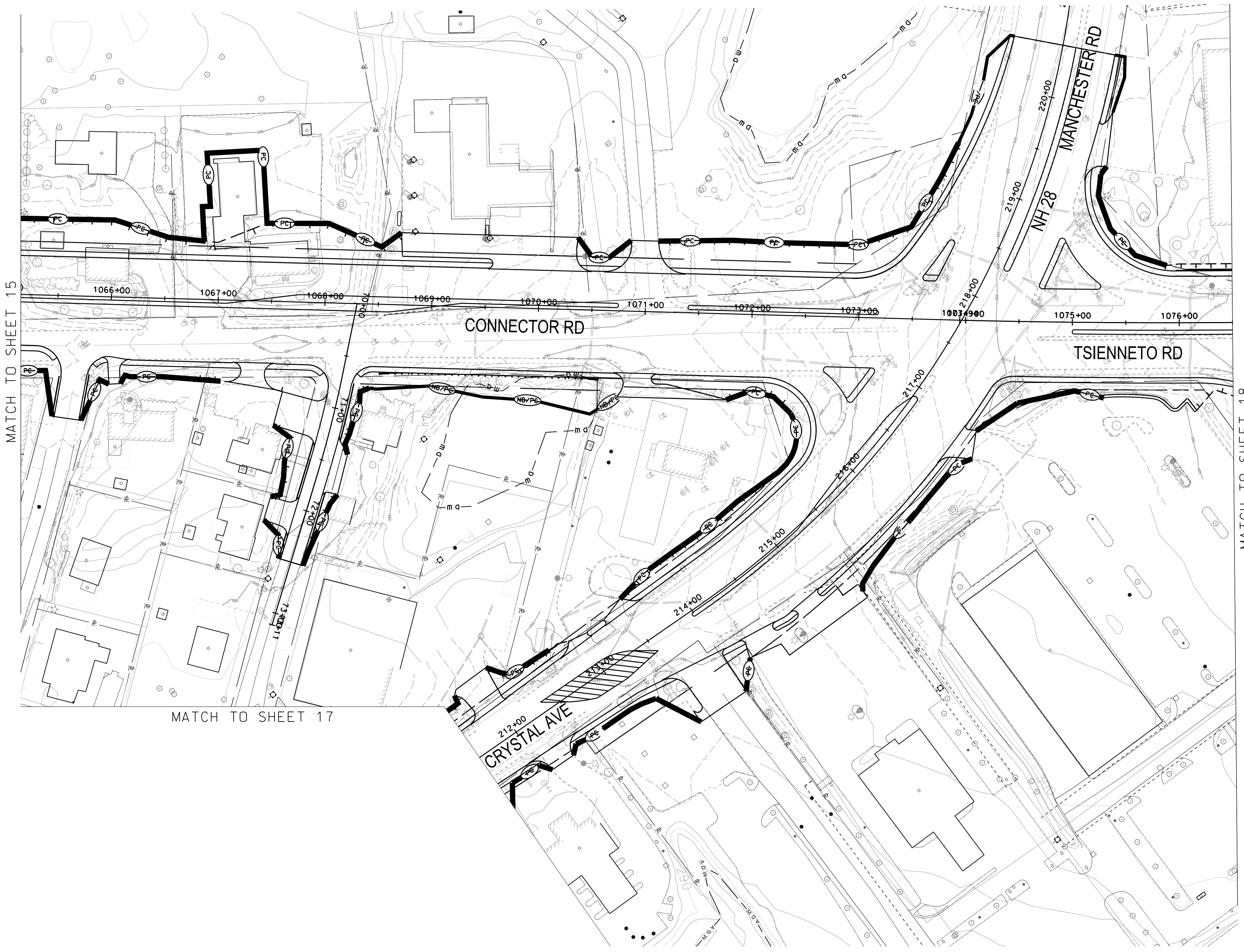
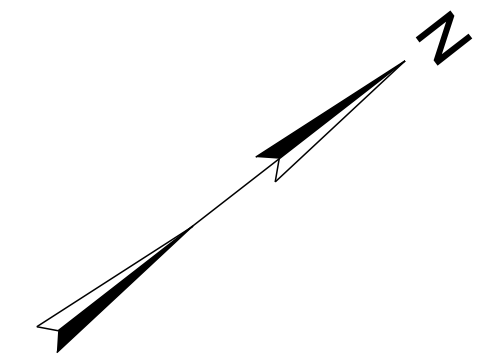

STATE OF NEW HAMPSHIRE			
DEPARTMENT OF TRANSPORTATION • BUREAU OF HIGHWAY DESIGN			
EXIT 4A			
EROSION CONTROL PLAN			
DGN	STATE PROJECT NO.	SHEET NO.	TOTAL SHEETS
13065EROPLANS	13065	17	28

SDR PROCESSED		DATE	11/01/2019	STATION	
NEW DESIGN		DATE	01/17/2020	STATION	
SHEET CHECKED		DATE		NUMBER	
AS BUILT DETAILS		DATE		DESCRIPTION	

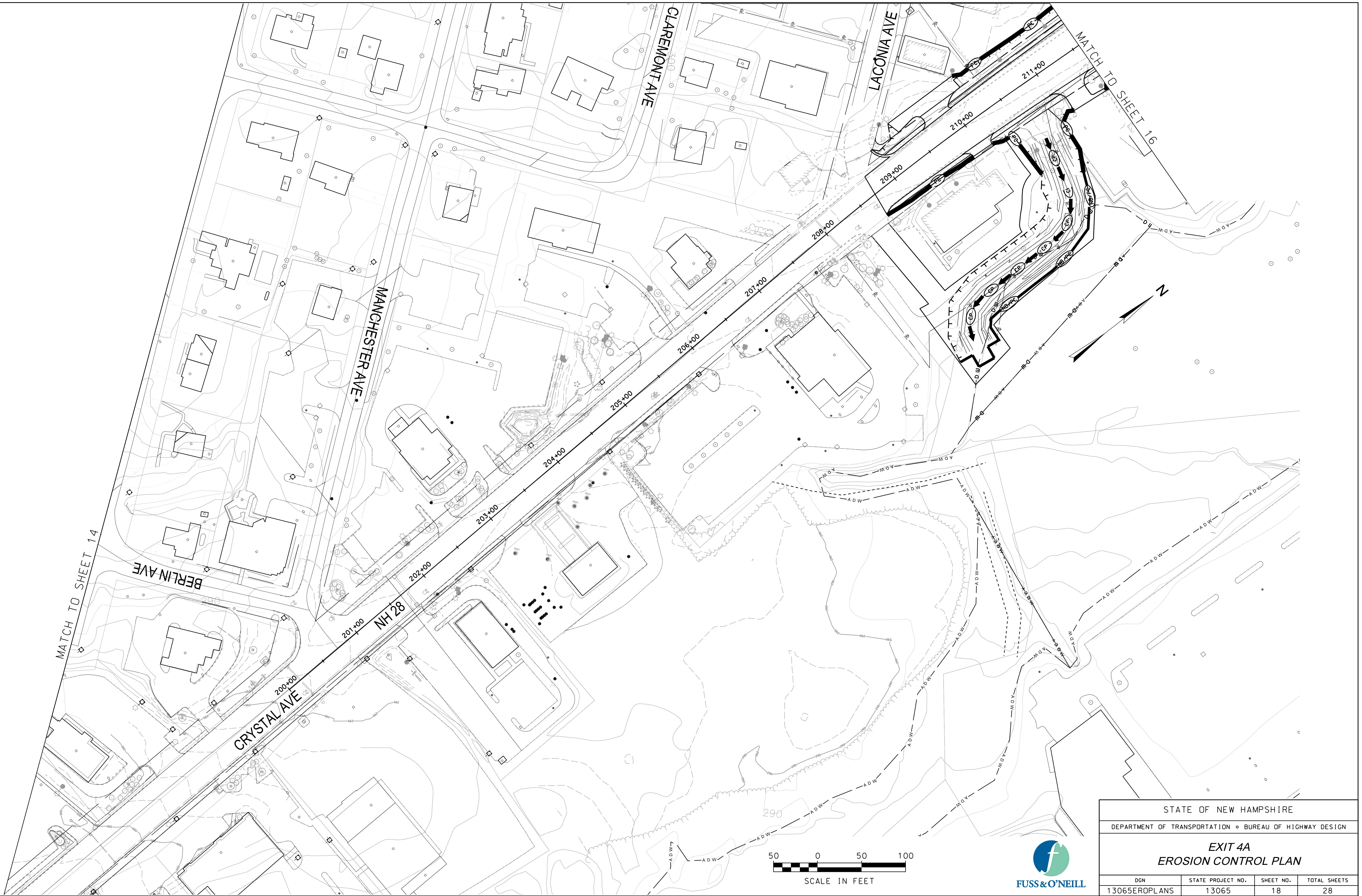

STATE OF NEW HAMPSHIRE			
DEPARTMENT OF TRANSPORTATION • BUREAU OF HIGHWAY DESIGN			
EXIT 4A			
EROSION CONTROL PLAN			
DGN	STATE PROJECT NO.	SHEET NO.	TOTAL SHEETS
13065EROPLANS	13065	18	28



SDR PROCESSED		DATE		11/01/2019	
NEW DESIGN		DATE		01/17/2020	
SHEET CHECKED		DATE		01/17/2020	
AS BUILT DETAILS		DATE			
REVISIONS AFTER PROPOSAL		NUMBER		DATE	
		STATION		DESCRIPTION	

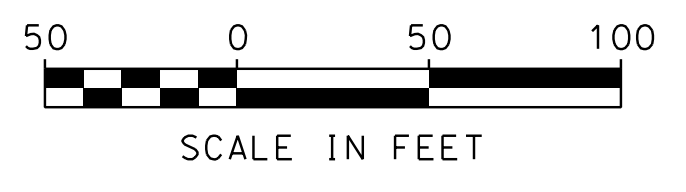
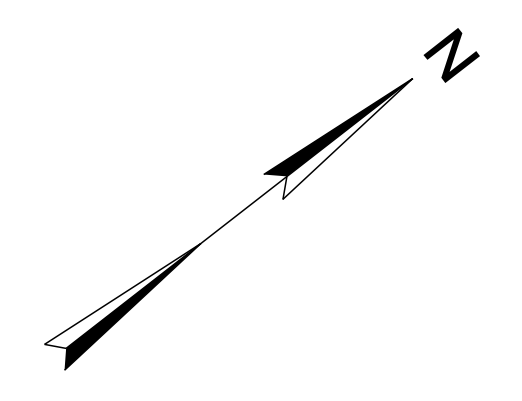
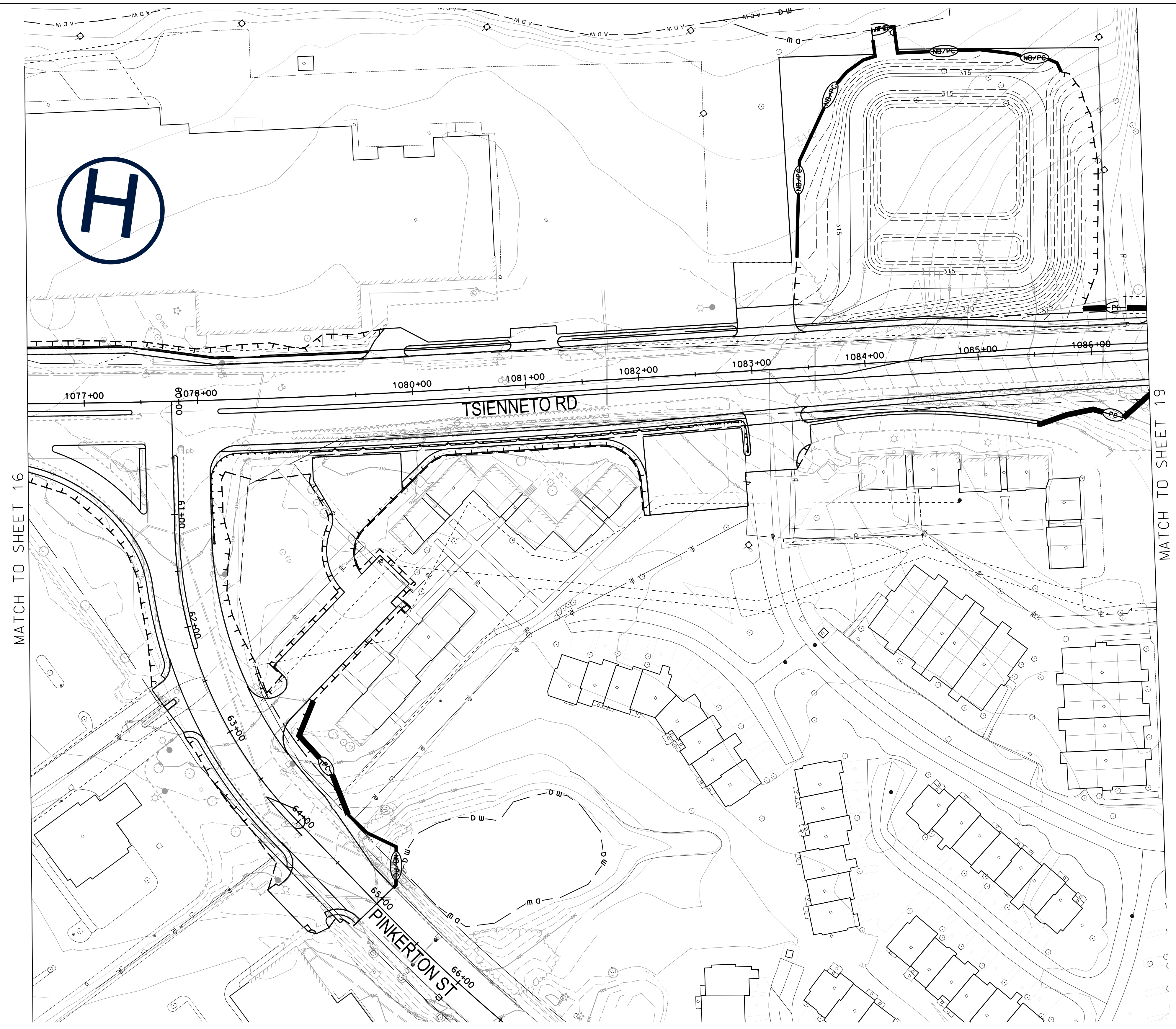

STATE OF NEW HAMPSHIRE			
DEPARTMENT OF TRANSPORTATION • BUREAU OF HIGHWAY DESIGN			
EXIT 4A			
EROSION CONTROL PLAN			
DGN	STATE PROJECT NO.	SHEET NO.	TOTAL SHEETS
13065EROPLANS	13065	19	28

SDR PROCESSED		DATE	11/01/2019
NEW DESIGN		DATE	01/17/2020
SHEET CHECKED		DATE	
AS BUILT DETAILS		DATE	

REVISIONS AFTER PROPOSAL	DESCRIPTION	STATION

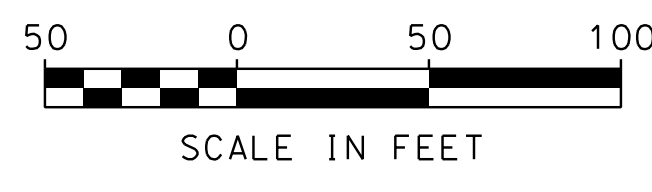

STATE OF NEW HAMPSHIRE			
DEPARTMENT OF TRANSPORTATION • BUREAU OF HIGHWAY DESIGN			
EXIT 4A			
EROSION CONTROL PLAN			
DGN	STATE PROJECT NO.	SHEET NO.	TOTAL SHEETS
13065EROPLANS	13065	20	28

SDR PROCESSED	DATE	11/01/2019	REVISIONS AFTER PROPOSAL	STATION	DESCRIPTION
NEW DESIGN	DATE	01/17/2020			
SHEET CHECKED	DATE				
AS BUILT DETAILS	DATE				

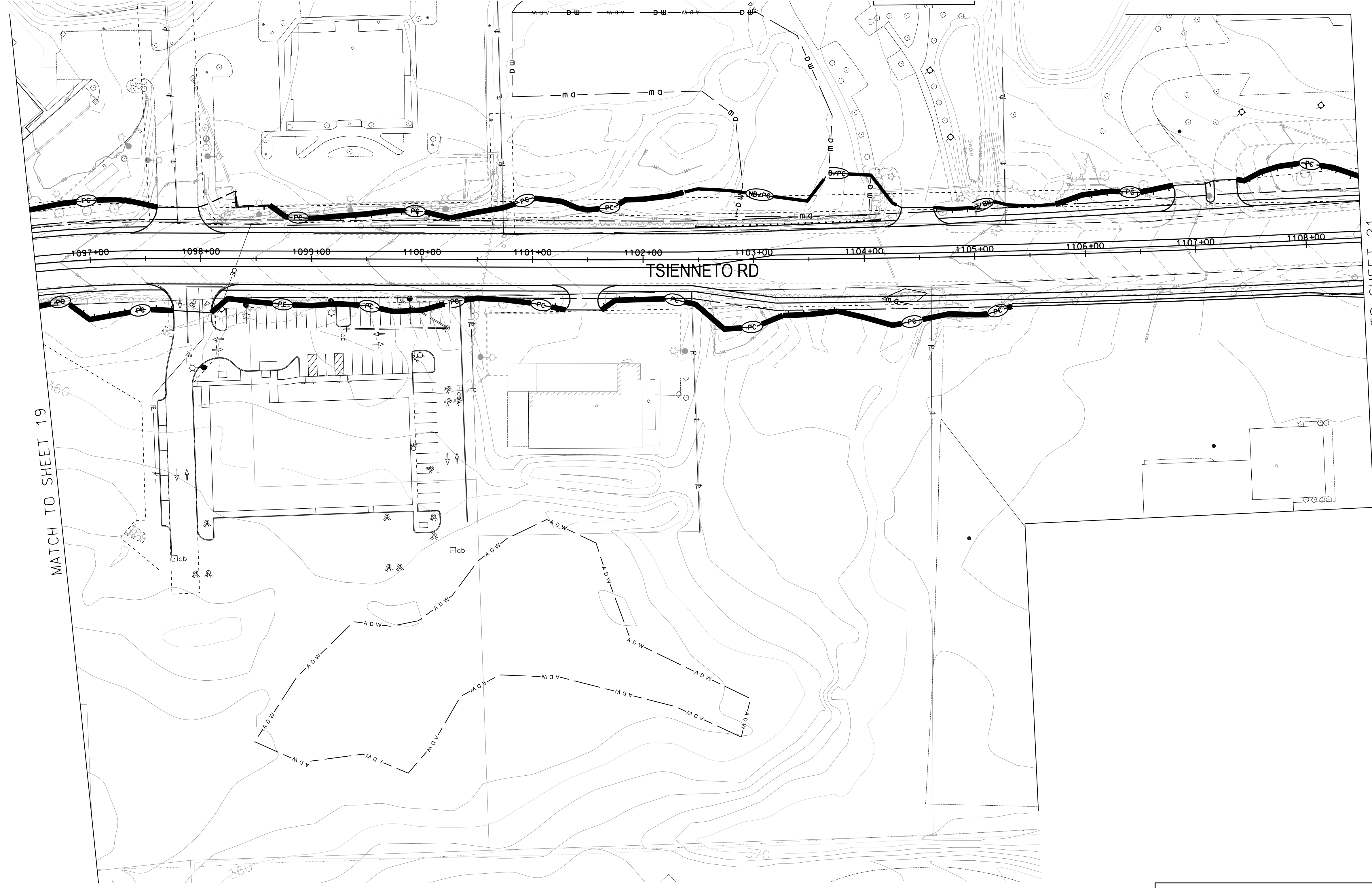
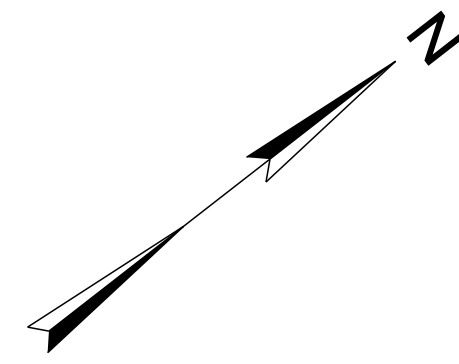

MATCH TO SHEET 19

MATCH TO SHEET 21



STATE OF NEW HAMPSHIRE			
DEPARTMENT OF TRANSPORTATION • BUREAU OF HIGHWAY DESIGN			
EXIT 4A			
EROSION CONTROL PLAN			
DGN	STATE PROJECT NO.	SHEET NO.	TOTAL SHEETS
13065EROPLANS	13065	21	28

SDR PROCESSED		DATE	11/01/2019
NEW DESIGN		EMM	DATE
SHEET CHECKED		KAH	DATE
AS BUILT DETAILS		DATE	

REVISIONS AFTER PROPOSAL		STATION	DESCRIPTION
NUMBER	DATE	STATION	DESCRIPTION



STATE OF NEW HAMPSHIRE			
DEPARTMENT OF TRANSPORTATION • BUREAU OF HIGHWAY DESIGN			
EXIT 4A			
EROSION CONTROL PLAN			
DGN	STATE PROJECT NO.	SHEET NO.	TOTAL SHEETS
13065EROPLANS	13065	22	28

MATCH TO SHEET 22

MATCH TO SHEET 23

MATCH TO SHEET 20

SDR PROCESSED	DATE	11/01/2019
NEW DESIGN	EMM	
SHEET CHECKED	KAH	
AS BUILT DETAILS	DATE	

REVISIONS AFTER PROPOSAL	STATION	DESCRIPTION

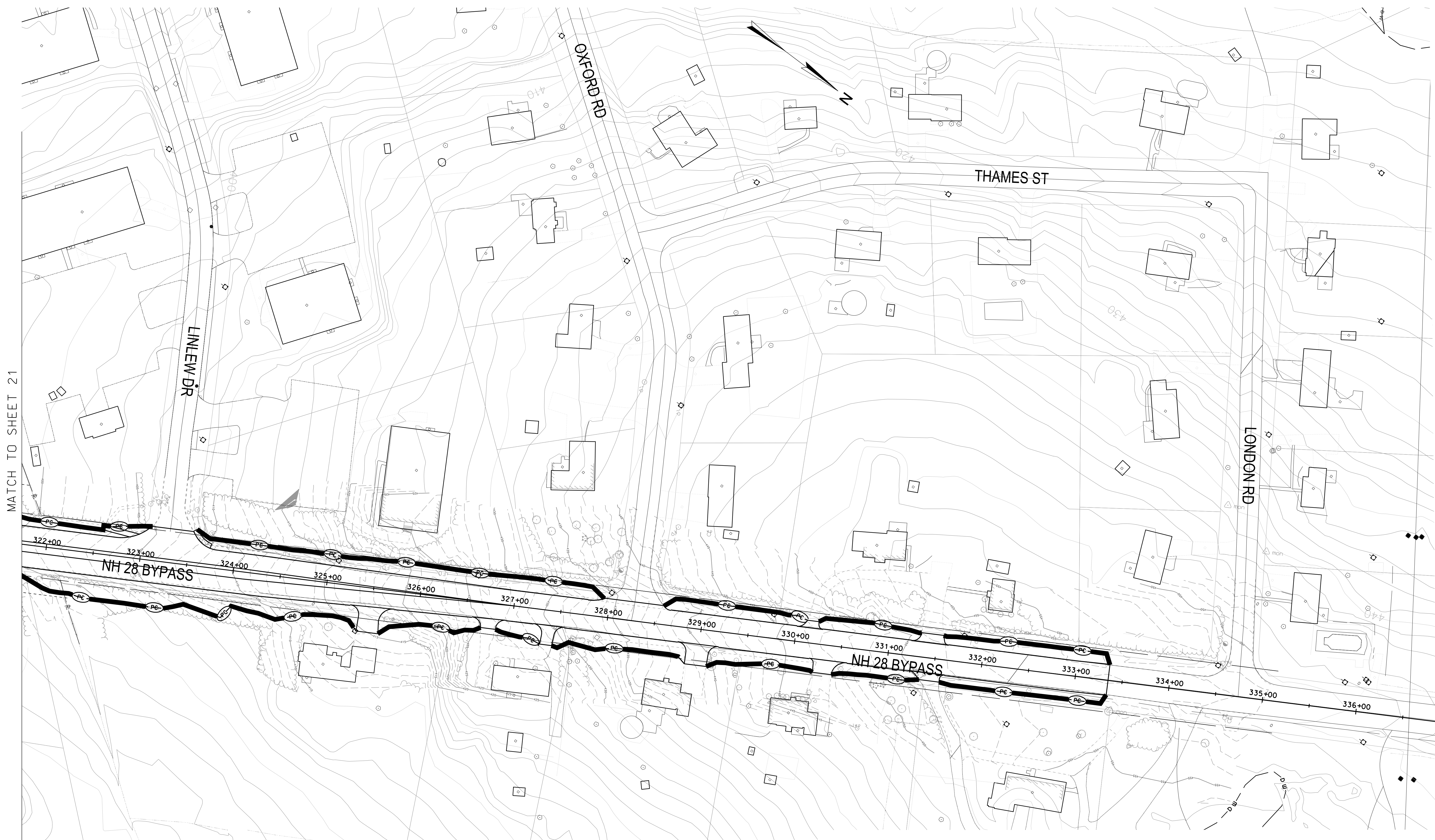

MATCH TO SHEET 21

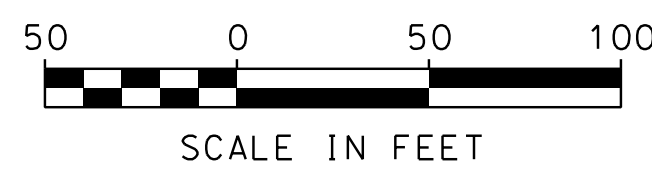

STATE OF NEW HAMPSHIRE			
DEPARTMENT OF TRANSPORTATION • BUREAU OF HIGHWAY DESIGN			
EXIT 4A			
EROSION CONTROL PLAN			
DGN	STATE PROJECT NO.	SHEET NO.	TOTAL SHEETS
13065EROPLANS	13065	23	28

SDR PROCESSED		DATE	11/01/2019
NEW DESIGN		EMM	
SHEET CHECKED		KAH	
AS BUILT DETAILS		DATE	

REVISIONS AFTER PROPOSAL		STATION	DESCRIPTION
NUMBER	DATE		

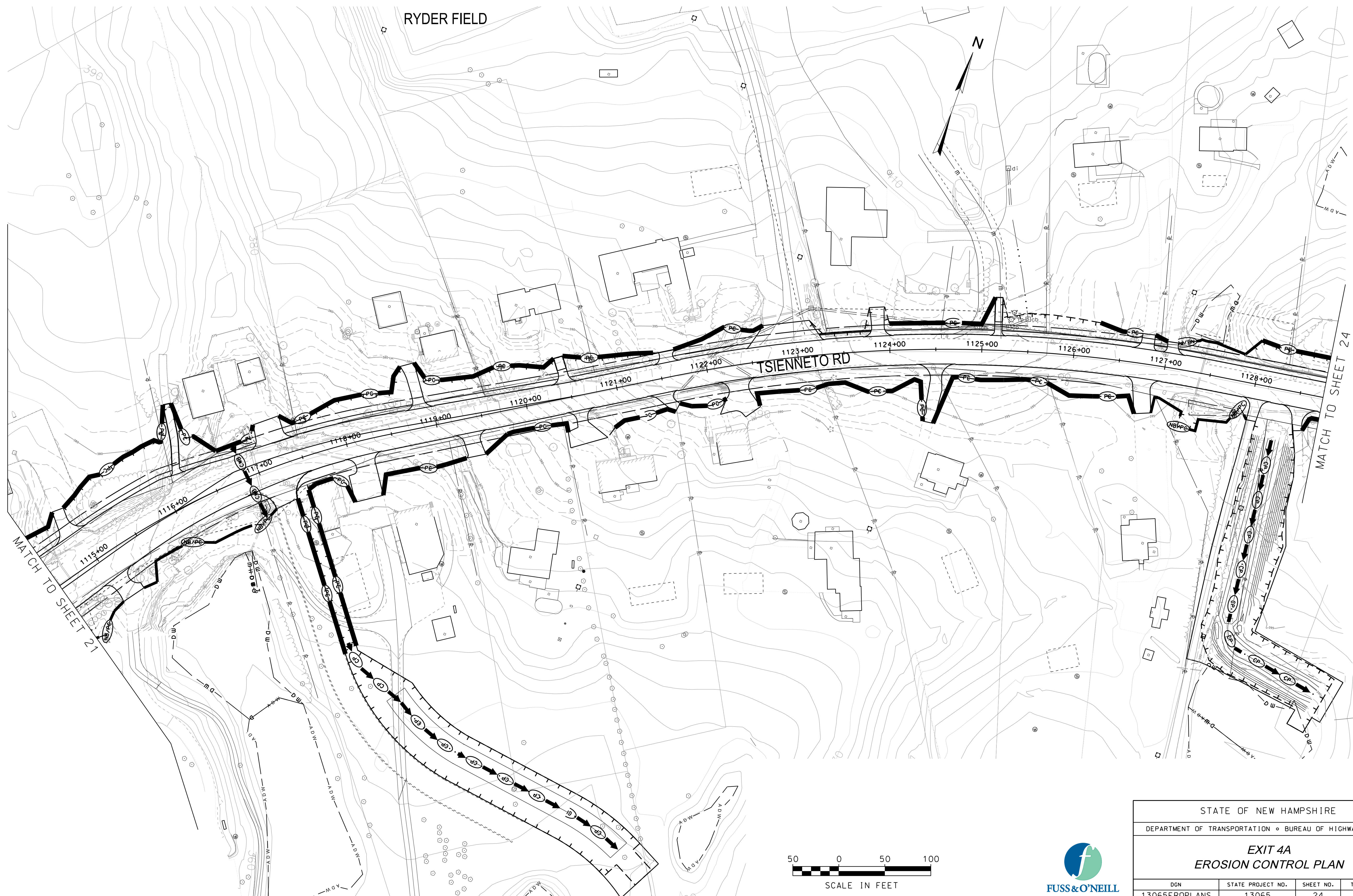

STATE OF NEW HAMPSHIRE			
DEPARTMENT OF TRANSPORTATION • BUREAU OF HIGHWAY DESIGN			
EXIT 4A			
EROSION CONTROL PLAN			
DGN	STATE PROJECT NO.	SHEET NO.	TOTAL SHEETS
13065EROPLANS	13065	24	28

SDR PROCESSED	DATE	11/01/2019	STATION	
NEW DESIGN	DATE	01/17/2020	STATION	
SHEET CHECKED	DATE		DATE	
AS BUILT DETAILS	DATE		DATE	



STATE OF NEW HAMPSHIRE			
DEPARTMENT OF TRANSPORTATION • BUREAU OF HIGHWAY DESIGN			
EXIT 4A			
EROSION CONTROL PLAN			
DGN	STATE PROJECT NO.	SHEET NO.	TOTAL SHEETS
13065EROPLANS	13065	25	28

SDR PROCESSED		REVISIONS AFTER PROPOSAL	
DATE	DATE	STATION	DESCRIPTION
11/01/2019	11/01/2019		
EMM	EMM		
01/17/2020	01/17/2020		
KAH	KAH		
AS BUILT DETAILS			

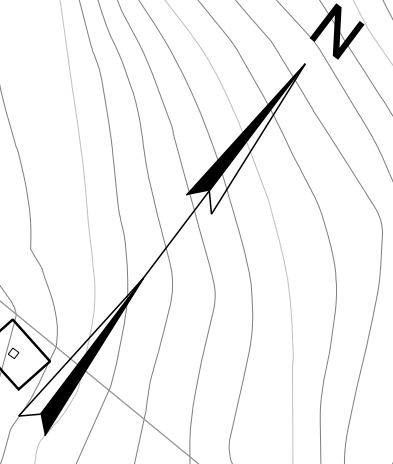
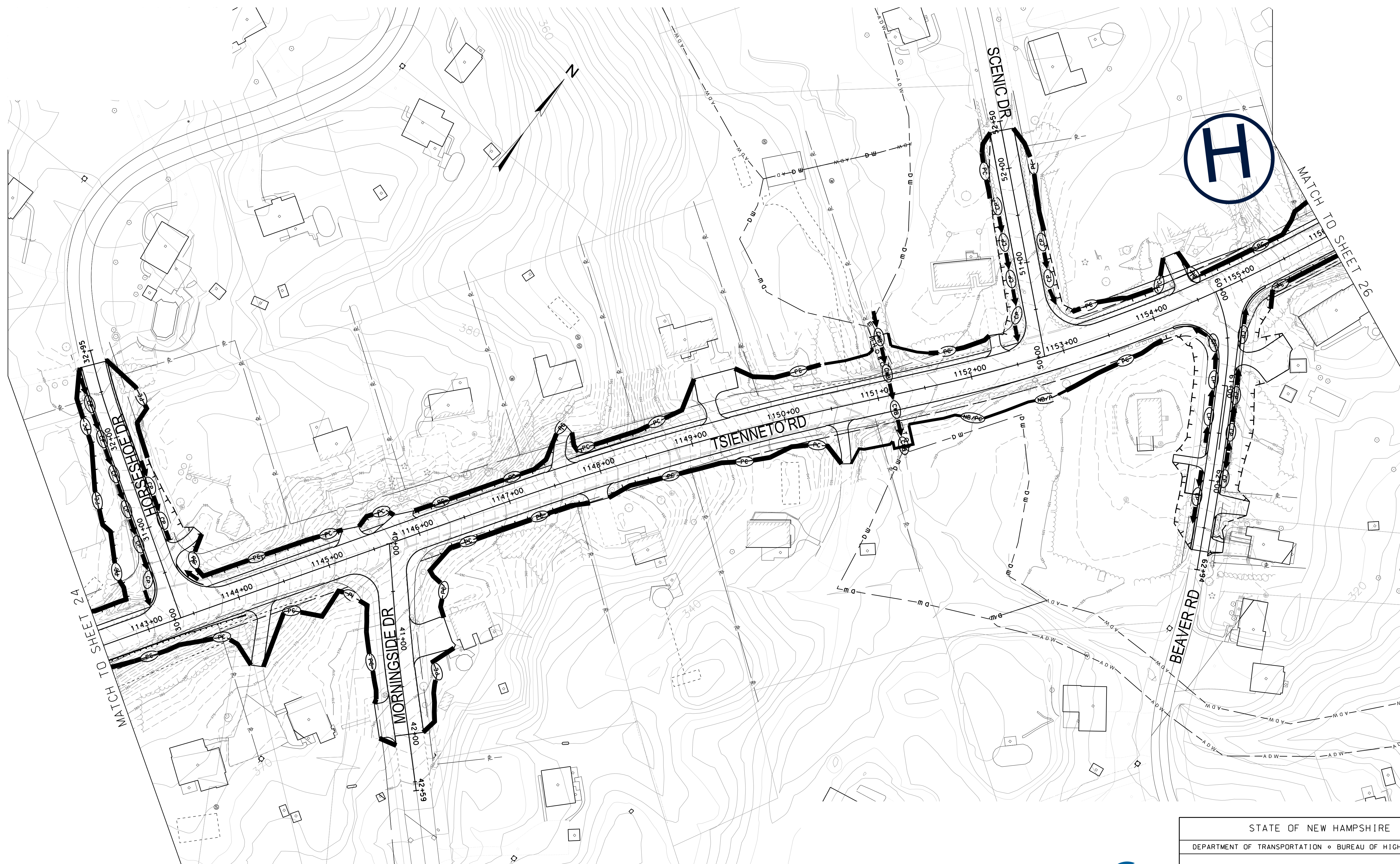

STATE OF NEW HAMPSHIRE			
DEPARTMENT OF TRANSPORTATION • BUREAU OF HIGHWAY DESIGN			
EXIT 4A			
EROSION CONTROL PLAN			
DGN	STATE PROJECT NO.	SHEET NO.	TOTAL SHEETS
13065EROPLANS	13065	26	28

SDR PROCESSED	DATE	11/01/2019
NEW DESIGN	EMM	
SHEET CHECKED	KAH	
AS BUILT DETAILS	DATE	

REVISIONS AFTER PROPOSAL	STATION	DESCRIPTION



STATE OF NEW HAMPSHIRE			
DEPARTMENT OF TRANSPORTATION • BUREAU OF HIGHWAY DESIGN			
EXIT 4A			
EROSION CONTROL PLAN			
DGN	STATE PROJECT NO.	SHEET NO.	TOTAL SHEETS
13065EROPLANS	13065	27	28



SDR PROCESSED	DATE	11/01/2019
NEW DESIGN	EMM	
SHEET CHECKED	KAH	
AS BUILT DETAILS	DATE	

REVISIONS AFTER PROPOSAL	STATION	DESCRIPTION

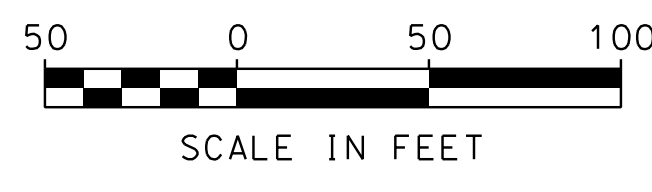
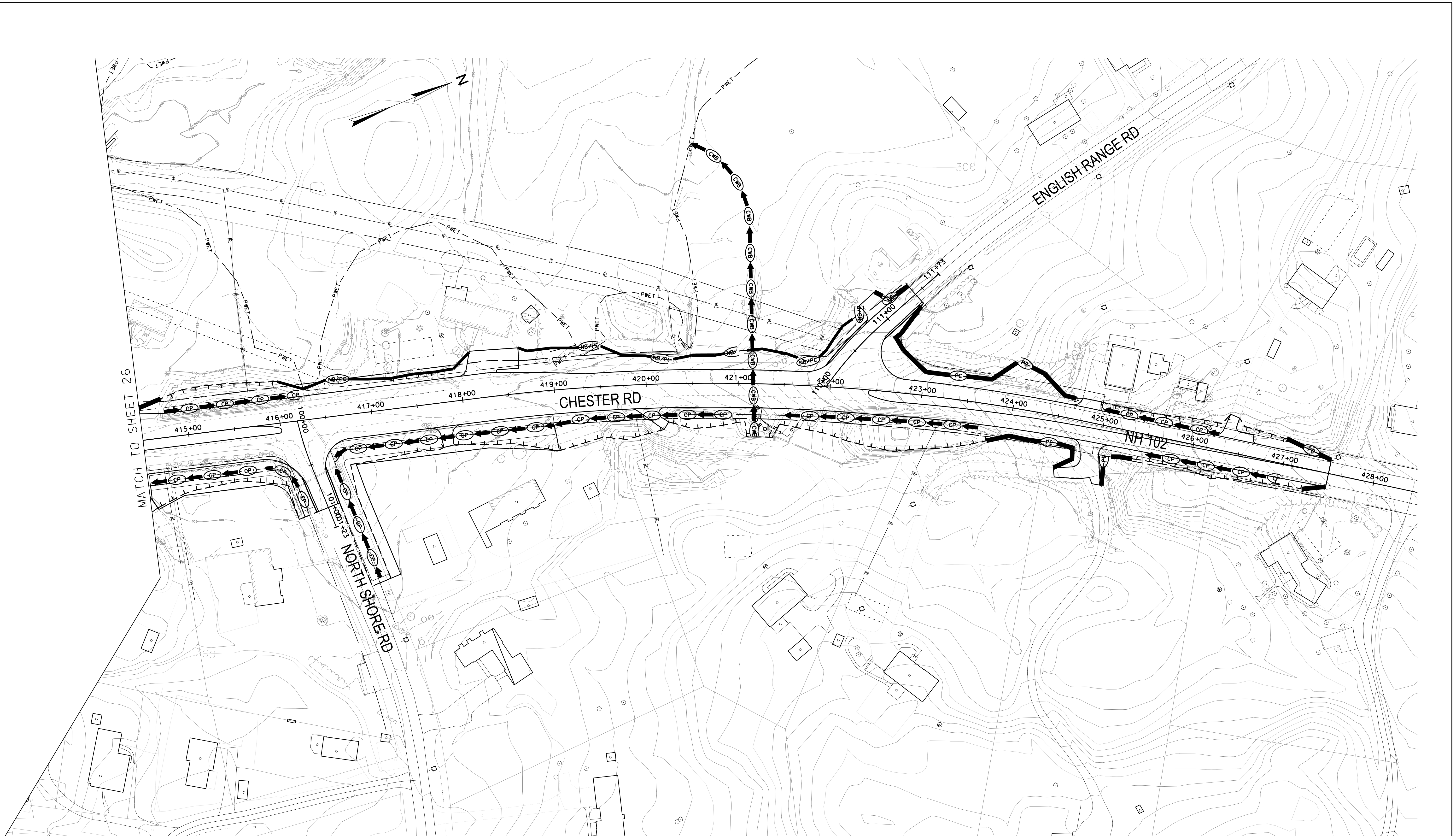

STATE OF NEW HAMPSHIRE			
DEPARTMENT OF TRANSPORTATION • BUREAU OF HIGHWAY DESIGN			
EXIT 4A			
EROSION CONTROL PLAN			
DGN	STATE PROJECT NO.	SHEET NO.	TOTAL SHEETS
13065EROPLANS	13065	28	28